

2017
Genel fiyat listesi

Rit 

YENİLİĐİ HİSSET
İŐIĐA Y N VER



TEKNOLOĐI VE TASARIMIN **YENİ MEKANİZMASI**

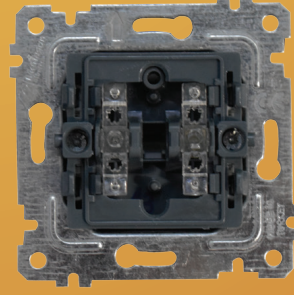
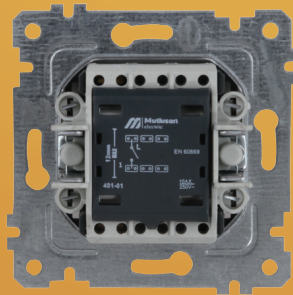

içindekiler

CANALEX
EKO SERİSİ
MEKS SERİSİ
FLARET
COMFORT
H.FREE SPIRALLER
COMFORT LED
MEKS PLUS
LED PANELLER



| | |
|-------------|----|
| Ritâ | 2 |
| Elitra Plus | 9 |
| Candelâ | 14 |
| Dariâ | 23 |
| BRON | 25 |
| Nemliyer | 27 |
| Fiş Prizler | 29 |

ANAHTAR

TESİSAT GRUBU

| | |
|---|----|
| Canalex serisi kapalı tip kablo kanalları | 36 |
| Eko serisi kapalı tip kablo kanalları | 36 |
| Yapışkan bantlı kapalı tip kablo kanalları | 36 |
| Kanal için UPS ve enerji prizleri 45x45 | 37 |
| Döşeme altı priz sistemleri | 37 |
| Meks serisi kapalı tip kablo kanalları | 37 |
| Meks plus serisi kapalı tip kablo kanalları | 37 |
| Meks serisi klima kanalı ve aksesuarları | 37 |
| Tavan köşe kanalı | 37 |
| Süpürgelik kablo kanalları | 37 |
| Fugalı süpürgelik | 37 |
| Tezgah süpürgeliği | 37 |
| Balık sırtı zemin kanalları | 37 |
| Kanal aksesuarları | 38 |
| Meks plus serisi için priz setleri | 39 |
| Sidem serisi renkli kablo kanalları | 39 |
| Sidem serisi süpürgelikler ve aksesuarları | 40 |
| Spiraller | 43 |
| Polyemid Spiral rekor ve dirsekler | 43 |
| H.free Spiraller | 43 |
| Kablo taplama ve pano spiralleri | 43 |
| Eko serisi çelik ve izole kaplı spiraller | 44 |
| Meks serisi çelik ve izole kaplı spiraller | 44 |
| Rakorlar | 44 |
| Borular | 45 |
| HDPE koruge borular | 45 |
| Plastik dirsek ve muflar | 45 |
| PVC boy borular ve muflar | 46 |
| PVC boy boru kroşeleri | 46 |
| Buatlar ve kapakları | 47 |
| Sustalar | 48 |
| Kofra-kesicili kofra ve buşonlar | 48 |
| Basınç şalterleri ve seviye flatörleri | 48 |
| Şalterler | 48 |
| Meksbox W otomat kutuları | 50 |
| Comfort W otomat kutuları | 51 |
| Comfort zayıf akım kutuları | 51 |
| Duyalar | 52 |
| Telefon kutuları ve aksesuarları | 52 |
| Kontrol kalemi, pense ve takım çantaları | 53 |
| Dübeller, vidalar ve kroşeler | 54 |
| Wago klemens ve ölçü aletleri | 56 |
| Klemensler | 57 |
| Merdiven otomatığı ve röleler | 58 |
| Ziller ve trafolar | 58 |
| Duman ve gaz dedektörleri | 58 |
| Döner, flaşör lambaları ve motorlu sirenler | 59 |
| Yangın ihbar ürünleri | 60 |
| Aspiratör ve sanayi tip vantilatörler | 62 |

AYDINLATMA GRUBU

| | |
|--|----|
| Led Paneller | 66 |
| Led Etanj Armatürler | 67 |
| Radar Sensörlü Armatürler | 70 |
| Wallwasher - Led Bar Armatürler | 72 |
| Sıvaaltı / Sıvaüstü T5 Lambalı Armatür | 74 |
| Sıvaaltı / Sıvaüstü T8 Lambalı Armatür | 74 |
| İthal Projektörler | 75 |
| Cadde Aydınlatma Armatürleri | 75 |
| Okul Tipi Armatürer | 75 |
| Etanj Armatür | 75 |
| Armatür Çeşitleri | 76 |
| Nemliyer Armatür Çeşitleri | 76 |
| Cam Armatür Çeşitleri | 81 |
| Bahçe Armatürleri | 86 |
| IP68 Park Bahçe Armatürleri | 87 |
| IP68 Su Geçirmez Rekorlar | 88 |
| Exit - Acil Aydınlatma Armatürü | 90 |

OTOMASYON GRUBU

| | |
|--|-----|
| Delikli kablo kanalları | 93 |
| Ray Klamensler | 94 |
| Raylar, izalatörler ve topraklama çubuğu | 94 |
| Kablo bağları ve etiketleri | 95 |
| Sıkmalı tip kablo pabuç ve penseleri | 96 |
| İzoleli yüksükler ve penseleri | 97 |
| Sinyal ve kumanda butonları | 98 |
| Etanj buton kutuları | 101 |
| Vinç kutuları | 101 |
| İkaz lambaları | 102 |
| Borulu kornalar | 106 |
| Termoplastik buatlar ve kombinasyon kutuları | 108 |
| Alev Yaymılan termoplastik buatlar | 108 |
| Logar kutuları | 110 |
| Plastik opak ve etanj panolar | 110 |
| Sanayi tipi kauçuk fiş ve prizleri | 112 |
| Çoklu grup prizler | 115 |
| Seyyar el lambaları ve kablo makaraları | 115 |
| Sanayi tipi fiş ve prizleri | 115 |
| Reçineli kablo başlıkları | 116 |
| Isı ile daralan makaronlar | 116 |



ISO 9001:2008





Rita

RITA
ELITRA
ANDELA
ELITRA

NEMLIYER

OLIMPIA

LIVA

FIS PRIZLER

BRON
ELITRA PLUS

RITA

NEMLIYER

OLIMPIA

LIVA

FIS PRIZLER

BR

| Kod | Ürün Tanımı | Kutu Adedi | Koli Adedi | Fiyat |
|-----|-------------|------------|------------|-------|
|-----|-------------|------------|------------|-------|

Anahtar Grubu Vidalı Tip

| | | | | |
|---------------|---|----|-----|-------|
| 2200 401 02XX | Rita Mek+Tuş Anahtar (Vidalı) | 12 | 120 | 5.46 |
| 2200 402 02XX | Rita Mek+Tuş Komütatör (Vidalı) | 12 | 120 | 7.42 |
| 2200 403 02XX | Rita Mek+Tuş Vavien (İki Yollu Anahtar)(Vidalı) | 12 | 120 | 7.85 |
| 2200 404 02XX | Rita Mek+Tuş Komütatör Vavien (Vidalı) | 12 | 120 | 12.44 |
| 2200 405 02XX | Rita Mek+Tuş Çift Kutuplu Anahtar (Vidalı) | 12 | 120 | 8.30 |
| 2200 406 02XX | Rita Mek+Tuş Jaluzi Anahtar (Vidalı) | 12 | 120 | 11.85 |
| 2200 407 02XX | Rita Mek+Tuş Çaçırma (Vidalı) | 12 | 120 | 7.56 |
| 2200 407 02XX | Rita Mek+Tuş Kapı Otomatığı Anahtar (Vidalı) | 12 | 120 | 7.56 |
| 2200 407 02XX | Rita Mek+Tuş Zil Anahtar (Vidalı) | 12 | 120 | 7.56 |
| 2200 408 02XX | Rita Mek+Tuş Deviatör(Ara Vavien)(Vidalı) | 12 | 120 | 11.50 |
| 2200 409 02XX | Rita Mek+Tuş Üçlü Anahtar (Vidalı) | 12 | 120 | 11.11 |
| 2200 411 02XX | Rita Mek+Tuş Sofben Anahtar (Vidalı) | 12 | 120 | 8.02 |
| 2200 415 02XX | Rita Mek+Tuş Işıklı Anahtar (220V) (Vidalı) | 12 | 120 | 10.67 |
| 2200 416 02XX | Rita Mek+Tuş Işıklı Vavien (220V) (Vidalı) | 12 | 120 | 12.59 |
| 2200 417 02XX | Rita Mek+Tuş Işıklı Çaçırma (220V)(Vidalı) | 12 | 120 | 10.96 |
| 2200 418 02XX | Rita Mek+Tuş Işıklı Etik. Anahtar (220V)(Vidalı) | 12 | 120 | 11.11 |
| 2200 419 02XX | Rita Mek+Tuş Işıklı Etik. Çaçırma (220V)(Vidalı) | 12 | 120 | 11.26 |
| 2200 422 02XX | Rita Mek+Tuş Işıklı Zil Etik. Çaçırma (12V)(Vidalı) | 12 | 120 | 10.76 |
| 2200 426 02XX | Rita Mek+Tuş Işıklı Komütatör (Vidalı) | 12 | 120 | 13.93 |

Anahtar Grubu Klipsli Tip (Kolay Bağlantı)

| | | | | |
|---------------|--|----|-----|-------|
| 2200 401 01XX | Rita Mek+Tuş Anahtar (Klipsli) | 12 | 120 | 5.46 |
| 2200 402 01XX | Rita Mek+Tuş Komütatör (Klipsli) | 12 | 120 | 7.42 |
| 2200 403 01XX | Rita Mek+Tuş Vavien (İki Yollu Anahtar)(Klipsli) | 12 | 120 | 7.85 |
| 2200 404 01XX | Rita Mek+Tuş Komütatör Vavien (Klipsli) | 12 | 120 | 12.44 |
| 2200 405 01XX | Rita Mek+Tuş Çift Kutuplu Anahtar (Klipsli) | 12 | 120 | 8.30 |
| 2200 406 01XX | Rita Mek+Tuş Jaluzi Anahtar (Klipsli) | 12 | 120 | 11.85 |
| 2200 407 01XX | Rita Mek+Tuş Çaçırma (Klipsli) | 12 | 120 | 7.56 |
| 2200 407 01XX | Rita Mek+Tuş Kapı Otomatığı Anahtar(Klipsli) | 12 | 120 | 7.56 |
| 2200 407 01XX | Rita Mek+Tuş Zil Anahtar(Klipsli) | 12 | 120 | 7.56 |
| 2200 408 01XX | Rita Mek+Tuş Deviatör(Ara Vavien)(Klipsli) | 12 | 120 | 11.50 |
| 2200 409 01XX | Rita Mek+Tuş Üçlü Anahtar (Klipsli) | 12 | 120 | 11.11 |
| 2200 415 01XX | Rita Mek+Tuş Işıklı Anahtar (220V) (Klipsli) | 12 | 120 | 10.67 |
| 2200 416 01XX | Rita Mek+Tuş Işıklı Vavien (220V) (Klipsli) | 12 | 120 | 12.59 |
| 2200 417 01XX | Rita Mek+Tuş Işıklı Çaçırma (220V)(Klipsli) | 12 | 120 | 10.96 |
| 2200 418 01XX | Rita Mek+Tuş Işıklı Etik. Anahtar (220V)(Klipsli) | 12 | 120 | 11.11 |
| 2200 419 01XX | Rita Mek+Tuş Işıklı Etik. Çaçırma (220V)(Klipsli) | 12 | 120 | 11.26 |
| 2200 422 01XX | Rita Mek+Tuş Işıklı Zil Etik. Çaçırma (12V)(Klipsli) | 12 | 120 | 10.76 |
| 2200 426 01XX | Rita Mek+Tuş Işıklı Komütatör (Klipsli) | 12 | 120 | 13.93 |

Dimmer Grubu

| | | | | |
|---------------|-------------------------------------|---|----|-------|
| 2200 440 02XX | Rita Mek+Tuş RL Işıklı Dimmer 600W | 8 | 80 | 49.57 |
| 2200 444 02XX | Rita Mek+Tuş RI Işıklı Dimmer 1000W | 8 | 80 | 62.22 |

Elektronik Grubu

| | | | | |
|---------------|--|----|-----|-------|
| 2200 450 01XX | Rita Mek+Tuş Energy Saver G.sız Işıklı | 8 | 80 | 71.11 |
| 2200 452 01XX | Rita Mek+Tuş Energy Saver Gecikmeli Işıklı | 8 | 80 | 71.11 |
| 2200 470 02XX | Rita Mek+Tuş Müzik Yayın Anahtar | 8 | 80 | 54.81 |
| 2200 480 01XX | Rita Mek+Tuş Hoparlör Prizi | 12 | 120 | 10.00 |
| 2200 485 02XX | Rita Mek+Tuş Uyan Zili | 12 | 120 | 42.96 |
| 2200 495 02XX | Rita Mek+Tuş Hareket Sensörü | 12 | 120 | 82.96 |

Priz Grubu

| | | | | |
|---------------|---|----|-----|-------|
| 2200 100 02XX | Rita Mek+Tuş Topraklı Priz | 12 | 120 | 6.52 |
| 2200 101 02XX | Rita Mek+Tuş Topraksız Priz | 12 | 120 | 5.84 |
| 2200 105 02XX | Rita Mek+Tuş Topraklı Priz (Çocuk Kor.) | 12 | 120 | 8.59 |
| 2200 106 02XX | Rita Mek+Tuş Topraksız Priz (Çocuk Kor.) | 12 | 120 | 7.56 |
| 2200 110 02XX | Rita Mek+Tuş Kapaklı Topraklı Priz | 12 | 120 | 8.00 |
| 2200 111 02XX | Rita Mek+Tuş Kapaklı Topraklı Priz (Çocuk Kor.) | 12 | 120 | 10.07 |
| 2200 115 02XX | Rita Mek+Tuş Ups (Fransız) Prizi | 12 | 120 | 8.00 |
| 2200 116 02XX | Rita Mek+Tuş Ups (Fransız) Prizi (Çocuk Kor.) | 12 | 120 | 9.54 |
| 2200 117 02XX | Rita Mek+Tuş Ups Kapaklı (Fransız) Priz | 12 | 120 | 9.71 |
| 2200 118 02XX | Rita Mek+Tuş Ups Kapaklı (Fr.) Priz (Çoc. Kor.) | 12 | 120 | 9.93 |
| 2200 200 02XX | Rita Mek+Tuş İkili Topraklı Priz Porselen | 12 | 120 | 10.92 |
| 2200 201 02XX | Rita Mek+Tuş İkili Topraksız Priz Porselen | 5 | 50 | 9.06 |
| 2200 202 02XX | Rita Mek+Tuş İkili Topraklı Priz | 5 | 50 | 9.73 |
| 2200 203 02XX | Rita Mek+Tuş İkili Topraksız Priz | 5 | 50 | 7.77 |
| 2200 215 02XX | Rita Mek+Tuş İkili Ups Priz | 5 | 50 | 11.50 |
| 2200 448 01XX | Rita Mek+Tuş Tekli Usb Şarj Prizi | 5 | 50 | 58.90 |
| 2200 449 01XX | Rita Mek+Tuş İkili Usb Şarj Prizi | 5 | 50 | 60.25 |



| Kod | Ürün Tanımı | Kutu Adedi | Koli Adedi | Fiyat |
|-----------------------|--|------------|------------|-------|
| İletişim Grubu | | | | |
| 2200 125 01XX | Rita Mek+Tuş Telefon Prizi 1Xrj12 (Cat3) | 12 | 120 | 9.93 |
| 2200 126 01XX | Rita Mek+Tuş Telefon Prizi 2Xrj12 (Cat3) | 12 | 120 | 13.78 |
| 2200 128 01XX | Rita Mek+Tuş Etiketli Tlf Data Priz (Kon.süz) | 12 | 120 | 5.93 |
| 2200 135 02XX | Rita Mek+Tuş Data Prizi 1*Rj45 (Kon.süz) | 12 | 120 | 5.63 |
| 2200 136 01XX | Rita Mek+Tuş Data Prizi 1*Rj45 (Cat5e) | 12 | 120 | 16.30 |
| 2200 137 01XX | Rita Mek+Tuş Data Prizi 2*Rj45 (Kon.süz) | 12 | 120 | 6.22 |
| 2200 138 01XX | Rita Mek+Tuş Data Prizi 2*Rj45 (Cat5e) | 12 | 120 | 26.67 |
| 2200 139 01XX | Rita Mek+Tuş Tlf Data Priz (Rj12 Cat3 + Cat5e) | 12 | 120 | 21.63 |
| 2200 140 01XX | Rita Mek+Tuş Data Prizi 1*Rj45 (Cat6) | 12 | 120 | 17.94 |
| 2200 141 01XX | Rita Mek+Tuş Data Prizi 2*Rj45 (Cat6) | 12 | 120 | 32.34 |
| 2200 455 01XX | Rita Mek+Tuş Data Prizi 1*Usb | 12 | 120 | 24.59 |
| 2200 456 01XX | Rita Mek+Tuş Data Prizi 2*Usb | 12 | 120 | 42.86 |
| 2200 457 01XX | Rita Mek+Tuş Data Prizi 1*Hdmı | 12 | 120 | 30.81 |
| 2200 458 01XX | Rita Mek+Tuş Data Prizi 2*Hdmı | 12 | 120 | 54.99 |
| 2200 459 01XX | Rita Mek+Tuş Data Prizi 1*Usb/1*Hdmı | 12 | 120 | 48.13 |
| 2200 460 02XX | Rita Mek+Tuş VGA Priz | 12 | 120 | 48.00 |
| 2200 121 02XX | Rita Mek+Tuş Kör Kapak | 12 | 120 | 5.33 |

TV / Sat Grubu

| | | | | |
|---------------|--|----|-----|-------|
| 2200 156 02XX | Rita Mek+Tuş Tv-Sat Prizi (Geçişli) 4DB/F Kon. | 12 | 120 | 39.84 |
| 2200 157 02XX | Rita Mek+Tuş Tv-Sat Prizi (Sonlu) | 12 | 120 | 39.84 |
| 2200 166 01XX | Rita Mek+Tuş Sat Prizi (Geçişli) 4DB/F Konnektör | 12 | 120 | 20.74 |
| 2200 167 01XX | Rita Mek+Tuş Sat Prizi (Sonlu) | 12 | 120 | 20.74 |
| 2200 170 01XX | Rita Mek+Tuş Tv Prizi (Geçişli) 11DB | 12 | 120 | 12.54 |
| 2200 171 01XX | Rita Mek+Tuş Tv Prizi (Sonlu) | 12 | 120 | 12.54 |
| 2200 172 01XX | Rita Mek+Tuş Tv Prizi F Dişi | 12 | 120 | 7.85 |



Beyaz 01
Krem 02

Çerçeveler

| | | | | |
|---------------|---------------------------|----|-----|------|
| 2220 800 11XX | Rita Tekli Çerçeve | 20 | 400 | 1.11 |
| 2220 800 12XX | Rita İkili Yatay Çerçeve | 10 | 200 | 3.46 |
| 2220 800 13XX | Rita Üçlü Yatay Çerçeve | 10 | 50 | 4.44 |
| 2220 800 14XX | Rita Dörtlü Yatay Çerçeve | 10 | 50 | 5.48 |
| 2220 800 15XX | Rita Beşli Yatay Çerçeve | 10 | 50 | 6.96 |
| 2220 800 16XX | Rita Altılı Yatay Çerçeve | 10 | 50 | 9.19 |
| 2220 800 22XX | Rita İkili Dikey Çerçeve | 10 | 50 | 3.46 |
| 2220 800 23XX | Rita Üçlü Dikey Çerçeve | 10 | 50 | 4.44 |
| 2220 800 24XX | Rita Dörtlü Dikey Çerçeve | 10 | 50 | 5.48 |
| 2220 800 25XX | Rita Beşli Dikey Çerçeve | 10 | 50 | 6.96 |
| 2220 800 26XX | Rita Altılı Dikey Çerçeve | 10 | 50 | 9.19 |
| 2220 820 12XX | Rita İkili Priz Çerçeve | 12 | 60 | 1.57 |

► RİTA PASTEL**Çerçeveler**

| | | | | |
|---------------|---------------------------|----|-----|-------|
| 2220 800 11XX | Rita Tekli Çerçeve | 20 | 400 | 2.06 |
| 2220 800 12XX | Rita İkili Yatay Çerçeve | 10 | 200 | 6.41 |
| 2220 800 13XX | Rita Üçlü Yatay Çerçeve | 10 | 50 | 8.23 |
| 2220 800 14XX | Rita Dörtlü Yatay Çerçeve | 10 | 50 | 10.15 |
| 2220 800 15XX | Rita Beşli Yatay Çerçeve | 10 | 50 | 12.89 |
| 2220 800 16XX | Rita Altılı Yatay Çerçeve | 10 | 50 | 17.01 |
| 2220 800 22XX | Rita İkili Dikey Çerçeve | 10 | 50 | 6.41 |
| 2220 800 23XX | Rita Üçlü Dikey Çerçeve | 10 | 50 | 8.23 |
| 2220 800 24XX | Rita Dörtlü Dikey Çerçeve | 10 | 50 | 10.15 |
| 2220 800 25XX | Rita Beşli Dikey Çerçeve | 10 | 50 | 12.89 |
| 2220 800 26XX | Rita Altılı Dikey Çerçeve | 10 | 50 | 17.01 |
| 2100 000 11XX | Sıva Üstü Kasa | 12 | 60 | 1.57 |

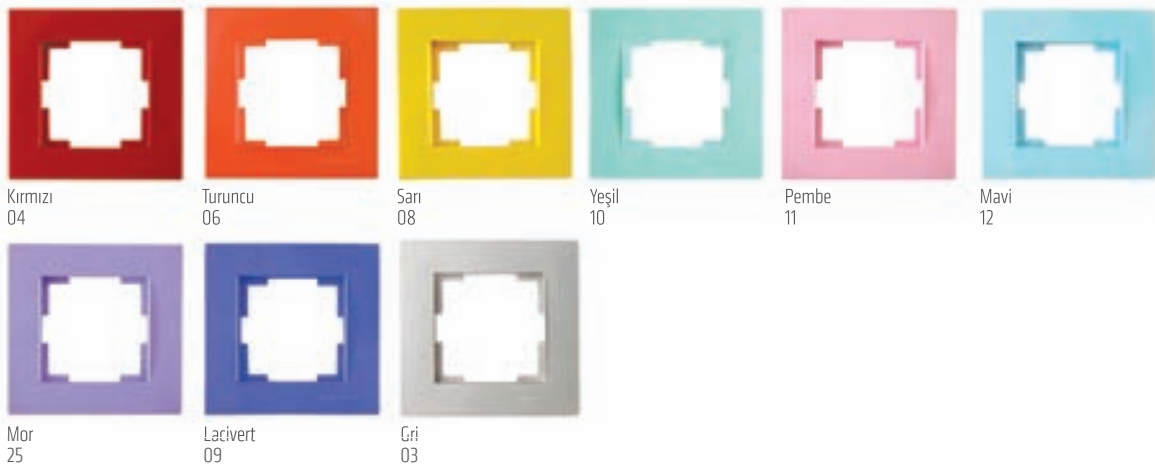



| Kod | Ürün Tanımı | Kutu Adedi | Koli Adedi | Fiyat |
|-----|-------------|------------|------------|-------|
|-----|-------------|------------|------------|-------|

Anahtar Grubu Vidalı Tip

| | | | | |
|----------------|---|----|-----|-------|
| 2200 401 02XX | Rita Mek+Tuş Anahtar (Vidalı) | 12 | 120 | 8.59 |
| 2200 402 02XX | Rita Mek+Tuş Komütatör (Vidalı) | 12 | 120 | 10.22 |
| 2200 403 02XX | Rita Mek+Tuş Vavien (İki Yollu Anahtar)(Vidalı) | 12 | 120 | 10.13 |
| 2200 404 02XX | Rita Mek+Tuş Komütatör Vavien (Vidalı) | 12 | 120 | 14.95 |
| 2200 405 02XX | Rita Mek+Tuş Çift Kutuplu Anahtar (Vidalı) | 12 | 120 | 10.22 |
| 2200 406 02XX | Rita Mek+Tuş Jaluzi Anahtar (Vidalı) | 12 | 120 | 15.32 |
| 2200 407 02XX | Rita Mek+Tuş Çaçırma (Vidalı) | 12 | 120 | 9.51 |
| 2200 407 02XXK | Rita Mek+Tuş Kapı Otomatığı Anahtar (Vidalı) | 12 | 120 | 9.51 |
| 2200 407 02XXZ | Rita Mek+Tuş Zil Anahtar (Vidalı) | 12 | 120 | 9.51 |
| 2200 408 02XX | Rita Mek+Tuş Deviyatör (Ara Vavien)(Vidalı) | 12 | 120 | 14.67 |
| 2200 409 02XX | Rita Mek+Tuş Üçlü Anahtar (Vidalı) | 12 | 120 | 15.09 |
| 2200 411 02XX | Rita Mek+Tuş Sofben Anahtar (Vidalı) | 12 | 120 | 10.43 |
| 2200 415 02XX | Rita Mek+Tuş Işıklı Anahtar (220V) (Vidalı) | 12 | 120 | 13.55 |
| 2200 416 02XX | Rita Mek+Tuş Işıklı Vavien (220V) (Vidalı) | 12 | 120 | 14.52 |
| 2200 417 02XX | Rita Mek+Tuş Işıklı Çaçırma (220V)(Vidalı) | 12 | 120 | 14.84 |
| 2200 418 02XX | Rita Mek+Tuş Işıklı Etik. Anahtar (220V)(Vidalı) | 12 | 120 | 12.74 |
| 2200 419 02XX | Rita Mek+Tuş Işıklı Etik. Çaçırma (220V)(Vidalı) | 12 | 120 | 12.74 |
| 2200 422 02XX | Rita Mek+Tuş Işıklı Zil Etik. Çaçırma (12V)(Vidalı) | 12 | 120 | 12.74 |
| 2200 426 02XX | Rita Mek+Tuş Işıklı Komütatör (Vidalı) | 12 | 120 | 16.78 |

Anahtar Grubu Klipsli Tip (Kolay Bağlantı)

| | | | | |
|----------------|--|----|-----|-------|
| 2200 401 01XX | Rita Mek+Tuş Anahtar (Klipsli) | 12 | 120 | 8.59 |
| 2200 402 01XX | Rita Mek+Tuş Komütatör (Klipsli) | 12 | 120 | 10.22 |
| 2200 403 01XX | Rita Mek+Tuş Vavien (İki Yollu Anahtar)(Klipsli) | 12 | 120 | 10.13 |
| 2200 404 01XX | Rita Mek+Tuş Komütatör Vavien (Klipsli) | 12 | 120 | 14.95 |
| 2200 405 01XX | Rita Mek+Tuş Çift Kutuplu Anahtar (Klipsli) | 12 | 120 | 10.22 |
| 2200 406 01XX | Rita Mek+Tuş Jaluzi Anahtar (Klipsli) | 12 | 120 | 15.32 |
| 2200 407 01XX | Rita Mek+Tuş Çaçırma (Klipsli) | 12 | 120 | 9.51 |
| 2200 407 01XXK | Rita Mek+Tuş Kapı Otomatığı Anahtar(Klipsli) | 12 | 120 | 9.51 |
| 2200 407 01XXZ | Rita Mek+Tuş Zil Anahtar(Klipsli) | 12 | 120 | 9.51 |
| 2200 408 01XX | Rita Mek+Tuş Deviyatör(Ara Vavien)(Klipsli) | 12 | 120 | 14.67 |
| 2200 409 01XX | Rita Mek+Tuş Üçlü Anahtar (Klipsli) | 12 | 120 | 15.09 |
| 2200 415 01XX | Rita Mek+Tuş Işıklı Anahtar (220V) (Klipsli) | 12 | 120 | 13.55 |
| 2200 416 01XX | Rita Mek+Tuş Işıklı Vavien (220V) (Klipsli) | 12 | 120 | 14.52 |
| 2200 417 01XX | Rita Mek+Tuş Işıklı Çaçırma (220V)(Klipsli) | 12 | 120 | 14.84 |
| 2200 418 01XX | Rita Mek+Tuş Işıklı Etik. Anahtar (220V)(Klipsli) | 12 | 120 | 12.74 |
| 2200 419 01XX | Rita Mek+Tuş Işıklı Etik. Çaçırma (220V)(Klipsli) | 12 | 120 | 12.74 |
| 2200 422 01XX | Rita Mek+Tuş Işıklı Zil Etik. Çaçırma (12V)(Klipsli) | 12 | 120 | 12.74 |
| 2200 426 01XX | Rita Mek+Tuş Işıklı Komütatör (Klipsli) | 12 | 120 | 16.78 |

Dimmer Grubu

| | | | | |
|---------------|-------------------------------------|---|----|-------|
| 2200 440 02XX | Rita Mek+Tuş RL Işıklı Dimmer 600W | 8 | 80 | 50.92 |
| 2200 444 02XX | Rita Mek+Tuş RI Işıklı Dimmer 1000W | 8 | 80 | 64.12 |

Elektronik Grubu

| | | | | |
|---------------|--|----|-----|-------|
| 2200 450 01XX | Rita Mek+Tuş Energy Saver G.sız Işıklı | 8 | 80 | 73.42 |
| 2200 452 01XX | Rita Mek+Tuş Energy Saver Gecikmeli Işıklı | 8 | 80 | 73.42 |
| 2200 470 02XX | Rita Mek+Tuş Müzik Yayın Anahtar | 8 | 80 | 62.42 |
| 2200 480 01XX | Rita Mek+Tuş Hoparlör Prizi | 12 | 120 | 27.44 |
| 2200 485 02XX | Rita Mek+Tuş Uyarı Zili | 12 | 120 | 48.80 |
| 2200 495 02XX | Rita Mek+Tuş Hareket Sensörü | 12 | 120 | 96.30 |

Priz Grubu

| | | | | |
|---------------|---|----|-----|-------|
| 2200 100 02XX | Rita Mek+Tuş Topraklı Priz | 12 | 120 | 9.75 |
| 2200 101 02XX | Rita Mek+Tuş Topraksız Priz | 12 | 120 | 8.65 |
| 2200 105 02XX | Rita Mek+Tuş Topraklı Priz (Çocuk Kor.) | 12 | 120 | 13.19 |
| 2200 106 02XX | Rita Mek+Tuş Topraksız Priz (Çocuk Kor.) | 12 | 120 | 11.54 |
| 2200 110 02XX | Rita Mek+Tuş Kapaklı Topraklı Priz | 12 | 120 | 10.73 |
| 2200 111 02XX | Rita Mek+Tuş Kapaklı Topraklı Priz (Çocuk Kor.) | 12 | 120 | 15.22 |
| 2200 115 02XX | Rita Mek+Tuş Ups (Fransız) Prizi | 12 | 120 | 13.93 |
| 2200 116 02XX | Rita Mek+Tuş Ups (Fransız) Prizi (Çocuk Kor.) | 12 | 120 | 15.32 |
| 2200 117 02XX | Rita Mek+Tuş Ups Kapaklı (Fransız) Priz | 12 | 120 | 16.37 |
| 2200 118 02XX | Rita Mek+Tuş Ups Kapaklı (Fr.) Priz (Çoc. Kor.) | 12 | 120 | 18.23 |
| 2200 200 02XX | Rita Mek+Tuş İkili Topraklı Priz Porselen | 12 | 120 | 14.33 |
| 2200 201 02XX | Rita Mek+Tuş İkili Topraksız Priz Porselen | 5 | 50 | 13.33 |
| 2200 202 02XX | Rita Mek+Tuş İkili Topraklı Priz | 5 | 50 | 12.89 |
| 2200 203 02XX | Rita Mek+Tuş İkili Topraksız Priz | 5 | 50 | 10.37 |
| 2200 215 02XX | Rita Mek+Tuş İkili Ups Priz | 5 | 50 | 14.81 |
| 2200 448 01XX | Rita Mek+Tuş Tekli Usb Şarj Prizi | 5 | 50 | 65.00 |
| 2200 449 01XX | Rita Mek+Tuş İkili Usb Şarj Prizi | 5 | 50 | 66.85 |

| Kod | Ürün Tanımı | Kutu Adedi | Koli Adedi | Fiyat |
|-----------------------|--|------------|------------|-------|
| İletişim Grubu | | | | |
| 2200 125 01XX | Rita Mek+Tuş Telefon Prizi 1Xrj12 (Cat3) | 12 | 120 | 11.85 |
| 2200 126 01XX | Rita Mek+Tuş Telefon Prizi 2Xrj12 (Cat3) | 12 | 120 | 17.48 |
| 2200 135 01XX | Rita Mek+Tuş Etiketli Tlf Data Priz (Kon.süz) | 12 | 120 | 8.23 |
| 2200 203 02XX | Rita Mek+Tuş Data Prizi 1*Rj45 (Kon.süz) | 12 | 120 | 7.84 |
| 2200 136 01XX | Rita Mek+Tuş Data Prizi 1*Rj45 (Cat5e) | 12 | 120 | 24.89 |
| 2200 137 01XX | Rita Mek+Tuş Data Prizi 2*Rj45 (Kon.süz) | 12 | 120 | 7.85 |
| 2200 138 01XX | Rita Mek+Tuş Data Prizi 2*Rj45 (Cat5e) | 12 | 120 | 39.11 |
| 2200 139 01XX | Rita Mek+Tuş Tlf Data Priz (Rj12 Cat3 + Cat5e) | 12 | 120 | 34.25 |
| 2200 140 01XX | Rita Mek+Tuş Data Prizi 1*Rj45 (Cat6) | 12 | 120 | 24.89 |
| 2200 141 01XX | Rita Mek+Tuş Data Prizi 2*Rj45 (Cat6) | 12 | 120 | 39.11 |
| 2200 455 01XX | Rita Mek+Tuş Data Prizi 1*Usb | 12 | 120 | 24.74 |
| 2200 456 01XX | Rita Mek+Tuş Data Prizi 2*Usb | 12 | 120 | 42.14 |
| 2200 457 01XX | Rita Mek+Tuş Data Prizi 1*Hdmı | 12 | 120 | 31.11 |
| 2200 458 01XX | Rita Mek+Tuş Data Prizi 2*Hdmı | 12 | 120 | 54.54 |
| 2200 459 01XX | Rita Mek+Tuş Data Prizi 1*Usb/1*Hdmı | 12 | 120 | 47.88 |
| 2200 460 01XX | Rita Mek+Tuş VGA Priz | 12 | 120 | 82.30 |
| 2200 121 02XX | Rita Mek+Tuş Kör Kapak | 12 | 120 | 12.12 |

TV / Sat Grubu

| | | | | |
|---------------|--|----|-----|-------|
| 2200 156 02XX | Rita Mek+Tuş Tv-Sat Prizi (Geçişli) 4DB/F Kon. | 12 | 120 | 48.31 |
| 2200 157 02XX | Rita Mek+Tuş Tv-Sat Prizi (Sonlu) | 12 | 120 | 48.31 |
| 2200 166 01XX | Rita Mek+Tuş Sat Prizi (Geçişli) 4DB/F Konnektör | 12 | 120 | 25.99 |
| 2200 167 01XX | Rita Mek+Tuş Sat Prizi (Sonlu) | 12 | 120 | 25.99 |
| 2200 170 01XX | Rita Mek+Tuş Tv Prizi (Geçişli) 11DB | 12 | 120 | 14.70 |
| 2200 171 01XX | Rita Mek+Tuş Tv Prizi (Sonlu) | 12 | 120 | 14.70 |
| 2200 172 01XX | Rita Mek+Tuş Tv Prizi F Dişi | 12 | 120 | 8.00 |

Çerçeveler

| | | | | |
|---------------|---------------------------|----|-----|-------|
| 2220 800 11XX | Rita Tekli Çerçeve | 20 | 400 | 2.33 |
| 2220 800 12XX | Rita İkili Yatay Çerçeve | 10 | 200 | 4.30 |
| 2220 800 13XX | Rita Üçlü Yatay Çerçeve | 10 | 50 | 8.56 |
| 2220 800 14XX | Rita Dörtlü Yatay Çerçeve | 10 | 50 | 10.76 |
| 2220 800 15XX | Rita Beşli Yatay Çerçeve | 10 | 50 | 13.83 |
| 2220 800 16XX | Rita Altılı Yatay Çerçeve | 10 | 50 | 18.20 |
| 2220 800 22XX | Rita İkili Dikey Çerçeve | 10 | 50 | 4.30 |
| 2220 800 23XX | Rita Üçlü Dikey Çerçeve | 10 | 50 | 8.56 |
| 2220 800 24XX | Rita Dörtlü Dikey Çerçeve | 10 | 50 | 10.76 |
| 2220 800 25XX | Rita Beşli Dikey Çerçeve | 10 | 50 | 13.83 |
| 2220 800 26XX | Rita Altılı Dikey Çerçeve | 10 | 50 | 18.20 |
| 2100 000 11XX | Sıva Üstü Kasa | 12 | 60 | 5.85 |
| 2220 820 12XX | Rita İkili Priz Çerçeve | 12 | 60 | 3.85 |

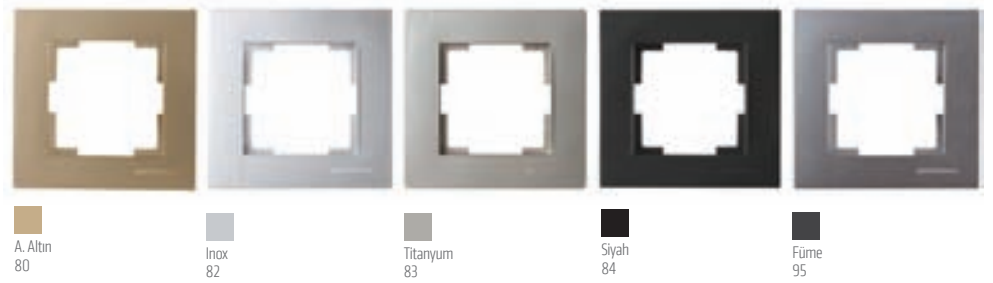

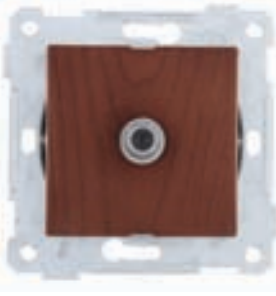

| Kod | Ürün Tanımı | Kutu Adedi | Koli Adedi | Fiyat |
|-----|-------------|------------|------------|-------|
|-----|-------------|------------|------------|-------|

Anahtar Grubu Vidalı Tip

| | | | | |
|---------------|---|----|-----|-------|
| 2200 401 02XX | Rita Mek+Tuş Anahtar (Vidalı) | 12 | 120 | 9.02 |
| 2200 402 02XX | Rita Mek+Tuş Komütatör (Vidalı) | 12 | 120 | 10.73 |
| 2200 403 02XX | Rita Mek+Tuş Vavien (İki Yollu Anahtar)(Vidalı) | 12 | 120 | 10.64 |
| 2200 404 02XX | Rita Mek+Tuş Komütatör Vavien (Vidalı) | 12 | 120 | 15.70 |
| 2200 405 02XX | Rita Mek+Tuş Çift Kutuplu Anahtar (Vidalı) | 12 | 120 | 10.73 |
| 2200 406 02XX | Rita Mek+Tuş Jaluzi Anahtar (Vidalı) | 12 | 120 | 16.08 |
| 2200 407 02XX | Rita Mek+Tuş Çaçırma (Vidalı) | 12 | 120 | 9.99 |
| 2200 407 02XX | Rita Mek+Tuş Kapı Otomatığı Anahtar (Vidalı) | 12 | 120 | 9.99 |
| 2200 407 02XX | Rita Mek+Tuş Zil Anahtar (Vidalı) | 12 | 120 | 9.99 |
| 2200 408 02XX | Rita Mek+Tuş Deviyatör(Ara Vavien)(Vidalı) | 12 | 120 | 15.41 |
| 2200 409 02XX | Rita Mek+Tuş Üçlü Anahtar (Vidalı) | 12 | 120 | 15.84 |
| 2200 411 02XX | Rita Mek+Tuş Şofben Anahtar (Vidalı) | 12 | 120 | 10.95 |
| 2200 415 02XX | Rita Mek+Tuş Işıklı Anahtar (220V) (Vidalı) | 12 | 120 | 14.23 |
| 2200 416 02XX | Rita Mek+Tuş Işıklı Vavien (220V) (Vidalı) | 12 | 120 | 15.24 |
| 2200 417 02XX | Rita Mek+Tuş Işıklı Çaçırma (220V)(Vidalı) | 12 | 120 | 15.58 |
| 2200 418 02XX | Rita Mek+Tuş Işıklı Etik. Anahtar (220V)(Vidalı) | 12 | 120 | 13.38 |
| 2200 419 02XX | Rita Mek+Tuş Işıklı Etik. Çaçırma (220V)(Vidalı) | 12 | 120 | 13.38 |
| 2200 422 02XX | Rita Mek+Tuş Işıklı Zil Etik. Çaçırma (12V)(Vidalı) | 12 | 120 | 13.38 |
| 2200 426 02XX | Rita Mek+Tuş Işıklı Komütatör (Vidalı) | 12 | 120 | 18.17 |

Anahtar Grubu Klipsli Tip (Kolay Bağlantı)

| | | | | |
|---------------|--|----|-----|-------|
| 2200 401 01XX | Rita Mek+Tuş Anahtar (Klipsli) | 12 | 120 | 9.02 |
| 2200 402 01XX | Rita Mek+Tuş Komütatör (Klipsli) | 12 | 120 | 10.73 |
| 2200 403 01XX | Rita Mek+Tuş Vavien (İki Yollu Anahtar)(Klipsli) | 12 | 120 | 10.64 |
| 2200 404 01XX | Rita Mek+Tuş Komütatör Vavien (Klipsli) | 12 | 120 | 15.70 |
| 2200 405 01XX | Rita Mek+Tuş Çift Kutuplu Anahtar (Klipsli) | 12 | 120 | 10.73 |
| 2200 406 01XX | Rita Mek+Tuş Jaluzi Anahtar (Klipsli) | 12 | 120 | 16.08 |
| 2200 407 01XX | Rita Mek+Tuş Çaçırma (Klipsli) | 12 | 120 | 9.99 |
| 2200 407 01XX | Rita Mek+Tuş Kapı Otomatığı Anahtar(Klipsli) | 12 | 120 | 9.99 |
| 2200 407 01XX | Rita Mek+Tuş Zil Anahtar(Klipsli) | 12 | 120 | 9.99 |
| 2200 408 01XX | Rita Mek+Tuş Deviyatör(Ara Vavien)(Klipsli) | 12 | 120 | 15.41 |
| 2200 409 01XX | Rita Mek+Tuş Üçlü Anahtar (Klipsli) | 12 | 120 | 15.84 |
| 2200 415 01XX | Rita Mek+Tuş Işıklı Anahtar (220V) (Klipsli) | 12 | 120 | 14.23 |
| 2200 416 01XX | Rita Mek+Tuş Işıklı Vavien (220V) (Klipsli) | 12 | 120 | 15.24 |
| 2200 417 01XX | Rita Mek+Tuş Işıklı Çaçırma (220V)(Klipsli) | 12 | 120 | 15.58 |
| 2200 418 01XX | Rita Mek+Tuş Işıklı Etik. Anahtar (220V)(Klipsli) | 12 | 120 | 13.38 |
| 2200 419 01XX | Rita Mek+Tuş Işıklı Etik. Çaçırma (220V)(Klipsli) | 12 | 120 | 13.38 |
| 2200 422 01XX | Rita Mek+Tuş Işıklı Zil Etik. Çaçırma (12V)(Klipsli) | 12 | 120 | 13.38 |
| 2200 426 01XX | Rita Mek+Tuş Işıklı Komütatör (Klipsli) | 12 | 120 | 18.17 |

Dimmer Grubu

| | | | | |
|---------------|-------------------------------------|---|----|-------|
| 2200 440 02XX | Rita Mek+Tuş RL Işıklı Dimmer 600W | 8 | 80 | 53.47 |
| 2200 444 02XX | Rita Mek+Tuş RI Işıklı Dimmer 1000W | 8 | 80 | 67.32 |

Elektronik Grubu

| | | | | |
|---------------|--|----|-----|--------|
| 2200 450 01XX | Rita Mek+Tuş Energy Saver G.siz Işıklı | 8 | 80 | 77.09 |
| 2200 452 01XX | Rita Mek+Tuş Energy Saver Gecikmeli Işıklı | 8 | 80 | 78.84 |
| 2200 470 02XX | Rita Mek+Tuş Müzik Yayın Anahtar | 8 | 80 | 65.54 |
| 2200 480 01XX | Rita Mek+Tuş Hoparlör Prizi | 12 | 120 | 28.81 |
| 2200 485 02XX | Rita Mek+Tuş Uyan Zili | 12 | 120 | 51.24 |
| 2200 495 02XX | Rita Mek+Tuş Hareket Sensörü | 12 | 120 | 101.11 |

Priz Grubu

| | | | | |
|---------------|---|----|-----|-------|
| 2200 100 02XX | Rita Mek+Tuş Topraklı Priz | 12 | 120 | 10.23 |
| 2200 101 02XX | Rita Mek+Tuş Topraksız Priz | 12 | 120 | 9.09 |
| 2200 105 02XX | Rita Mek+Tuş Topraklı Priz (Çocuk Kor.) | 12 | 120 | 15.41 |
| 2200 106 02XX | Rita Mek+Tuş Topraksız Priz (Çocuk Kor.) | 12 | 120 | 13.51 |
| 2200 110 02XX | Rita Mek+Tuş Kapaklı Topraklı Priz | 12 | 120 | 11.27 |
| 2200 111 02XX | Rita Mek+Tuş Kapaklı Topraklı Priz (Çocuk Kor.) | 12 | 120 | 16.23 |
| 2200 115 02XX | Rita Mek+Tuş Ups (Fransız) Prizi | 12 | 120 | 14.62 |
| 2200 116 02XX | Rita Mek+Tuş Ups (Fransız) Prizi (Çocuk Kor.) | 12 | 120 | 16.09 |
| 2200 117 02XX | Rita Mek+Tuş Ups Kapaklı (Fransız) Priz | 12 | 120 | 17.19 |
| 2200 118 02XX | Rita Mek+Tuş Ups Kapaklı (Fr.) Priz (Çoc. Kor.) | 12 | 120 | 19.15 |
| 2200 200 02XX | Rita Mek+Tuş İkili Topraklı Priz Porselen | 12 | 120 | 15.32 |
| 2200 201 02XX | Rita Mek+Tuş İkili Topraksız Priz Porselen | 5 | 50 | 14.24 |
| 2200 202 02XX | Rita Mek+Tuş İkili Topraklı Priz | 5 | 50 | 13.53 |
| 2200 203 02XX | Rita Mek+Tuş İkili Topraksız Priz | 5 | 50 | 10.89 |
| 2200 215 02XX | Rita Mek+Tuş İkili Ups Priz | 5 | 50 | 15.56 |
| 2200 448 01XX | Rita Mek+Tuş Tekli Usb Şarj Prizi | 5 | 50 | 73.70 |
| 2200 449 01XX | Rita Mek+Tuş İkili Usb Şarj Prizi | 5 | 50 | 75.80 |

| Kod | Ürün Tanımı | Kutu Adedi | Koli Adedi | Fiyat |
|-----------------------|--|------------|------------|-------|
| İletişim Grubu | | | | |
| 2200 125 01XX | Rita Mek+Tuş Telefon Prizi 1Xrj12 (Cat3) | 12 | 120 | 12.44 |
| 2200 126 01XX | Rita Mek+Tuş Telefon Prizi 2Xrj12 (Cat3) | 12 | 120 | 18.36 |
| 2200 128 01XX | Rita Mek+Tuş Etiketli Tlf Data Priz (Kon.süz) | 12 | 120 | 10.23 |
| 2200 135 02XX | Rita Mek+Tuş Data Prizi 1*Rj45 (Kon.süz) | 12 | 120 | 10.22 |
| 2200 136 01XX | Rita Mek+Tuş Data Prizi 1*Rj45 (Cat5e) | 12 | 120 | 26.13 |
| 2200 137 01XX | Rita Mek+Tuş Data Prizi 2*Rj45 (Kon.süz) | 12 | 120 | 10.22 |
| 2200 138 01XX | Rita Mek+Tuş Data Prizi 2*Rj45 (Cat5e) | 12 | 120 | 41.07 |
| 2200 139 01XX | Rita Mek+Tuş Tlf Data Priz (Rj12 Cat3 + Cat5e) | 12 | 120 | 35.97 |
| 2200 140 01XX | Rita Mek+Tuş Data Prizi 1*Rj45 (Cat6) | 12 | 120 | 26.13 |
| 2200 141 01XX | Rita Mek+Tuş Data Prizi 2*Rj45 (Cat6) | 12 | 120 | 41.07 |
| 2200 455 01XX | Rita Mek+Tuş Data Prizi 1*Usb | 12 | 120 | 25.98 |
| 2200 456 01XX | Rita Mek+Tuş Data Prizi 2*Usb | 12 | 120 | 44.25 |
| 2200 457 01XX | Rita Mek+Tuş Data Prizi 1*Hdmı | 12 | 120 | 32.67 |
| 2200 458 01XX | Rita Mek+Tuş Data Prizi 2*Hdmı | 12 | 120 | 57.26 |
| 2200 459 01XX | Rita Mek+Tuş Data Prizi 1*Usb/1*Hdmı | 12 | 120 | 50.28 |
| 2200 460 01XX | Rita Mek+Tuş VGA Prizi | 12 | 120 | 93.00 |
| 2200 121 02XX | Rita Mek+Tuş Kör Kapak | 12 | 120 | 12.73 |

TV / Sat Grubu

| | | | | |
|---------------|--|----|-----|-------|
| 2200 156 02XX | Rita Mek+Tuş Tv-Sat Prizi (Geçişli) 4DB/F Kon. | 12 | 120 | 50.72 |
| 2200 157 02XX | Rita Mek+Tuş Tv-Sat Prizi (Sonlu) | 12 | 120 | 50.72 |
| 2200 166 01XX | Rita Mek+Tuş Sat Prizi (Geçişli) 4DB/F Konnektör | 12 | 120 | 27.28 |
| 2200 167 01XX | Rita Mek+Tuş Sat Prizi (Sonlu) | 12 | 120 | 27.28 |
| 2200 170 01XX | Rita Mek+Tuş Tv Prizi (Geçişli) 11DB | 12 | 120 | 15.43 |
| 2200 171 01XX | Rita Mek+Tuş Tv Prizi (Sonlu) | 12 | 120 | 15.43 |
| 2200 172 01XX | Rita Mek+Tuş Tv Prizi F Dişi | 12 | 120 | 9.90 |

Çerçeveler

| | | | | |
|---------------|---------------------------|----|-----|-------|
| 2220 800 11XX | Rita Tekli Çerçeve | 20 | 400 | 4.30 |
| 2220 800 12XX | Rita İkili Yatay Çerçeve | 10 | 200 | 7.76 |
| 2220 800 13XX | Rita Uçlu Yatay Çerçeve | 10 | 50 | 10.49 |
| 2220 800 14XX | Rita Dörtlü Yatay Çerçeve | 10 | 50 | 13.33 |
| 2220 800 15XX | Rita Beşli Yatay Çerçeve | 10 | 50 | 14.96 |
| 2220 800 16XX | Rita Altılı Yatay Çerçeve | 10 | 50 | 20.09 |
| 2220 800 22XX | Rita İkili Dikey Çerçeve | 10 | 50 | 7.76 |
| 2220 800 23XX | Rita Uçlu Dikey Çerçeve | 10 | 50 | 10.49 |
| 2220 800 24XX | Rita Dörtlü Dikey Çerçeve | 10 | 50 | 13.33 |
| 2220 800 25XX | Rita Beşli Dikey Çerçeve | 10 | 50 | 14.96 |
| 2220 800 26XX | Rita Altılı Dikey Çerçeve | 10 | 50 | 20.09 |
| 2100 000 11XX | Siva Üstü Kasa | 12 | 60 | 6.76 |
| 2220 820 11XX | Rita İkili Priz Çerçeve | 12 | 60 | 7.26 |

Kiraz
56Ceviz
57Meşe
58



Elitra Plus



NEMLIYER

OLIMPIA

LIVA

FIS PRIZLER

BRON ELITRA PLUS

RITA

NEMLIYER

OLIMPIA

LIVA

FIS PRIZLER

BR

ELITRA

ANDELA

RITA DAF

BRON M



Elitra | Plus

Elitra Glass

► BEYAZ / SİYAH

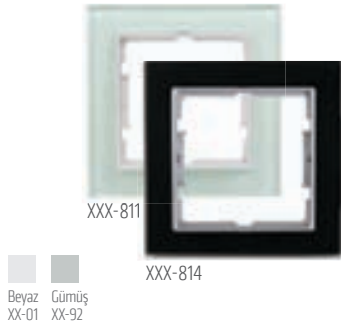

| Kod | Ürün Tanımı | Kutu Adedi | Fiyat |
|---------------|----------------------|------------|--------|
| 2170 XXX 11XX | Tekli Çerçeve | 10 | 42.11 |
| 2170 XXX 12XX | Yatay İkili Çerçeve | 10 | 67.58 |
| 2170 XXX 13XX | Yatay Üçlü Çerçeve | 10 | 110.61 |
| 2170 XXX 14XX | Yatay Dörtlü Çerçeve | 10 | 151.46 |
| 2170 XXX 15XX | Yatay Beşli Çerçeve | 10 | 186.64 |
| 2170 XXX 22XX | Dikey İkili Çerçeve | 10 | 67.58 |
| 2170 XXX 23XX | Dikey Üçlü Çerçeve | 10 | 110.61 |
| 2170 XXX 24XX | Dikey Dörtlü Çerçeve | 10 | 151.46 |
| 2170 XXX 25XX | Dikey Beşli Çerçeve | 10 | 186.64 |

Elitra Chrome

► KROM / PASLANMAZ ÇELİK / ALTIN

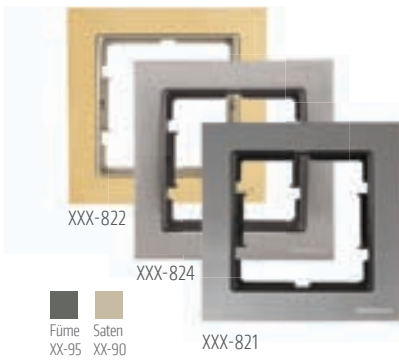

| Kod | Ürün Tanımı | Kutu Adedi | Krom Pas. Çelik Fiyat | Altın Fiyat |
|---------------|----------------------|------------|-----------------------|-------------|
| 2170 XXX 11XX | Tekli Çerçeve | 10 | 36.49 | 43.58 |
| 2170 XXX 12XX | Yatay İkili Çerçeve | 10 | 54.07 | 73.87 |
| 2170 XXX 13XX | Yatay Üçlü Çerçeve | 10 | 87.36 | 107.44 |
| 2170 XXX 14XX | Yatay Dörtlü Çerçeve | 10 | 113.72 | 135.48 |
| 2170 XXX 15XX | Yatay Beşli Çerçeve | 10 | 225.93 | 282.03 |
| 2170 XXX 16XX | Yatay Altılı Çerçeve | 10 | 423.85 | 431.04 |
| 2170 XXX 22XX | Dikey İkili Çerçeve | 10 | 54.07 | 73.87 |
| 2170 XXX 23XX | Dikey Üçlü Çerçeve | 10 | 87.36 | 107.44 |
| 2170 XXX 24XX | Dikey Dörtlü Çerçeve | 10 | 113.72 | 135.48 |
| 2170 XXX 25XX | Dikey Beşli Çerçeve | 10 | 225.93 | 282.03 |
| 2170 XXX 26XX | Dikey Altılı Çerçeve | 10 | 423.85 | 431.04 |



Elitra Chrome

► GÜMÜŞ - PARLAK FÜME

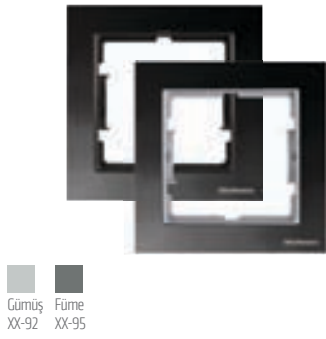

| Kod | Ürün Tanımı | Kutu Adedi | Fiyat |
|---------------|----------------------|------------|--------|
| 2170 825 11XX | Tekli Çerçeve | 10 | 38.87 |
| 2170 825 12XX | İkili Çerçeve | 10 | 66.12 |
| 2170 825 13XX | Üçlü Çerçeve | 10 | 104.44 |
| 2170 825 14XX | Dörtlü Çerçeve | 10 | 120.99 |
| 2170 825 15XX | Beşli Çerçeve | 10 | 247.22 |
| 2170 825 16XX | Altılı Çerçeve | 10 | 339.68 |
| 2170 825 22XX | Dikey İkili Çerçeve | 10 | 66.12 |
| 2170 825 23XX | Üçlü Dikey Çerçeve | 10 | 104.44 |
| 2170 825 24XX | Dörtlü Dikey Çerçeve | 10 | 120.99 |
| 2170 825 25XX | Beşli Dikey Çerçeve | 10 | 247.22 |
| 2170 825 26XX | Altılı Dikey Çerçeve | 10 | 339.68 |

► MAT ALÜMİNYUM - MAT SATEN

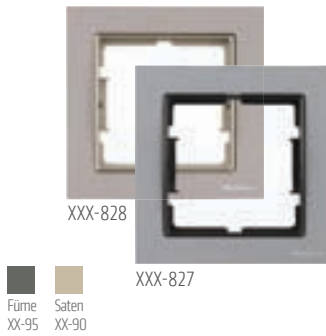

| Kod | Ürün Tanımı | Kutu Adedi | Fiyat |
|---------------|----------------------|------------|--------|
| 2170 XXX 11XX | Tekli Çerçeve | 10 | 28.51 |
| 2170 XXX 12XX | Yatay İkili Çerçeve | 10 | 47.53 |
| 2170 XXX 13XX | Yatay Üçlü Çerçeve | 10 | 76.28 |
| 2170 XXX 14XX | Yatay Dörtlü Çerçeve | 10 | 87.00 |
| 2170 XXX 15XX | Yatay Beşli Çerçeve | 10 | 204.88 |
| 2170 XXX 16XX | Yatay Altılı Çerçeve | 10 | 313.09 |
| 2170 XXX 22XX | Dikey İkili Çerçeve | 10 | 47.53 |
| 2170 XXX 23XX | Dikey Üçlü Çerçeve | 10 | 76.28 |
| 2170 XXX 24XX | Dikey Dörtlü Çerçeve | 10 | 87.00 |
| 2170 XXX 25XX | Dikey Beşli Çerçeve | 10 | 204.88 |
| 2170 XXX 26XX | Dikey Altılı Çerçeve | 10 | 313.09 |

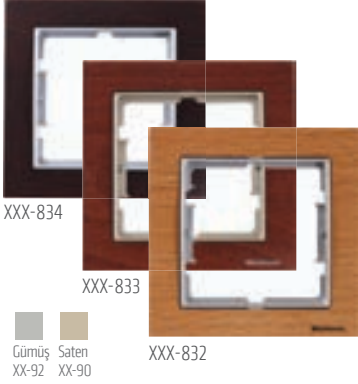

Elitra | Plus

Elitra Wood

► KAYIN / KIRAZ / VENGE

| Kod | Ürün Tanımı | Kutu Adedi | Fiyat |
|---------------|----------------------|------------|--------|
| 2170 XXX 11XX | Tekli Çerçeve | 10 | 46.75 |
| 2170 XXX 12XX | Yatay İkili Çerçeve | 10 | 64.22 |
| 2170 XXX 13XX | Yatay Üçlü Çerçeve | 10 | 96.61 |
| 2170 XXX 14XX | Yatay Dörtlü Çerçeve | 10 | 128.16 |
| 2170 XXX 15XX | Yatay Beşli Çerçeve | 10 | 158.92 |
| 2170 XXX 22XX | Dikey İkili Çerçeve | 10 | 64.22 |
| 2170 XXX 23XX | Dikey Üçlü Çerçeve | 10 | 96.61 |
| 2170 XXX 24XX | Dikey Dörtlü Çerçeve | 10 | 128.16 |
| 2170 XXX 25XX | Dikey Beşli Çerçeve | 10 | 158.92 |

Elitra Marble

► BLACK QUARTZ / SAND STONE



| Kod | Ürün Tanımı | Kutu Adedi | Fiyat |
|---------------|----------------------|------------|--------|
| 2170 XXX 11XX | Tekli Çerçeve | 10 | 60.18 |
| 2170 XXX 12XX | Yatay İkili Çerçeve | 10 | 81.56 |
| 2170 XXX 13XX | Yatay Üçlü Çerçeve | 10 | 119.59 |
| 2170 XXX 14XX | Yatay Dörtlü Çerçeve | 10 | 148.01 |
| 2170 XXX 15XX | Yatay Beşli Çerçeve | 10 | 183.53 |
| 2170 XXX 22XX | Dikey İkili Çerçeve | 10 | 81.56 |
| 2170 XXX 23XX | Dikey Üçlü Çerçeve | 10 | 119.59 |
| 2170 XXX 24XX | Dikey Dörtlü Çerçeve | 10 | 148.01 |
| 2170 XXX 25XX | Dikey Beşli Çerçeve | 10 | 183.53 |

Elitra Ale

► NATURAL / SATEN / MAT FÜME

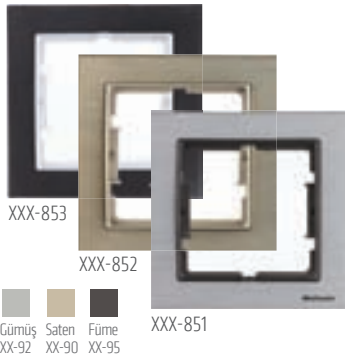

| Kod | Ürün Tanımı | Kutu Adedi | Fiyat |
|---------------|----------------------|------------|--------|
| 2170 XXX 11XX | Tekli Çerçeve | 10 | 32.02 |
| 2170 XXX 12XX | İkili Çerçeve | 10 | 59.46 |
| 2170 XXX 13XX | Üçlü Çerçeve | 10 | 86.91 |
| 2170 XXX 14XX | Dörtlü Çerçeve | 10 | 115.04 |
| 2170 XXX 15XX | Beşli Çerçeve | 10 | 142.67 |
| 2170 XXX 16XX | Altılı Çerçeve | 10 | 301.51 |
| 2170 XXX 22XX | Dikey İkili Çerçeve | 10 | 59.46 |
| 2170 XXX 23XX | Üçlü Dikey Çerçeve | 10 | 86.91 |
| 2170 XXX 24XX | Dörtlü Dikey Çerçeve | 10 | 115.04 |
| 2170 XXX 25XX | Beşli Dikey Çerçeve | 10 | 142.67 |
| 2170 XXX 26XX | Altılı Dikey Çerçeve | 10 | 301.51 |



Beyaz XX-01
 Saten XX-90
 Gümüş XX-92
 Füme XX-95



Elitra Plus SERİSİ

Mekanizma + Tuş Ürün Listesi

BEYAZ-01 / SATEN-90 / GÜMÜŞ-92 / FÜME-95

| Kod | Ürün Tanıtımı | Kutu Adedi | Fiyat |
|----------------|---|------------|-------|
| 2270 001 01XX | Mek+Tuş Anahtar | 10 | 10.81 |
| 2270 002 01XX | Mek+Tuş Komütatör | 10 | 11.63 |
| 2270 003 01XX | Mek+Tuş Vavien (iki Yollu Anahtar) | 10 | 12.57 |
| 2270 004 02XX | Mek+Tuş Komütatör Vavien | 10 | 15.98 |
| 2270 005 01XX | Mek+Tuş Çift Kutuplu Anahtar | 10 | 15.77 |
| 2270 006 01XX | Mek+Tuş Jaluzi Anahtarı-Yaylı | 10 | 16.85 |
| 2270 007 01XX | Mek+Tuş Light (Çağırma) | 10 | 10.52 |
| 2270 007 01XXZ | Mek+Tuş Zil Anahtarı | 10 | 10.52 |
| 2270 007 01XXK | Mek+Tuş Kapı Otomatığı Anahtarı | 10 | 10.52 |
| 2270 008 01XX | Mek+Tuş Deviator (Ara Vavien) | 10 | 16.14 |
| 2270 009 02XX | Mek+Tuş Üçlü Anahtar | 10 | 16.60 |
| 2270 011 02XX | Mek+Tuş Şofben Anahtarı | 10 | 11.47 |
| 2270 015 01XX | Mek+Tuş Işıklı Anahtar (220V) | 10 | 13.17 |
| 2270 016 01XX | Mek+Tuş Işıklı Vavien (220V) | 10 | 15.17 |
| 2270 017 01XX | Mek+Tuş Işıklı Çağırma (220V) | 10 | 13.42 |
| 2270 018 01XX | Mek+Tuş Işıklı Etiketli Anahtar (220V) | 10 | 13.86 |
| 2270 019 01XX | Mek+Tuş Işıklı Etiketli Çağırma (220V) | 10 | 13.86 |
| 2270 022 01XX | Mek+Tuş Işıklı Zil Etiketli Çağırma (12V) | 10 | 13.86 |
| 2270 026 01XX | Mek+Tuş Işıklı Komütatör | 10 | 19.19 |

Dimmer Grubu

| | | | |
|---------------|-----------------------------|---|-------|
| 2270 040 02XX | Mek+Tuş Işıklı Dimmer 600W | 8 | 56.00 |
| 2270 044 02XX | Mek+Tuş Işıklı Dimmer 1000W | 8 | 70.50 |

Elektronik Grubu

| | | | |
|---------------|--|----|--------|
| 2270 050 01XX | Mek+Tuş Energy Saver Gecikmesiz Işıklı | 8 | 85.77 |
| 2270 052 01XX | Mek+Tuş Energy Saver Gecikmeli | 8 | 79.72 |
| 2270 070 02XX | Mek+Tuş Müzik Yayın Anahtarı | 8 | 68.70 |
| 2270 080 01XX | Mek+Tuş Hoparlör Prizi | 10 | 30.18 |
| 2270 085 02XX | Mek+Tuş Uyan Zili | 10 | 53.70 |
| 2270 095 02XX | Mek+Tuş Hareket Sensörü | 10 | 105.93 |

Priz Grubu

| | | | |
|---------------|---|----|-------|
| 2270 100 02XX | Mek+Tuş Topraklı Priz | 10 | 10.73 |
| 2270 101 02XX | Mek+Tuş Topraksız Priz | 10 | 9.50 |
| 2270 105 02XX | Mek+Tuş Topraklı Priz (Çocuk Korumalı) | 10 | 14.50 |
| 2270 106 02XX | Mek+Tuş Topraksız Priz (Çocuk Korumalı) | 10 | 12.70 |
| 2270 110 02XX | Mek+Tuş Kapaklı Topraklı Priz | 10 | 11.80 |
| 2270 111 02XX | Mek+Tuş Kapaklı Topraklı Priz (Çocuk Korumalı) | 10 | 16.74 |
| 2270 115 02XX | Mek+Tuş Ups (Fransız) Prizi | 10 | 15.32 |
| 2270 116 02XX | Mek+Tuş Ups (Fransız) Prizi (Çocuk Korumalı) | 10 | 16.85 |
| 2270 117 02XX | Mek+Tuş Ups Kapaklı (Fransız) Priz | 10 | 18.00 |
| 2270 118 02XX | Mek+Tuş Ups Kapaklı (Fransız) Priz (Çocuk Korumalı) | 10 | 20.00 |
| 2270 121 01XX | Mek+Tuş Kör Kapak | 10 | 13.33 |

İletişim Grubu

| | | | |
|---------------|--|----|-------|
| 2270 055 01XX | Mek+Tuş Data Prizi 1*Usb | 10 | 27.21 |
| 2270 056 01XX | Mek+Tuş Data Prizi 2*Usb | 10 | 46.35 |
| 2270 057 01XX | Mek+Tuş Data Prizi 1*Hdmi | 10 | 34.22 |
| 2270 058 01XX | Mek+Tuş Data Prizi 2*Hdmi | 10 | 60.00 |
| 2270 059 01XX | Mek+Tuş Data Prizi 1*Usb/1*Hdmi | 10 | 52.67 |
| 2270 125 01XX | Mek+Tuş Telefon Prizi 1*Rj12 Cat3 | 10 | 13.00 |
| 2270 126 01XX | Mek+Tuş Telefon Prizi 2*Rj12 Cat3 | 10 | 19.23 |
| 2270 128 01XX | Mek+Tuş Etiketli Tlf+Data Priz (Kon.süz) | 10 | 9.05 |
| 2270 135 01XX | Mek+Tuş Data Prizi 1*Rj45 (Kon.süz) | 10 | 8.62 |
| 2270 136 01XX | Mek+Tuş Data Prizi 1*Rj45 (Cat5e) | 10 | 27.40 |
| 2270 137 01XX | Mek+Tuş Data Prizi 2*Rj45 (Kon.süz) | 10 | 8.62 |
| 2270 138 01XX | Mek+Tuş Data Prizi 2*Rj45 (Cat5e) | 10 | 43.02 |
| 2270 139 01XX | Mek+Tuş Tlf+Data Priz (Rj12 Cat3+Cat5e) | 10 | 37.70 |
| 2270 140 01XX | Mek+Tuş Data Prizi 1*Rj45 (Cat6) | 10 | 37.27 |
| 2270 141 01XX | Mek+Tuş Data Prizi 2*Rj45 (Cat6) | 10 | 57.57 |

TV / Sat Grubu

| | | | |
|---------------|--------------------------------|----|-------|
| 2270 156 02XX | Mek+Tuş Tv-Sat Prizi (Geçişli) | 10 | 53.14 |
| 2270 157 02XX | Mek+Tuş Tv-Sat Prizi (Sonlu) | 10 | 53.14 |
| 2270 166 01XX | Mek+Tuş Sat Prizi (Geçişli) | 10 | 31.93 |
| 2270 167 01XX | Mek+Tuş Sat Prizi (Sonlu) | 10 | 31.93 |
| 2270 170 01XX | Mek+Tuş Tv Prizi (Geçişli) | 10 | 16.45 |
| 2270 171 01XX | Mek+Tuş Tv Prizi (Sonlu) | 10 | 16.45 |
| 2270 172 01XX | Mek+Tuş Tv Prizi F Dişi | 10 | 8.80 |



Candela





PRİZ
LIVA
OLIMPIA
NEMLİYER
BRON
DARIA
CANDELA
PLUS
ELITRA
RITA



Beyaz
01
Krem
02

| Kod | Ürün Tanımı | Kutu Adedi | Koli Adedi | Fiyat |
|----------------|--|------------|------------|-------|
| 2100 001 01XX | Mek+Tuş Anahtar | 12 | 120 | 5.20 |
| 2100 002 01XX | Mek+Tuş Komütatör | 12 | 120 | 7.06 |
| 2100 003 01XX | Mek+Tuş Vavien (İki Yollu Anahtar) | 12 | 120 | 7.27 |
| 2100 004 02XX | Mek+Tuş Komütatör Vavien | 12 | 120 | 11.52 |
| 2100 005 01XX | Mek+Tuş Çift Kutuplu Anahtar | 12 | 120 | 7.68 |
| 2100 006 01XX | Mek+Tuş Jaluzi Anahtar-Yaylı | 12 | 120 | 10.97 |
| 2100 007 01XX | Mek+Tuş Light (Çağırma) | 12 | 120 | 7.00 |
| 2100 007 01XXZ | Mek+Tuş Zil Anahtar | 12 | 120 | 7.00 |
| 2100 007 01XXK | Mek+Tuş Kapı Otomatığı Anahtar | 12 | 120 | 7.00 |
| 2100 009 02XX | Mek+Tuş Deviyatör (Ara Vavien) | 12 | 120 | 10.64 |
| 2100 009 02XX | Mek+Tuş Üçlü Anahtar | 12 | 120 | 10.29 |
| 2100 011 02XX | Mek+Tuş Şofben Anahtar | 12 | 120 | 7.43 |
| 2100 015 01XX | Mek+Tuş Işıklı Anahtar (220V) | 12 | 120 | 9.88 |
| 2100 016 01XX | Mek+Tuş Işıklı Vavien (220V) | 12 | 120 | 11.66 |
| 2100 017 01XX | Mek+Tuş Işıklı Çağırma(220V) | 12 | 120 | 10.15 |
| 2100 018 01XX | Mek+Tuş Işıklı Etiketli Anahtar (220V) | 12 | 120 | 10.29 |
| 2100 019 01XX | Mek+Tuş Işıklı Etiketli Çağırma (220V) | 12 | 120 | 10.43 |
| 2100 022 01XX | Mek+Tuş Işıklı Zil Etiketli Çağırma(12V) | 12 | 120 | 9.96 |
| 2100 026 01XX | Mek+Tuş Işıklı Komütatör | 12 | 120 | 12.89 |

Dimmer Grubu

| | | | | |
|---------------|-----------------------------|---|----|-------|
| 2100 040 02XX | Mek+Tuş Işıklı Dimmer 600W | 8 | 80 | 45.90 |
| 2100 044 02XX | Mek+Tuş Işıklı Dimmer 1000W | 8 | 80 | 57.61 |

Elektronik Grubu

| | | | | |
|---------------|--|----|-----|-------|
| 2100 050 01XX | Mek+Tuş Energy Saver Gecikmesiz Işıklı | 8 | 80 | 65.84 |
| 2100 052 01XX | Mek+Tuş Energy Saver Gecikmeli Işıklı | 8 | 80 | 65.84 |
| 2100 070 02XX | Mek+Tuş Müzik Yayın Anahtar | 8 | 80 | 50.75 |
| 2100 080 01XX | Mek+Tuş Hoparlör Prizi | 12 | 120 | 19.75 |
| 2100 085 02XX | Mek+Tuş Uyan Zili | 12 | 120 | 39.78 |
| 2100 095 02XX | Mek+Tuş Hareket Sensörü | 12 | 120 | 76.82 |

Priz Grubu

| | | | | |
|---------------|---|----|-----|-------|
| 2100 100 02XX | Mek+Tuş Topraklı Priz | 12 | 120 | 6.04 |
| 2100 101 02XX | Mek+Tuş Topraksız Priz | 12 | 120 | 5.41 |
| 2100 105 02XX | Mek+Tuş Topraklı Priz (Çocuk Korumalı) | 12 | 120 | 7.96 |
| 2100 106 02XX | Mek+Tuş Topraksız Priz (Çocuk Korumalı) | 12 | 120 | 7.00 |
| 2100 110 02XX | Mek+Tuş Kapaklı Topraklı Priz | 12 | 120 | 7.41 |
| 2100 111 02XX | Mek+Tuş Kapaklı Topraklı Priz (Çoc.Kor.) | 12 | 120 | 9.33 |
| 2100 115 02XX | Mek+Tuş Ups (Fransız) Prizi | 12 | 120 | 7.41 |
| 2100 116 02XX | Mek+Tuş Ups (Fransız) Prizi (Çocuk Korumalı) | 12 | 120 | 8.83 |
| 2100 117 02XX | Mek+Tuş Ups Kapaklı (Fransız) Priz | 12 | 120 | 8.99 |
| 2100 118 02XX | Mek+Tuş Ups Kapaklı (Fransız) Priz (Çocuk Kor.) | 12 | 120 | 9.19 |
| 2100 121 01XX | Mek+Tuş Kör Kapak | 12 | 120 | 4.94 |
| 2100 200 02XX | Mek+Tuş İkili Topraklı Priz Porselen | 5 | 50 | 10.11 |
| 2100 201 02XX | Mek+Tuş İkili Topraksız Priz Porselen | 5 | 50 | 8.39 |
| 2100 202 02XX | Mek+Tuş İkili Topraklı Priz | 5 | 50 | 9.01 |
| 2100 203 02XX | Mek+Tuş İkili Topraksız Priz | 5 | 50 | 7.20 |
| 2100 215 02XX | Mek+Tuş İkili UPS (Fransız) Priz | 5 | 50 | 10.65 |

İletişim Grubu

| | | | | |
|---------------|--|----|-----|-------|
| 2100 055 01XX | Mek+Tuş Data Prizi 1*Usb | 12 | 120 | 22.77 |
| 2100 056 01XX | Mek+Tuş Data Prizi 2*Usb | 12 | 120 | 39.68 |
| 2125 057 01XX | Mek+Tuş Data Prizi 1*Hdmi | 12 | 120 | 28.53 |
| 2100 058 01XX | Mek+Tuş Data Prizi 2*Hdmi | 12 | 120 | 50.92 |
| 2100 059 01XX | Mek+Tuş Data Prizi 1*Usb/1*Hdmi | 12 | 120 | 44.56 |
| 2100 125 01XX | Mek+Tuş Telefon Prizi 1*Rj12 | 12 | 120 | 9.19 |
| 2100 126 01XX | Mek+Tuş Telefon Prizi 2*Rj12 | 12 | 120 | 12.76 |
| 2100 128 01XX | Mek+Tuş Etiketli Tlf+Data Priz (Kon.süz) | 12 | 120 | 5.49 |
| 2100 135 01XX | Mek+Tuş Data Prizi 1*Rj45 (Kon.süz) | 12 | 120 | 5.21 |
| 2100 136 01XX | Mek+Tuş Data Prizi 1*Rj45 (Cat5e) | 12 | 120 | 15.09 |
| 2100 137 01XX | Mek+Tuş Data Prizi 2*Rj45 (Kon.süz) | 12 | 120 | 5.76 |
| 2100 138 01XX | Mek+Tuş Data Prizi 2*Rj45 (Cat5e) | 12 | 120 | 24.69 |
| 2100 139 01XX | Mek+Tuş Tlf+Data Priz (Rj12Cat3+Cat5e) | 12 | 120 | 20.03 |
| 2100 140 01XX | Mek+Tuş Data Prizi 1*Rj45 (Cat6) | 12 | 120 | 17.50 |
| 2100 141 01XX | Mek+Tuş Data Prizi 2*Rj45 (Cat6) | 12 | 120 | 31.55 |

TV / Sat Grubu

| | | | | |
|---------------|-------------------------------|----|-----|-------|
| 2100 156 02XX | Mek+Tuş Tv-Sat Prizi (Geçşli) | 12 | 120 | 36.89 |
| 2100 157 02XX | Mek+Tuş Tv-Sat Prizi (Sonlu) | 12 | 120 | 36.89 |
| 2100 166 01XX | Mek+Tuş Sat Prizi (Geçşli) | 12 | 120 | 19.20 |
| 2100 167 01XX | Mek+Tuş Sat Prizi (Sonlu) | 12 | 120 | 19.20 |
| 2100 170 01XX | Mek+Tuş Tv Prizi (Geçşli) | 12 | 120 | 11.61 |
| 2100 171 01XX | Mek+Tuş Tv Prizi (Sonlu) | 12 | 120 | 11.61 |
| 2100 172 01XX | Mek+Tuş Tv Prizi F Dişi | 12 | 120 | 7.27 |

İngiliz Tip

| | | | | |
|---------------|-----------------------------------|----|-----|-------|
| 2190 500 0201 | İngiliz Tipi Anahtarlı Priz Beyaz | 12 | 120 | 23.30 |
|---------------|-----------------------------------|----|-----|-------|

Çerçeveler

| | | | | |
|---------------|------------------------------|----|-----|------|
| 2125 800 11XX | Candela Tekli Çerçeve | 20 | 400 | 1.03 |
| 2125 800 12XX | Candela İkili Yatay Çerçeve | 10 | 200 | 3.20 |
| 2125 800 13XX | Candela Üçlü Yatay Çerçeve | 10 | 50 | 4.12 |
| 2125 800 14XX | Candela Dörtlü Yatay Çerçeve | 10 | 50 | 5.08 |
| 2125 800 15XX | Candela Beşli Yatay Çerçeve | 10 | 50 | 6.45 |
| 2125 800 16XX | Candela Altılı Yatay Çerçeve | 10 | 50 | 8.50 |
| 2125 800 22XX | Candela İkili Dikey Çerçeve | 10 | 50 | 3.20 |
| 2125 800 23XX | Candela Üçlü Dikey Çerçeve | 10 | 50 | 4.12 |
| 2125 800 24XX | Candela Dörtlü Dikey Çerçeve | 10 | 50 | 5.08 |
| 2125 800 25XX | Candela Beşli Dikey Çerçeve | 10 | 50 | 6.45 |
| 2125 800 26XX | Candela Altılı Dikey Çerçeve | 10 | 50 | 8.50 |
| 2100 820 1201 | Candela İkili Priz Çerçeve | 10 | 60 | 1.45 |
| 2125 000 11XX | Sıva Üstü Kasa | 12 | 60 | 2.70 |

| Kod | Ürün Tanımı | Kutu Adedi | Koli Adedi | Fiyat |
|----------------|---|------------|------------|-------|
| 2100 001 01XX | Mek+Tuş Anahtar | 12 | 120 | 7.96 |
| 2100 002 01XX | Mek+Tuş Komütatör | 12 | 120 | 9.47 |
| 2100 003 01XX | Mek+Tuş Vavien (iki Yollu Anahtar) | 12 | 120 | 9.38 |
| 2100 004 02XX | Mek+Tuş Komütatör Vavien | 12 | 120 | 13.84 |
| 2100 005 01XX | Mek+Tuş Çift Kutuplu Anahtar | 12 | 120 | 9.47 |
| 2100 006 01XX | Mek+Tuş Jaluzi Anahtar-Yaylı | 12 | 120 | 14.18 |
| 2100 007 01XX | Mek+Tuş Light (Çağırma) | 12 | 120 | 8.81 |
| 2100 007 01XXZ | Mek+Tuş Zil Anahtar | 12 | 120 | 8.81 |
| 2100 007 01XXK | Mek+Tuş Kapı Otomatığı Anahtar | 12 | 120 | 8.81 |
| 2100 009 02XX | Mek+Tuş Deviator (Ara Vavien) | 12 | 120 | 13.59 |
| 2100 009 02XX | Mek+Tuş Üçlü Anahtar | 12 | 120 | 13.97 |
| 2100 011 02XX | Mek+Tuş Şofben Anahtar | 12 | 120 | 9.66 |
| 2100 015 01XX | Mek+Tuş Işıklı Anahtar (220V) | 12 | 120 | 12.55 |
| 2100 016 01XX | Mek+Tuş Işıklı Vavien (220V) | 12 | 120 | 13.44 |
| 2100 017 01XX | Mek+Tuş Işıklı Çağırma (220V) | 12 | 120 | 13.74 |
| 2100 018 01XX | Mek+Tuş Işıklı Etiketli Anahtar (220V) | 12 | 120 | 11.80 |
| 2100 019 01XX | Mek+Tuş Işıklı Etiketli Çağırma (220V) | 12 | 120 | 11.80 |
| 2100 022 01XX | Mek+Tuş Işıklı Zil Etiketli Çağırma (12V) | 12 | 120 | 11.80 |
| 2100 026 01XX | Mek+Tuş Işıklı Komütatör | 12 | 120 | 15.53 |

Dimmer Grubu

| | | | | |
|---------------|-----------------------------|---|----|-------|
| 2100 040 02XX | Mek+Tuş Işıklı Dimmer 600W | 8 | 80 | 47.15 |
| 2100 044 02XX | Mek+Tuş Işıklı Dimmer 1000W | 8 | 80 | 59.37 |

Elektronik Grubu

| | | | | |
|---------------|--|----|-----|-------|
| 2100 050 01XX | Mek+Tuş Energy Saver Gecikmesiz Işıklı | 8 | 80 | 67.98 |
| 2100 052 01XX | Mek+Tuş Energy Saver Gecikmeli | 8 | 80 | 67.98 |
| 2100 070 02XX | Mek+Tuş Müzik Yayın Anahtar | 8 | 80 | 57.79 |
| 2100 080 01XX | Mek+Tuş Hoparlör Prizi | 12 | 120 | 25.41 |
| 2100 085 02XX | Mek+Tuş Uyan Zili | 12 | 120 | 45.19 |
| 2100 095 02XX | Mek+Tuş Hareket Sensörü | 12 | 120 | 89.16 |

Priz Grubu

| | | | | |
|---------------|---|----|-----|-------|
| 2100 100 02XX | Mek+Tuş Topraklı Priz | 12 | 120 | 9.02 |
| 2100 101 02XX | Mek+Tuş Topraksız Priz | 12 | 120 | 8.01 |
| 2100 105 02XX | Mek+Tuş Topraklı Priz (Çocuk Korumalı) | 12 | 120 | 12.21 |
| 2100 106 02XX | Mek+Tuş Topraksız Priz (Çocuk Korumalı) | 12 | 120 | 10.69 |
| 2100 110 02XX | Mek+Tuş Kapaklı Topraklı Priz | 12 | 120 | 9.93 |
| 2100 111 02XX | Mek+Tuş Kapaklı Topraklı Priz (Çoc.Kor.) | 12 | 120 | 14.09 |
| 2100 115 02XX | Mek+Tuş Ups (Fransız) Prizi | 12 | 120 | 12.89 |
| 2100 116 02XX | Mek+Tuş Ups (Fransız) Prizi (Çocuk Korumalı) | 12 | 120 | 14.18 |
| 2100 117 02XX | Mek+Tuş Ups Kapaklı (Fransız) Priz | 12 | 120 | 15.16 |
| 2100 118 02XX | Mek+Tuş Ups Kapaklı (Fransız) Priz (Çocuk Kor.) | 12 | 120 | 16.88 |
| 2100 121 01XX | Mek+Tuş Kör Kapak | 12 | 120 | 11.23 |
| 2100 200 02XX | Mek+Tuş İkili Topraklı Priz Porselen | 5 | 50 | 13.27 |
| 2100 201 02XX | Mek+Tuş İkili Topraksız Priz Porselen | 5 | 50 | 12.35 |
| 2100 202 02XX | Mek+Tuş İkili Topraklı Priz | 5 | 50 | 11.93 |
| 2100 203 02XX | Mek+Tuş İkili Topraksız Priz | 5 | 50 | 9.60 |
| 2100 215 02XX | Mek+Tuş İkili UPS (Fransız) Priz | 5 | 50 | 13.72 |

İletişim Grubu

| | | | | |
|---------------|--|----|-----|-------|
| 2100 055 01XX | Mek+Tuş Data Prizi 1*Usb | 12 | 120 | 22.91 |
| 2100 056 01XX | Mek+Tuş Data Prizi 2*Usb | 12 | 120 | 39.02 |
| 2125 057 01XX | Mek+Tuş Data Prizi 1*Hdmi | 12 | 120 | 28.81 |
| 2100 058 01XX | Mek+Tuş Data Prizi 2*Hdmi | 12 | 120 | 50.50 |
| 2100 059 01XX | Mek+Tuş Data Prizi 1*Usb/1*Hdmi | 12 | 120 | 44.34 |
| 2100 125 01XX | Mek+Tuş Telefon Prizi 1*Rj12 (Cat3) | 12 | 120 | 10.97 |
| 2100 126 01XX | Mek+Tuş Telefon Prizi 2*Rj12 (Cat3) | 12 | 120 | 16.19 |
| 2100 128 01XX | Mek+Tuş Etiketli Tlf+Data Priz (Kon.süz) | 12 | 120 | 7.62 |
| 2100 135 01XX | Mek+Tuş Data Prizi 1*Rj45 (Kon.süz) | 12 | 120 | 7.26 |
| 2100 136 01XX | Mek+Tuş Data Prizi 1*Rj45 (Cat5e) | 12 | 120 | 23.05 |
| 2100 137 01XX | Mek+Tuş Data Prizi 2*Rj45 (Kon.süz) | 12 | 120 | 7.27 |
| 2100 138 01XX | Mek+Tuş Data Prizi 2*Rj45 (Cat5e) | 12 | 120 | 36.21 |
| 2100 139 01XX | Mek+Tuş Tlf+Data Priz (Rj12,Cat3+Cat5e) | 12 | 120 | 31.72 |
| 2100 140 01XX | Mek+Tuş Data Prizi 1*Rj45 (Cat6) | 12 | 120 | 23.05 |
| 2100 141 01XX | Mek+Tuş Data Prizi 2*Rj45 (Cat6) | 12 | 120 | 36.21 |

TV / Sat Grubu

| | | | | |
|---------------|--------------------------------|----|-----|-------|
| 2100 156 02XX | Mek+Tuş Tv-Sat Prizi (Geçişli) | 12 | 120 | 44.73 |
| 2100 157 02XX | Mek+Tuş Tv-Sat Prizi (Sonlu) | 12 | 120 | 44.73 |
| 2100 166 01XX | Mek+Tuş Sat Prizi (Geçişli) | 12 | 120 | 24.06 |
| 2100 167 01XX | Mek+Tuş Sat Prizi (Sonlu) | 12 | 120 | 24.06 |
| 2100 170 01XX | Mek+Tuş Tv Prizi (Geçişli) | 12 | 120 | 13.61 |
| 2100 171 01XX | Mek+Tuş Tv Prizi (Sonlu) | 12 | 120 | 13.61 |
| 2100 172 01XX | Mek+Tuş Tv Prizi F Dişi | 12 | 120 | 7.41 |

Çerçeveler

| | | | | |
|---------------|------------------------------|----|-----|-------|
| 2125 800 11XX | Candela Tekli Çerçeve | 20 | 400 | 2.15 |
| 2125 800 12XX | Candela İkili Yatay Çerçeve | 10 | 200 | 3.98 |
| 2125 800 13XX | Candela Üçlü Yatay Çerçeve | 10 | 50 | 7.93 |
| 2125 800 14XX | Candela Dörtlü Yatay Çerçeve | 10 | 50 | 9.96 |
| 2125 800 15XX | Candela Beşli Yatay Çerçeve | 10 | 50 | 12.80 |
| 2125 800 16XX | Candela Altılı Yatay Çerçeve | 10 | 50 | 16.85 |
| 2125 800 22XX | Candela İkili Dikey Çerçeve | 10 | 50 | 3.98 |
| 2125 800 23XX | Candela Üçlü Dikey Çerçeve | 10 | 50 | 7.93 |
| 2125 800 24XX | Candela Dörtlü Dikey Çerçeve | 10 | 50 | 9.96 |
| 2125 800 25XX | Candela Beşli Dikey Çerçeve | 10 | 50 | 12.80 |
| 2125 800 26XX | Candela Altılı Dikey Çerçeve | 10 | 50 | 16.85 |
| 2100 820 11XX | İkili Priz Çerçeve | 10 | 60 | 3.57 |
| 2125 000 11XX | Sıva Üstü Kasa | 12 | 60 | 5.42 |



A. Altın 80
Inox 82
Titanyum 83
Füme 95
S. Beyaz 81

ELITRA PLUS
CANDELA
DARIA
RITA
NEMLIYER
OLIMPIA

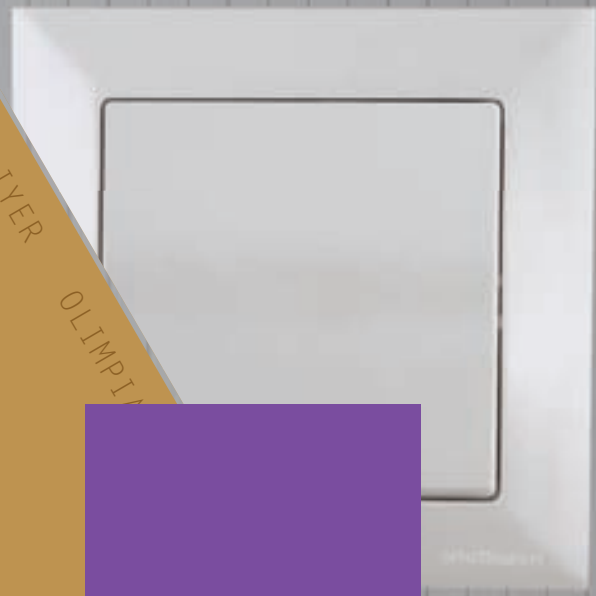

BRON
ELITRA PLUS
CANDELA
RITA
BRON
NEMLIYER
OLIMPIA

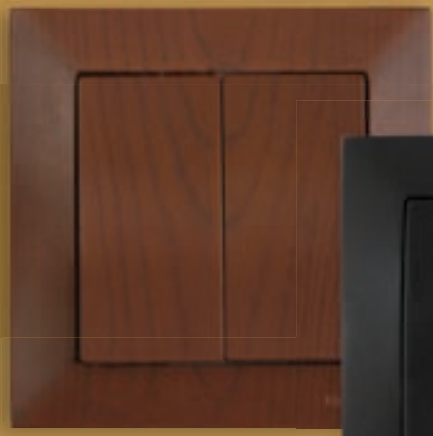



PRİZ
LİVİS
OLİMPIA
NEMLİYER
BRON
DARIA
CANDELA
PLUS
ELİTRA
RİTA



■ Siyah
■ Bordo
60 61

| Kod | Ürün Tanımı | Kutu Adedi | Koli Adedi | Fiyat |
|----------------|---|------------|------------|-------|
| 2100 001 01XX | Mek+Tuş Anahtar | 12 | 120 | 9.12 |
| 2100 002 01XX | Mek+Tuş Komütatör | 12 | 120 | 12.25 |
| 2100 003 01XX | Mek+Tuş Vavien (İki Yollu Anahtar) | 12 | 120 | 11.43 |
| 2100 004 02XX | Mek+Tuş Komütatör Vavien | 12 | 120 | 18.03 |
| 2100 005 01XX | Mek+Tuş Çift Kutuplu Anahtar | 12 | 120 | 14.60 |
| 2100 006 01XX | Mek+Tuş Jaluzi Anahtar-Yaylı | 12 | 120 | 16.68 |
| 2100 007 01XX | Mek+Tuş Light (Çağırma) | 12 | 120 | 11.55 |
| 2100 007 01XXZ | Mek+Tuş Zil Anahtar | 12 | 120 | 11.55 |
| 2100 007 01XXK | Mek+Tuş Kapı Otomatiği Anahtar | 12 | 120 | 11.55 |
| 2100 009 02XX | Mek+Tuş Deviator (Ara Vavien) | 12 | 120 | 14.68 |
| 2100 009 02XX | Mek+Tuş Üçlü Anahtar | 12 | 120 | 16.92 |
| 2100 011 02XX | Mek+Tuş Şofben Anahtar | 12 | 120 | 13.99 |
| 2100 015 01XX | Mek+Tuş Işıklı Anahtar (220V) | 12 | 120 | 13.01 |
| 2100 016 01XX | Mek+Tuş Işıklı Vavien (220V) | 12 | 120 | 14.57 |
| 2100 017 01XX | Mek+Tuş Işıklı Çağırma (220V) | 12 | 120 | 14.04 |
| 2100 018 01XX | Mek+Tuş Işıklı Etiketli Anahtar (220V) | 12 | 120 | 13.17 |
| 2100 019 01XX | Mek+Tuş Işıklı Etiketli Çağırma (220V) | 12 | 120 | 14.51 |
| 2100 022 01XX | Mek+Tuş Işıklı Zil Etiketli Çağırma (12V) | 12 | 120 | 13.94 |
| 2100 026 01XX | Mek+Tuş Işıklı Komütatör | 12 | 120 | 17.25 |

Dimmer Grubu

| | | | | |
|---------------|-----------------------------|---|----|-------|
| 2100 040 02XX | Mek+Tuş Işıklı Dimmer 600W | 8 | 80 | 50.50 |
| 2100 044 02XX | Mek+Tuş Işıklı Dimmer 1000W | 8 | 80 | 64.20 |

Elektronik Grubu

| | | | | |
|---------------|--|----|-----|--------|
| 2100 050 01XX | Mek+Tuş Energy Saver Gecikmesiz Işıklı | 8 | 80 | 101.09 |
| 2100 052 01XX | Mek+Tuş Energy Saver Gecikmeli | 8 | 80 | 93.58 |
| 2100 070 02XX | Mek+Tuş Müzik Yayın Anahtar | 8 | 80 | 62.00 |
| 2100 080 01XX | Mek+Tuş Hoparlör Prizi | 12 | 120 | 28.50 |
| 2100 085 02XX | Mek+Tuş Uyan Zili | 12 | 120 | 49.60 |
| 2100 095 02XX | Mek+Tuş Hareket Sensörü | 12 | 120 | 95.85 |

Priz Grubu

| | | | | |
|---------------|---|----|-----|-------|
| 2100 100 02XX | Mek+Tuş Topraklı Priz | 12 | 120 | 9.80 |
| 2100 101 02XX | Mek+Tuş Topraksız Priz | 12 | 120 | 8.90 |
| 2100 105 02XX | Mek+Tuş Topraklı Priz (Çocuk Korumalı) | 12 | 120 | 15.50 |
| 2100 106 02XX | Mek+Tuş Topraksız Priz (Çocuk Korumalı) | 12 | 120 | 13.20 |
| 2100 110 02XX | Mek+Tuş Kapaklı Topraklı Priz | 12 | 120 | 11.55 |
| 2100 111 02XX | Mek+Tuş Kapaklı Topraklı Priz (Çoc.Kor.) | 12 | 120 | 15.65 |
| 2100 115 02XX | Mek+Tuş Ups (Fransız) Prizi | 12 | 120 | 13.80 |
| 2100 116 02XX | Mek+Tuş Ups (Fransız) Prizi (Çocuk Korumalı) | 12 | 120 | 15.20 |
| 2100 117 02XX | Mek+Tuş Ups Kapaklı (Fransız) Priz | 12 | 120 | 16.35 |
| 2100 118 02XX | Mek+Tuş Ups Kapaklı (Fransız) Priz (Çocuk Kor.) | 12 | 120 | 18.10 |
| 2100 121 01XX | Mek+Tuş Kör Kapak | 12 | 120 | 12.25 |
| 2100 200 02XX | Mek+Tuş İkili Topraklı Priz Porselen | 5 | 50 | 14.65 |
| 2100 201 02XX | Mek+Tuş İkili Topraksız Priz Porselen | 5 | 50 | 13.70 |
| 2100 202 02XX | Mek+Tuş İkili Topraklı Priz | 5 | 50 | 13.00 |
| 2100 203 02XX | Mek+Tuş İkili Topraksız Priz | 5 | 50 | 10.60 |
| 2100 215 02XX | Mek+Tuş İkili UPS (Fransız) Priz | 5 | 50 | 15.00 |

İletişim Grubu

| | | | | |
|---------------|--|----|-----|-------|
| 2100 055 01XX | Mek+Tuş Data Prizi 1*Usb | 12 | 120 | 24.85 |
| 2100 056 01XX | Mek+Tuş Data Prizi 2*Usb | 12 | 120 | 41.90 |
| 2125 057 01XX | Mek+Tuş Data Prizi 1*Hdmi | 12 | 120 | 31.00 |
| 2100 058 01XX | Mek+Tuş Data Prizi 2*Hdmi | 12 | 120 | 54.00 |
| 2100 059 01XX | Mek+Tuş Data Prizi 1*Usb/1*Hdmi | 12 | 120 | 47.50 |
| 2100 125 01XX | Mek+Tuş Telefon Prizi 1*Rj12 Cat3 | 12 | 120 | 13.27 |
| 2100 126 01XX | Mek+Tuş Telefon Prizi 2*Rj12 Cat3 | 12 | 120 | 17.95 |
| 2100 128 01XX | Mek+Tuş Etiketli Tlf+Data Priz (Kon.süz) | 12 | 120 | 10.10 |
| 2100 135 01XX | Mek+Tuş Data Prizi 1*Rj45 (Kon.süz) | 12 | 120 | 10.10 |
| 2100 136 01XX | Mek+Tuş Data Prizi 1*Rj45 (Cat5e) | 12 | 120 | 25.55 |
| 2100 137 01XX | Mek+Tuş Data Prizi 2*Rj45 (Kon.süz) | 12 | 120 | 10.10 |
| 2100 138 01XX | Mek+Tuş Data Prizi 2*Rj45 (Cat5e) | 12 | 120 | 38.90 |
| 2100 139 01XX | Mek+Tuş Tlf+Data Priz (Rj12+Cat5e) | 12 | 120 | 34.20 |
| 2100 140 01XX | Mek+Tuş Data Prizi 1*Rj45 (Cat6) | 12 | 120 | 36.80 |
| 2100 141 01XX | Mek+Tuş Data Prizi 2*Rj45 (Cat6) | 12 | 120 | 42.30 |

TV / Sat Grubu

| | | | | |
|---------------|--------------------------------|----|-----|-------|
| 2100 156 02XX | Mek+Tuş Tv-Sat Prizi (Geçişli) | 12 | 120 | 47.80 |
| 2100 157 02XX | Mek+Tuş Tv-Sat Prizi (Sonlu) | 12 | 120 | 47.80 |
| 2100 166 01XX | Mek+Tuş Sat Prizi (Geçişli) | 12 | 120 | 34.05 |
| 2100 167 01XX | Mek+Tuş Sat Prizi (Sonlu) | 12 | 120 | 34.05 |
| 2100 170 01XX | Mek+Tuş Tv Prizi (Geçişli) | 12 | 120 | 15.83 |
| 2100 171 01XX | Mek+Tuş Tv Prizi (Sonlu) | 12 | 120 | 15.83 |
| 2100 172 01XX | Mek+Tuş Tv Prizi F Dişi | 12 | 120 | 9.95 |

Çerçeveler

| | | | | |
|---------------|------------------------------|----|-----|-------|
| 2125 800 11XX | Candela Tekli Çerçeve | 20 | 400 | 6.49 |
| 2125 800 12XX | Candela İkili Yatay Çerçeve | 10 | 200 | 9.16 |
| 2125 800 13XX | Candela Üçlü Yatay Çerçeve | 10 | 50 | 10.73 |
| 2125 800 14XX | Candela Dörtlü Yatay Çerçeve | 10 | 50 | 12.39 |
| 2125 800 15XX | Candela Beşli Yatay Çerçeve | 10 | 50 | 15.27 |
| 2125 800 16XX | Candela Altılı Yatay Çerçeve | 10 | 50 | 18.03 |
| 2125 800 22XX | Candela İkili Dikey Çerçeve | 10 | 50 | 9.16 |
| 2125 800 23XX | Candela Üçlü Dikey Çerçeve | 10 | 50 | 10.73 |
| 2125 800 24XX | Candela Dörtlü Dikey Çerçeve | 10 | 50 | 12.39 |
| 2125 800 25XX | Candela Beşli Dikey Çerçeve | 10 | 50 | 15.27 |
| 2125 800 26XX | Candela Altılı Dikey Çerçeve | 10 | 50 | 18.03 |
| 2125 820 12XX | Candela İkili Priz Çerçeve | 12 | 60 | 7.85 |

OLIM

CANDELA

DARIA

RITA

NEMLIYER

OLIM



ER

BRON

ELITRA

PLUS

CANDELA

RITA

BRON

NEMLIYER

OLIM

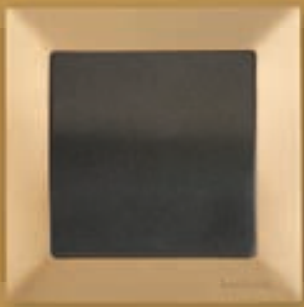

Zarif tasarımlarımızla,
Kendi kombinini oluştur...

US
CANDELA
DARIA
BRON
NEMLIYER

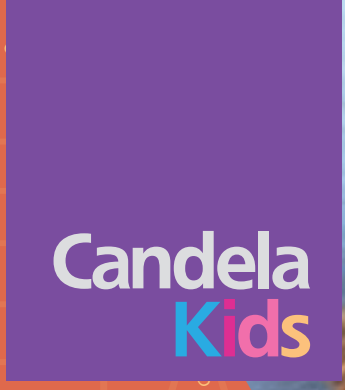

CANDELA
NEMLIYER
OLIMPIYER
RITA EL



PRIZLER
BRON
ELITRA PLUS
CANDELA
DARIA
BRON
NEMLIYER
OLIMPIYER



BEYAZ

| Kod | Ürün Tanımı | Kutu Adedi | Koli Adedi | Fiyat |
|---------------|--------------------------------|------------|------------|-------|
| 2127 510 0101 | Candela Kids -Traffic -Beyaz | 12 | 120 | 17,75 |
| 2127 512 0101 | Candela Kids -Train -Beyaz | 12 | 120 | 17,75 |
| 2127 514 0101 | Candela Kids -Caretta -Beyaz | 12 | 120 | 17,75 |
| 2127 516 0101 | Candela Kids -Balloon -Beyaz | 12 | 120 | 17,75 |
| 2127 518 0101 | Candela Kids -Dolphin -Beyaz | 12 | 120 | 17,75 |
| 2127 520 0101 | Candela Kids -Sea Horse -Beyaz | 12 | 120 | 17,75 |
| 2127 522 0101 | Candela Kids -Love -Beyaz | 12 | 120 | 17,75 |
| 2127 524 0101 | Candela Kids -Cow -Beyaz | 12 | 120 | 17,75 |
| 2127 526 0101 | Candela Kids -Carousel -Beyaz | 12 | 120 | 17,75 |
| 2127 528 0101 | Candela Kids -Diver -Beyaz | 12 | 120 | 17,75 |

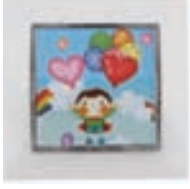

PEMBE

| Kod | Ürün Tanımı | Kutu Adedi | Koli Adedi | Fiyat |
|---------------|--------------------------------|------------|------------|-------|
| 2127 510 0111 | Candela Kids -Traffic -Pembe | 12 | 120 | 17,75 |
| 2127 512 0111 | Candela Kids -Train -Pembe | 12 | 120 | 17,75 |
| 2127 514 0111 | Candela Kids -Caretta -Pembe | 12 | 120 | 17,75 |
| 2127 516 0111 | Candela Kids -Balloon -Pembe | 12 | 120 | 17,75 |
| 2127 518 0111 | Candela Kids -Dolphin -Pembe | 12 | 120 | 17,75 |
| 2127 520 0111 | Candela Kids -Sea Horse -Pembe | 12 | 120 | 17,75 |
| 2127 522 0111 | Candela Kids -Love -Pembe | 12 | 120 | 17,75 |
| 2127 524 0111 | Candela Kids -Cow -Pembe | 12 | 120 | 17,75 |
| 2127 526 0111 | Candela Kids -Carousel -Pembe | 12 | 120 | 17,75 |
| 2127 528 0111 | Candela Kids -Diver -Pembe | 12 | 120 | 17,75 |



MAVİ

| Kod | Ürün Tanımı | Kutu Adedi | Koli Adedi | Fiyat |
|---------------|-------------------------------|------------|------------|-------|
| 2127 510 0112 | Candela Kids -Traffic -Mavi | 12 | 120 | 17,75 |
| 2127 512 0112 | Candela Kids -Train -Mavi | 12 | 120 | 17,75 |
| 2127 514 0112 | Candela Kids -Caretta -Mavi | 12 | 120 | 17,75 |
| 2127 516 0112 | Candela Kids -Balloon -Mavi | 12 | 120 | 17,75 |
| 2127 518 0112 | Candela Kids -Dolphin -Mavi | 12 | 120 | 17,75 |
| 2127 520 0112 | Candela Kids -Sea Horse -Mavi | 12 | 120 | 17,75 |
| 2127 522 0112 | Candela Kids -Love -Mavi | 12 | 120 | 17,75 |
| 2127 524 0112 | Candela Kids -Cow -Mavi | 12 | 120 | 17,75 |
| 2127 526 0112 | Candela Kids -Carousel -Mavi | 12 | 120 | 17,75 |
| 2127 528 0112 | Candela Kids -Diver -Mavi | 12 | 120 | 17,75 |



Gündüz



Carousel 2127-526-XX

Gece

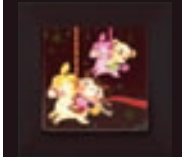

Gündüz



Traffic 2127-510-XX

Gece

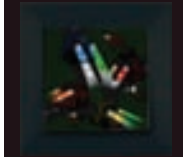

Gündüz



Train 2127-512-XX

Gece

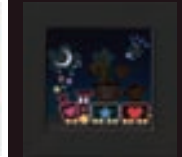

Cow 2127-524-XX

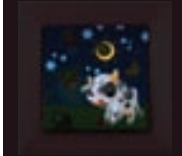

Balloon 2127-516-XX

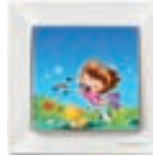
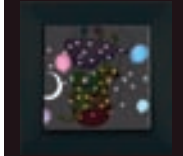

Diver 2127-528-XX

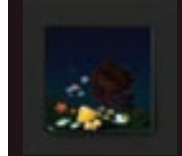

Sea Horse 2127-520-XX

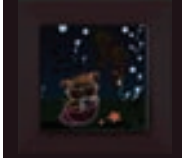

Love 2127-522-XX

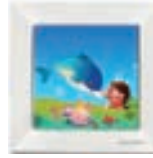
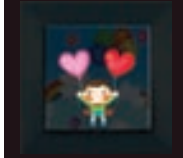

Dolphin 2127-518-XX

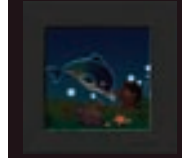

Daria



RITA NEMLIYER OLIMPIA LIVA FIS PRIZLER BR

CANDELA
LITRA E
DARIA
OLIMPIA

| Kod | Ürün Tanımı | Kutu Adedi | Koli Adedi | Beyaz/Krem Fiyat | Metalik Fiyat | Ahşap Fiyat |
|----------------|---|------------|------------|------------------|---------------|-------------|
| 2120 001 01XX | Daria Anahtar | 12 | 120 | 6.23 | 10.11 | 10.51 |
| 2120 002 01XX | Daria Komütatör | 12 | 120 | 8.09 | 11.62 | 12.09 |
| 2120 003 01XX | Daria Vavien (İki Yollu Anahtar) | 12 | 120 | 8.30 | 11.54 | 12.01 |
| 2120 004 02XX | Daria Komütatör Vavien | 12 | 120 | 12.55 | 16.00 | 16.69 |
| 2120 005 01XX | Daria Çift Kutuplu Anahtar | 12 | 120 | 8.71 | 11.62 | 12.09 |
| 2120 006 01XX | Daria Jaluzi Anahtarı-Yaylı | 12 | 120 | 12.00 | 16.34 | 17.05 |
| 2120 007 01XX | Daria Light (Çağırma) | 12 | 120 | 8.02 | 10.96 | 11.40 |
| 2120 007 01XXZ | Daria Zil Anahtarı | 12 | 120 | 8.02 | 10.96 | 11.40 |
| 2120 007 01XXK | Daria Kapı Otomatik Anahtarı | 12 | 120 | 8.02 | 10.96 | 11.40 |
| 2120 008 01XX | Daria Deviyatör (Ara Vavien) | 12 | 120 | 11.67 | 15.74 | 16.42 |
| 2120 009 02XX | Daria Üçlü Anahtar | 12 | 120 | 11.32 | 16.13 | 16.82 |
| 2120 011 02XX | Daria Şofben Anahtarı | 12 | 120 | 8.46 | 11.81 | 12.29 |
| 2120 015 01XX | Daria Işıklı Anahtar (220V) | 12 | 120 | 10.91 | 14.70 | 15.33 |
| 2120 016 01XX | Daria Işıklı Vavien (220V) | 12 | 120 | 12.69 | 15.59 | 16.27 |
| 2120 017 01XX | Daria Işıklı Çağırma(220V) | 12 | 120 | 11.18 | 15.89 | 16.58 |
| 2120 018 01XX | Daria Işıklı Etiketli Anahtar (220V) | 12 | 120 | 11.32 | 13.95 | 14.54 |
| 2120 019 01XX | Daria Işıklı Etiketli Çağırma (220V) | 12 | 120 | 11.45 | 13.95 | 14.54 |
| 2120 022 01XX | Daria Işıklı Zil Etiketli (ağırma)(12V) | 12 | 120 | 10.99 | 13.95 | 14.54 |
| 2120 026 01XX | Daria Işıklı Komütatör | 12 | 120 | 13.92 | 17.69 | 18.98 |

Dimmer Grubu

| | | | | | | |
|---------------|---------------------------|----|---|-------|-------|-------|
| 2120 040 02XX | Daria Işıklı Dimmer 600W | 12 | 8 | 46.93 | 49.30 | 51.66 |
| 2120 044 02XX | Daria Işıklı Dimmer 1000W | 12 | 8 | 58.64 | 61.52 | 64.49 |

Elektronik Grubu

| | | | | | | |
|---------------|--------------------------------------|----|-----|-------|-------|-------|
| 2120 050 01XX | Daria Energy Saver Gecikmesiz Işıklı | 8 | 80 | 66.87 | 70.14 | 73.53 |
| 2120 052 01XX | Daria Energy Saver Gecikmeli | 8 | 80 | 66.87 | 70.14 | 75.15 |
| 2120 070 02XX | Daria Müzik Yayın Anahtarı | 8 | 80 | 51.78 | 59.95 | 62.84 |
| 2120 080 01XX | Daria Hoparlör Prizi | 12 | 120 | 20.78 | 27.56 | 28.83 |
| 2120 085 02XX | Daria Uyan Zili | 12 | 120 | 40.81 | 47.34 | 49.60 |
| 2120 095 02XX | Daria Hareket Sensörü | 12 | 120 | 77.85 | 91.32 | 95.78 |

Priz Grubu

| | | | | | | |
|---------------|---|----|-----|-------|-------|-------|
| 2120 100 02XX | Daria Topraklı Priz | 10 | 100 | 7.06 | 11.18 | 11.63 |
| 2120 101 02XX | Daria Topraksız Priz | 10 | 100 | 6.43 | 10.17 | 10.57 |
| 2120 105 02XX | Daria Topraklı Priz (Çocuk Kor.) | 10 | 100 | 8.98 | 14.37 | 16.42 |
| 2120 106 02XX | Daria Topraksız Priz (Çocuk Kor.) | 10 | 100 | 8.02 | 12.84 | 14.66 |
| 2120 110 02XX | Daria Kapaklı Topraklı Priz | 10 | 100 | 8.44 | 12.09 | 12.58 |
| 2120 111 02XX | Daria Kapaklı Topraklı Priz (Çoc.Kor) | 10 | 100 | 10.36 | 16.25 | 17.18 |
| 2120 115 02XX | Daria Ups (Fransız) Prizi | 10 | 100 | 8.44 | 15.05 | 15.69 |
| 2120 116 02XX | Daria Ups (Fransız) Prizi (Çocuk Kor.) | 10 | 100 | 9.86 | 16.34 | 17.05 |
| 2120 117 02XX | Daria Ups Kapaklı (Fransız) Priz | 10 | 100 | 10.02 | 17.31 | 18.07 |
| 2120 118 02XX | Daria Ups Kapaklı (Fr.) Priz (Çocuk Kor.) | 10 | 100 | 10.22 | 19.04 | 19.88 |
| 2120 121 01XX | Daria Kör Kapak | 12 | 120 | 5.97 | 13.38 | 13.94 |
| 2120 200 02XX | Daria İkili Topraklı Priz Porselen | 5 | 50 | 11.57 | 16.83 | 16.34 |
| 2120 201 02XX | Daria İkili Topraksız Priz Porselen | 5 | 50 | 9.84 | 15.91 | 15.34 |
| 2120 202 02XX | Daria İkili Topraklı Priz | 5 | 50 | 10.47 | 15.50 | 14.68 |
| 2120 203 02XX | Daria İkili Topraksız Priz | 5 | 50 | 8.65 | 13.17 | 12.24 |
| 2120 215 02XX | Daria İkili Ups (Fransız) Priz | 5 | 50 | 12.10 | 17.28 | 16.56 |

İletişim Grubu

| | | | | | | |
|---------------|--|----|-----|-------|-------|-------|
| 2120 055 01XX | Daria Data Prizi 1*Usb | 12 | 120 | 23.80 | 25.06 | 26.21 |
| 2120 056 01XX | Daria Data Prizi 2*Usb | 12 | 120 | 40.71 | 41.17 | 43.12 |
| 2120 057 01XX | Daria Data Prizi 1*Hdmi | 12 | 120 | 29.56 | 30.96 | 32.40 |
| 2120 058 01XX | Daria Data Prizi 2*Hdmi | 12 | 120 | 51.95 | 52.65 | 55.18 |
| 2120 059 01XX | Daria Data Prizi 1*Usb/1*Hdmi | 12 | 120 | 45.59 | 46.49 | 48.71 |
| 2120 125 01XX | Daria Telefon Prizi 1*Rj12 Cat3 | 12 | 120 | 10.22 | 13.13 | 13.68 |
| 2120 126 01XX | Daria Telefon Prizi 2*Rj12 Cat3 | 12 | 120 | 13.79 | 18.34 | 19.15 |
| 2120 128 01XX | Daria Etiketli Tlf+Data Priz (Kon.süz) | 12 | 120 | 6.52 | 9.77 | 11.62 |
| 2120 135 01XX | Daria Data Prizi 1*Rj45 (Kon.süz) | 12 | 120 | 6.24 | 9.42 | 11.62 |
| 2120 136 01XX | Daria Data Prizi 1*Rj45 (Cat5e) | 12 | 120 | 16.12 | 25.20 | 26.35 |
| 2120 137 01XX | Daria Data Prizi 2*Rj45 (Kon.süz) | 12 | 120 | 6.79 | 9.42 | 11.62 |
| 2120 138 01XX | Daria Data Prizi 2*Rj45 (Cat5e) | 12 | 120 | 25.72 | 38.37 | 40.18 |
| 2120 139 01XX | Daria Tlf+Data Priz (Rj12 Cat3+Cat5e) | 12 | 120 | 21.06 | 33.87 | 35.46 |
| 2120 140 01XX | Daria Data Prizi 1*Rj45 (Cat6) | 12 | 120 | 18.53 | 25.20 | 26.35 |
| 2120 141 01XX | Daria Data Prizi 2*Rj45 (Cat6) | 12 | 120 | 32.68 | 38.37 | 40.18 |

TV / Sat Grubu

| | | | | | | |
|---------------|------------------------------|----|-----|-------|-------|-------|
| 2120 156 02XX | Daria Tv-Sat Prizi (Geçişli) | 12 | 120 | 37.92 | 46.88 | 49.12 |
| 2120 157 02XX | Daria Tv-Sat Prizi (Sonlu) | 12 | 120 | 37.92 | 46.88 | 49.12 |
| 2120 166 01XX | Daria Sat Prizi (Geçişli) | 12 | 120 | 20.23 | 26.21 | 27.41 |
| 2120 167 01XX | Daria Sat Prizi (Sonlu) | 12 | 120 | 20.23 | 26.21 | 27.41 |
| 2120 170 01XX | Daria Tv Prizi (Geçişli) | 12 | 120 | 12.64 | 15.76 | 16.44 |
| 2120 171 01XX | Daria Tv Prizi (Sonlu) | 12 | 120 | 12.64 | 15.76 | 16.44 |
| 2120 172 01XX | Daria Tv Prizi F Dişi | 12 | 120 | 8.30 | 9.56 | 11.32 |

Çerçeveler

| | | | | | | |
|---------------|----------------------------|----|-----|------|-------|-------|
| 2120 800 11XX | Daria Tekli Çerçeve | 20 | 400 | 1.03 | 2.15 | 3.98 |
| 2120 800 12XX | Daria İkili Yatay Çerçeve | 10 | 200 | 3.20 | 3.98 | 7.19 |
| 2120 800 13XX | Daria Üçlü Yatay Çerçeve | 10 | 50 | 4.12 | 7.93 | 9.71 |
| 2120 800 14XX | Daria Dörtlü Yatay Çerçeve | 10 | 50 | 5.08 | 9.96 | 12.35 |
| 2120 800 15XX | Daria Beşli Yatay Çerçeve | 10 | 50 | 6.45 | 12.80 | 13.85 |
| 2120 800 16XX | Daria Altılı Yatay Çerçeve | 10 | 50 | 8.50 | 16.85 | 16.80 |
| 2120 800 22XX | Daria İkili Dikey Çerçeve | 10 | 50 | 3.20 | 3.98 | 7.19 |
| 2120 800 23XX | Daria Üçlü Dikey Çerçeve | 10 | 50 | 4.12 | 7.93 | 9.71 |
| 2120 800 24XX | Daria Dörtlü Dikey Çerçeve | 10 | 50 | 5.08 | 9.96 | 12.35 |
| 2120 800 25XX | Daria Beşli Dikey Çerçeve | 10 | 50 | 6.45 | 12.80 | 13.85 |
| 2120 800 26XX | Daria Altılı Dikey Çerçeve | 10 | 50 | 8.50 | 16.85 | 16.80 |
| 2100 000 11XX | Sıva Üstü Kasa | 10 | 50 | 2.70 | 5.42 | 6.26 |



Beyaz 01
Krem 02



Gümüş Saten 92
Füme 90
95



Kiraz 56
Ceviz 57
Meşe 58

BRON



BRON
NEMLIYE
OLIMPIYA
ELITRA

PRIZLER
BRON
ELITRA PLUS
CANDELA
RITA
BRON
NEMLIYER
OLIMP



Beyaz 01
Krem 02



Meşe 58
Ceviz 57

BRON

Sıva Üstü Anahtar Priz Serisi

Beyaz / Krem Ürün Listesi

| Kod | Ürün Tanımı | Kutu Adedi | Koli Adedi | Fiyat |
|---------------|--|------------|------------|-------|
| 2160 301 02XX | Bron S/Ü Anahtar | 12 | 120 | 5.52 |
| 2160 302 02XX | Bron S/Ü Komütatör | 12 | 120 | 6.77 |
| 2160 303 02XX | Bron S/Ü Vavien | 12 | 120 | 6.41 |
| 2160 307 02XX | Bron S/Ü Light (Çağırma) | 12 | 120 | 5.81 |
| 2160 315 02XX | Bron S/Ü Işıklı Anahtar (220V) | 12 | 120 | 9.34 |
| 2160 316 02XX | Bron S/Ü Işıklı Vavien (220V) | 12 | 120 | 10.12 |
| 2160 317 02XX | Bron S/Ü Işıklı Light (Çağırma) (220V) | 12 | 120 | 9.77 |
| 2160 326 02XX | Bron S/Ü Işıklı Komütatör | 12 | 120 | 10.87 |
| 2160 100 02XX | Bron S/Ü Topraklı Priz | 12 | 120 | 6.32 |
| 2160 101 02XX | Bron S/Ü Topraksız Priz | 12 | 120 | 6.65 |
| 2160 103 02XX | Bron S/Ü Top.İ Priz Porselen | 12 | 120 | 7.99 |
| 2160 104 02XX | Bron S/Ü Top.sız Priz Porselen | 12 | 120 | 7.16 |
| 2160 110 02XX | Bron S/Ü Kapaklı Top.İ Priz | 12 | 120 | 7.14 |
| 2160 113 02XX | Bron S/Ü Kapaklı Top.İ Priz Porselen | 12 | 120 | 8.80 |
| 2160 115 02XX | Bron S/Ü Ups (Fransız) Priz | 12 | 120 | 6.61 |
| 2160 125 02XX | Bron S/Ü Telefon Prizi 1*Rj12 Cat3 | 12 | 120 | 7.61 |
| 2160 136 02XX | Bron S/Ü Data Prizi 1*Rj45 (Cat5) | 12 | 120 | 10.43 |
| 2160 166 02XX | Bron S/Ü Sat Prizi (Geçişli) 4Db/F Konnektör | 12 | 120 | 18.24 |
| 2160 167 02XX | Bron S/Ü Sat Prizi (Sonlu) | 12 | 120 | 18.24 |
| 2160 170 02XX | Bron S/Ü Tv Prizi (Geçişli) | 12 | 120 | 13.68 |
| 2160 171 02XX | Bron S/Ü Tv Prizi (Sonlu) | 12 | 120 | 13.68 |
| 2160 200 02XX | Bron S/Ü İkili Top.İ Priz Porselen | 12 | 120 | 12.07 |
| 2160 201 02XX | Bron İkili Topraksız Priz Porselen | 12 | 120 | 12.07 |
| 2160 202 02XX | Bron S/Ü İkili Topraklı Priz | 12 | 120 | 9.49 |
| 2160 203 02XX | Bron S/Ü İkili Topraksız Priz | 12 | 120 | 7.96 |
| 2160 215 02XX | Bron S/Ü İkili Ups (Fransız) Priz | 12 | 120 | 9.80 |

BRON

Sıva Üstü Anahtar Priz Serisi

Meşe / Ceviz Ürün Listesi

| Kod | Ürün Tanımı | Kutu Adedi | Koli Adedi | Fiyat |
|---------------|--|------------|------------|-------|
| 2160 301 02XX | Bron S/Ü Anahtar | 12 | 120 | 11.52 |
| 2160 302 02XX | Bron S/Ü Komütatör | 12 | 120 | 13.44 |
| 2160 303 02XX | Bron S/Ü Vavien | 12 | 120 | 12.76 |
| 2160 307 02XX | Bron S/Ü Light (Çağırma) | 12 | 120 | 11.80 |
| 2160 315 02XX | Bron S/Ü Işıklı Anahtar (220V) | 12 | 120 | 15.09 |
| 2160 316 02XX | Bron S/Ü Işıklı Vavien (220V) | 12 | 120 | 15.91 |
| 2160 317 02XX | Bron S/Ü Işıklı Light (Çağırma) (220V) | 12 | 120 | 15.36 |
| 2160 326 02XX | Bron S/Ü Işıklı Komütatör | 12 | 120 | 17.28 |
| 2160 100 02XX | Bron S/Ü Topraklı Priz | 12 | 120 | 13.72 |
| 2160 101 02XX | Bron S/Ü Topraksız Priz | 12 | 120 | 10.97 |
| 2160 103 02XX | Bron S/Ü Top.İ Priz Porselen | 12 | 120 | 12.83 |
| 2160 104 02XX | Bron S/Ü Top.sız Priz Porselen | 12 | 120 | 11.63 |
| 2160 110 02XX | Bron S/Ü Kapaklı Top.İ Priz | 12 | 120 | 14.27 |
| 2160 113 02XX | Bron S/Ü Kapaklı Top.İ Priz Porselen | 12 | 120 | 16.20 |
| 2160 115 02XX | Bron S/Ü Ups (Fransız) Priz | 12 | 120 | 11.50 |
| 2160 125 02XX | Bron S/Ü Telefon Prizi 1*Rj12 | 12 | 120 | 14.54 |
| 2160 136 02XX | Bron S/Ü Data Prizi 1*Rj45 (Cat5) | 12 | 120 | 24.69 |
| 2160 166 02XX | Bron S/Ü Sat Prizi (Geçişli) 4Db/F Konnektör | 12 | 120 | 19.89 |
| 2160 167 02XX | Bron S/Ü Sat Prizi (Sonlu) | 12 | 120 | 19.89 |
| 2160 170 02XX | Bron S/Ü Tv Prizi (Geçişli) | 12 | 120 | 17.01 |
| 2160 171 02XX | Bron S/Ü Tv Prizi (Sonlu) | 12 | 120 | 17.01 |
| 2160 200 02XX | Bron S/Ü İkili Top.İ Priz Porselen | 12 | 120 | 20.58 |
| 2160 201 02XX | Bron İkili Topraksız Priz Porselen | 12 | 120 | 16.46 |
| 2160 202 02XX | Bron S/Ü İkili Topraklı Priz | 12 | 120 | 18.93 |
| 2160 203 02XX | Bron S/Ü İkili Topraksız Priz | 12 | 120 | 15.09 |
| 2160 215 02XX | Bron S/Ü İkili Ups (Fransız) Priz | 12 | 120 | 20.85 |

PLUS

CANDELA

DARIA

RITA

NEMLIYER

BRON

NEMLIYER

OLIMPIYER

RITA ELIYER

PRIZLER

ELITRA PLUS

CANDELA

DARIA

BRON

NEMLIYER

OLIMPIYER

Nemliyer



Nemliyer Natural

Beyaz / Gri Ürün Listesi

| Kod | Ürün Tanımı | Kutu Adedi | Koli Adedi | Fiyat |
|---------------|------------------------------------|------------|------------|-------|
| 2150 001 01XX | Anahtar Nemliyer | 12 | 120 | 7.85 |
| 2150 002 01XX | Komütatör Nemliyer | 12 | 120 | 9.24 |
| 2150 003 01XX | Vavien(iki Yollu Anahtar) Nemliyer | 12 | 120 | 9.49 |
| 2150 005 01XX | Çift Kutup. Anahtar Nemliyer | 12 | 120 | 8.98 |
| 2150 007 01XX | Çağırma Nemliyer | 12 | 120 | 8.17 |
| 2150 008 01XX | Deviatör(Ara Vavien) Nemliyer | 12 | 120 | 11.90 |
| 2150 110 02XX | Kap.lı Top.lı Priz Nemliyer | 12 | 120 | 8.51 |
| 2150 115 02XX | Ups Kapaklı Top.lı Priz Nemliyer | 12 | 120 | 9.77 |
| 2150 125 02XX | Telefon Prizi 1*Rj12 Nemliyer | 12 | 120 | 8.96 |
| 2150 136 01XX | Data Prizi 1*Rj45 (Cat5e) Nemliyer | 12 | 120 | 10.44 |
| 2150 166 02XX | Sat Prizi (Geçişli) Nemliyer | 12 | 120 | 17.28 |
| 2150 167 02XX | Sat Prizi (Sonlu) Nemliyer | 12 | 120 | 17.28 |
| 2150 170 02XX | Tv Prizi (Geçişli) Nemliyer | 12 | 120 | 13.34 |
| 2150 171 02XX | Tv Prizi (Sonlu) Nemliyer | 12 | 120 | 13.34 |



Beyaz-01

Gri-03

Nemliyer Ahşap

Ahşap Ürün Listesi

| Kod | Ürün Tanımı | Kutu Adedi | Koli Adedi | Fiyat |
|---------------|--|------------|------------|-------|
| 2150 001 01XX | Anahtar Nemliyer Ahşap | 12 | 120 | 10.71 |
| 2150 002 01XX | Komütatör Nemliyer Ahşap | 12 | 120 | 12.70 |
| 2150 003 01XX | Vavien(iki Yollu Anahtar) Nemliyer Ahşap | 12 | 120 | 12.46 |
| 2150 005 01XX | Çift Kutup. Anahtar Nemliyer Ahşap | 12 | 120 | 11.91 |
| 2150 007 01XX | Çağırma Nemliyer Ahşap | 12 | 120 | 11.04 |
| 2150 008 01XX | Deviatör(Ara Vavien) Nemliyer Ahşap | 12 | 120 | 15.02 |
| 2150 110 02XX | Kap.lı Top.lı Priz Nemliyer Ahşap | 12 | 120 | 11.36 |
| 2150 115 02XX | Ups Kapaklı Top.lı Priz Nemliyer Ahşap | 12 | 120 | 12.76 |
| 2150 125 02XX | Telefon Prizi 1*Rj12 Cat3 Nemliyer Ahşap | 12 | 120 | 12.18 |
| 2150 136 01XX | Data Prizi 1*Rj45 (Cat5e) Nemliyer Ahşap | 12 | 120 | 13.11 |
| 2150 166 02XX | Sat Prizi (Geçişli) Nemliyer Ahşap | 12 | 120 | 19.93 |
| 2150 167 02XX | Sat Prizi (Sonlu) Nemliyer Ahşap | 12 | 120 | 19.93 |
| 2150 170 02XX | Tv Prizi (Geçişli) Nemliyer Ahşap | 12 | 120 | 15.75 |
| 2150 171 02XX | Tv Prizi (Sonlu) Nemliyer Ahşap | 12 | 120 | 15.75 |

MUT-40
AÇIK KAYINMUT-41
KOCU CEVİZMUT-43
MERBAUMUT-44
MAUNMUT-49
ARMUT

PLUS
CANDELA
DARIA
RITA
NEMLIYER

Fiş Prizler



PRIZLER
BRON
ELITRA PLUS
CANDELA
RITA
BRON
NEMLIYER
OLIMPIYER



| Kod | Ürün Tanımı | Kutu Adedi | Fiyat |
|----------------------|--|------------|-------|
| 001 171 290001 00 00 | İkili Topraksız Grup Priz (Klemensli) Olimpia | 12 | 4.97 |
| 001 171 290002 02 00 | İkili Topraksız Grup Priz (2Mt) Olimpia | 12 | 9.73 |
| 001 171 290002 03 00 | İkili Topraksız Grup Priz (3Mt) Olimpia | 12 | 11.55 |
| 001 171 290002 05 00 | İkili Topraksız Grup Priz (5Mt) Olimpia | 12 | 14.99 |
| 001 171 390001 00 00 | Üçlü Topraksız Grup Priz (Klemensli) Olimpia | 12 | 5.47 |
| 001 171 390002 02 00 | Üçlü Topraksız Grup Priz (2Mt) Olimpia | 12 | 10.42 |
| 001 171 390002 03 00 | Üçlü Topraksız Grup Priz(3Mt) Olimpia | 12 | 12.10 |
| 001 171 390002 05 00 | Üçlü Topraksız Grup Priz (5Mt) Olimpia | 12 | 15.66 |
| 001 171 210001 00 00 | İkili Topraklı Grup Priz (Klemensli) Olimpia | 12 | 6.79 |
| 001 171 210002 02 00 | İkili Topraklı Grup Priz (2Mt) Olimpia | 12 | 14.43 |
| 001 171 210002 03 00 | İkili Topraklı Grup Priz (3Mt) Olimpia | 12 | 17.34 |
| 001 171 210002 05 00 | İkili Topraklı Grup Priz (5Mt) Olimpia | 12 | 23.29 |
| 001 171 310001 00 00 | Üçlü Grup Priz Topraklı (Klemensli) Olimpia | 12 | 8.04 |
| 001 171 310002 02 00 | Üçlü Topraklı Grup Priz (2Mt) Olimpia | 12 | 15.91 |
| 001 171 310002 03 00 | Üçlü Topraklı Grup Priz (3Mt) Olimpia | 12 | 18.82 |
| 001 171 310002 05 00 | Üçlü Topraklı Grup Priz (5Mt) Olimpia | 12 | 24.75 |
| 001 171 320001 00 00 | Üçlü Topraklı Grup Priz (Klemensli Anahtarlı) Olimpia | 12 | 13.21 |
| 001 171 320002 02 00 | Üçlü Topraklı Grup Priz (Anahtarlı 2 Mt) Olimpia | 12 | 21.05 |
| 001 171 320002 03 00 | Üçlü Topraklı Grup Priz (Anahtarlı 3 Mt) Olimpia | 12 | 23.96 |
| 001 171 320002 05 00 | Üçlü Topraklı Grup Priz (Anahtarlı 5 Mt) Olimpia | 12 | 29.89 |
| 001 171 340001 00 00 | Üçlü Ups Grup Priz (Klemensli) Olimpia | 12 | 7.19 |
| 001 171 330001 02 00 | Üçlü Ups Grup Priz (2Mt) Olimpia | 12 | 15.91 |
| 001 171 330001 03 00 | Üçlü Ups Grup Priz (3Mt) Olimpia | 12 | 19.06 |
| 001 171 330001 05 00 | Üçlü Ups Grup Priz (5Mt) Olimpia | 12 | 24.85 |
| 001 171 410001 00 00 | Dörtlü Topraklı Grup Priz (Klemensli) Olimpia | 12 | 10.16 |
| 001 171 410001 02 00 | Dörtlü Topraklı Grup Priz (2Mt) Olimpia | 12 | 17.99 |
| 001 171 410001 03 00 | Dörtlü Topraklı Grup Priz (3Mt) Olimpia | 12 | 20.90 |
| 001 171 410001 05 00 | Dörtlü Topraklı Grup Priz (5Mt) Olimpia | 12 | 26.83 |
| 001 171 410002 00 00 | Dörtlü Topraklı Grup Priz (Klemensli-Anahta Olimpia | 12 | 15.28 |
| 001 171 410002 02 00 | Dörtlü Topraklı Grup Priz (Anahtarlı 2 Mt) Olimpia | 12 | 22.97 |
| 001 171 410002 03 00 | Dörtlü Topraklı Grup Priz (Anahtarlı 3 Mt) Olimpia | 12 | 26.19 |
| 001 171 410002 05 00 | Dörtlü Topraklı Grup Priz (Anahtarlı 5 Mt) Olimpia | 12 | 31.81 |
| 001 171 610001 00 00 | Altılı Grup Priz Topraklı (Klemensli) Olimpia | 12 | 13.71 |
| 001 171 610001 02 00 | Altılı Topraklı Grup Priz (2 Mt) Olimpia | 12 | 23.91 |
| 001 171 610001 03 00 | Altılı Topraklı Grup Priz (3 Mt) Olimpia | 12 | 27.91 |
| 001 171 610001 05 00 | Altılı Topraklı Grup Priz (5 Mt) Olimpia | 12 | 35.97 |
| 001 171 610002 00 00 | Altılı Topraklı Grup Priz (Klemensli-Anahtarlı Olimpia | 12 | 18.63 |
| 001 171 610002 02 00 | Altılı Topraklı Grup Priz (Anahtarlı 2 Mt) Olimpia | 12 | 28.83 |
| 001 171 610002 03 00 | Altılı Topraklı Grup Priz (Anahtarlı 3 Mt) Olimpia | 12 | 32.83 |
| 001 171 610002 05 00 | Altılı Topraklı Grup Priz (Anahtarlı 5 Mt) Olimpia | 12 | 40.89 |
| 001 171 614001 02 00 | Altılı Topraklı Grup Priz (2 Mt) (3X1,5mm ²) Olimpia | 12 | 24.03 |
| 001 171 614001 03 00 | Altılı Topraklı Grup Priz (3 Mt) (3X1,5mm ²) Olimpia | 12 | 28.03 |
| 001 171 614001 05 00 | Altılı Topraklı Grup Priz (5 Mt) (3X1,5mm ²) Olimpia | 12 | 35.97 |
| 001 171 614002 02 00 | Altılı Topraklı Grup Priz (Anahtarlı 2 Mt) (3X1,5mm ²) Olimpia | 12 | 28.84 |
| 001 171 614002 03 00 | Altılı Topraklı Grup Priz (Anahtarlı 3 Mt) (3X1,5mm ²) Olimpia | 12 | 32.95 |
| 001 171 614002 05 00 | Altılı Topraklı Grup Priz (Anahtarlı 5 Mt) (3X1,5mm ²) Olimpia | 12 | 40.89 |

| Kod | Ürün Tanımı | Kutu Adedi | Fiyat |
|----------------------|--|------------|-------|
| 001 170 310001 00 00 | Üçlü Grup Priz (Klemensli) | 12 | 8.84 |
| 001 170 310001 02 00 | Üçlü Grup Priz (2 Mt) | 12 | 20.68 |
| 001 170 310001 03 00 | Üçlü Grup Priz (3 Mt) | 12 | 24.04 |
| 001 170 310001 05 00 | Üçlü Grup Priz (5 Mt) | 12 | 30.77 |
| 001 170 320001 00 00 | Üçlü Grup Priz (Anahtarlı) | 12 | 14.05 |
| 001 170 320001 02 00 | Üçlü Grup Priz (Anahtarlı 2 Mt) | 12 | 25.50 |
| 001 170 320001 03 00 | Üçlü Grup Priz (Anahtarlı 3 Mt) | 12 | 28.86 |
| 001 170 320001 05 00 | Üçlü Grup Priz (Anahtarlı 5 Mt) | 12 | 35.60 |
| 001 170 340001 00 00 | Üçlü Ups Grup Priz (Klemensli) | 12 | 10.32 |
| 001 170 330001 02 00 | Üçlü Ups Grup Priz (2 Mt) | 12 | 21.82 |
| 001 170 330001 03 00 | Üçlü Ups Grup Priz (3 Mt) | 12 | 25.46 |
| 001 170 330001 05 00 | Üçlü Ups Grup Priz (5 Mt) | 12 | 32.14 |
| 001 170 350001 00 00 | Üçlü Ups Grup Priz (Klemensli-Anahtarlı) | 12 | 14.82 |
| 001 170 360001 02 00 | Üçlü Ups Grup Priz (Anahtarlı 2 Mt) | 12 | 26.65 |
| 001 170 360001 03 00 | Üçlü Ups Grup Priz (Anahtarlı 3 Mt) | 12 | 30.28 |
| 001 170 360001 05 00 | Üçlü Ups Grup Priz (Anahtarlı 5 Mt) | 12 | 36.97 |
| 001 170 410001 00 00 | Dörtlü Grup Priz (Klemensli) | 12 | 11.14 |
| 001 170 410001 02 00 | Dörtlü Grup Priz (2 Mt) | 12 | 23.37 |
| 001 170 410001 03 00 | Dörtlü Grup Priz (3 Mt) | 12 | 26.73 |
| 001 170 410001 05 00 | Dörtlü Grup Priz (5 Mt) | 12 | 33.42 |
| 001 170 420001 00 00 | Dörtlü Grup Priz (Anahtarlı) | 12 | 15.72 |
| 001 170 410002 02 00 | Dörtlü Grup Priz (Anahtarlı 2 Mt) | 12 | 28.34 |
| 001 170 410002 03 00 | Dörtlü Grup Priz (Anahtarlı 3 Mt) | 12 | 31.70 |
| 001 170 410002 05 00 | Dörtlü Grup Priz (Anahtarlı 5 Mt) | 12 | 38.43 |
| 001 170 440001 00 00 | Dörtlü Ups Grup Priz (Klemensli) | 12 | 13.13 |
| 001 170 430001 02 00 | Dörtlü Ups Grup Priz (2 Mt) | 12 | 24.81 |
| 001 170 430001 03 00 | Dörtlü Ups Grup Priz (3 Mt) | 12 | 28.40 |
| 001 170 430001 05 00 | Dörtlü Ups Grup Priz (5 Mt) | 12 | 35.14 |
| 001 170 450001 00 00 | Dörtlü Ups Grup Priz (Klemensli-Anahtarlı) | 12 | 17.71 |
| 001 170 460001 02 00 | Dörtlü Ups Grup Priz (Anahtarlı 2 Mt) | 12 | 29.73 |
| 001 170 460001 03 00 | Dörtlü Ups Grup Priz (Anahtarlı 3 Mt) | 12 | 33.37 |
| 001 170 460001 05 00 | Dörtlü Ups Grup Priz (Anahtarlı 5 Mt) | 12 | 40.06 |
| 001 170 610001 00 00 | Altılı Grup Priz (Klemensli) | 12 | 17.35 |
| 001 170 610001 02 00 | Altılı Grup Priz (2 Mt) | 12 | 32.43 |
| 001 170 610001 03 00 | Altılı Grup Priz (3 Mt) | 12 | 37.05 |
| 001 170 610001 05 00 | Altılı Grup Priz (5 Mt) | 12 | 46.24 |
| 001 170 620001 00 00 | Altılı Grup Priz (Anahtarlı) | 12 | 22.00 |
| 001 170 620002 02 00 | Altılı Grup Priz (Anahtarlı 2 Mt) | 12 | 37.46 |
| 001 170 620003 03 00 | Altılı Grup Priz (Anahtarlı 3 Mt) | 12 | 42.09 |
| 001 170 620004 05 00 | Altılı Grup Priz (Anahtarlı 5 Mt) | 12 | 51.27 |
| 001 170 640001 00 00 | Altılı Ups Grup Priz (Klemensli) | 12 | 20.34 |
| 001 170 630001 02 00 | Altılı Ups Grup Priz (2 Mt) | 12 | 34.87 |
| 001 170 630001 03 00 | Altılı Ups Grup Priz (3 Mt) | 12 | 39.45 |
| 001 170 630001 05 00 | Altılı Ups Grup Priz (5 Mt) | 12 | 48.68 |
| 001 170 650001 00 00 | Altılı Ups Grup Priz (Klemensli-Anahtarlı) | 12 | 25.02 |
| 001 170 660001 02 00 | Altılı Ups Grup Priz (Anahtarlı 2 Mt) | 12 | 39.91 |
| 001 170 660001 03 00 | Altılı Ups Grup Priz (Anahtarlı 3 Mt) | 12 | 44.53 |
| 001 170 660001 05 00 | Altılı Ups Grup Priz (Anahtarlı 5 Mt) | 12 | 53.72 |
| 001 170 110001 00 00 | 10 lu Topraklı Grup Priz (Klemensli) | 50 | 30.89 |

Fiş Prizler

Ürün Listesi



| | |
|------------|----------------------|
| Ürün Kodu | 001 170 011001 00 00 |
| Ürün Adı | Topraklı Erkek Fiş |
| Kutu Adedi | 50 |
| Fiyatı | 2.50 |



| | |
|------------|----------------------|
| Ürün Kodu | 001 170 010001 00 00 |
| Ürün Adı | Erkek Fiş |
| Kutu Adedi | 50 |
| Fiyatı | 1.77 |



| | |
|------------|-------------------------------|
| Ürün Kodu | 001 170 012001 00 00 |
| Ürün Adı | Topraklı Erkek Fiş (Kuyruklu) |
| Kutu Adedi | 50 |
| Fiyatı | 2.60 |



| | |
|------------|---------------------------|
| Ürün Kodu | 001 170 011002 00 00 |
| Ürün Adı | Kulplu Topraklı Erkek Fiş |
| Kutu Adedi | 50 |
| Fiyatı | 2.53 |



| | |
|------------|----------------------|
| Ürün Kodu | 001 170 020001 00 00 |
| Ürün Adı | Dişi Fiş |
| Kutu Adedi | 50 |
| Fiyatı | 1.42 |



| | |
|------------|----------------------|
| Ürün Kodu | 001 170 021001 00 00 |
| Ürün Adı | Topraklı Dişi Fiş |
| Kutu Adedi | 50 |
| Fiyatı | 2.88 |



| | |
|------------|--|
| Ürün Kodu | 001 170 033001 00 00 |
| Ürün Adı | Topraklı Üçlü Fiş-Priz (Yonca Tip) (S/A) |
| Kutu Adedi | 50 |
| Fiyatı | 8.29 |



| | |
|------------|--|
| Ürün Kodu | 001 170 033002 00 00 |
| Ürün Adı | Topraklı Üçlü Fiş-Priz (Yonca Tip) (S/U) |
| Kutu Adedi | 50 |
| Fiyatı | 8.02 |



| | |
|------------|-----------------------------------|
| Ürün Kodu | 001 170 033003 00 00 |
| Ürün Adı | İkili Topraklı Fiş-Priz (Düz Tip) |
| Kutu Adedi | 24 |
| Fiyatı | 9.20 |



| | |
|------------|----------------------------------|
| Ürün Kodu | 001 170 033005 00 00 |
| Ürün Adı | Üçlü Topraklı Fiş-Priz (Düz Tip) |
| Kutu Adedi | 24 |
| Fiyatı | 11.11 |



| | |
|------------|---------------------------------|
| Ürün Kodu | 001 170 030002 00 00 |
| Ürün Adı | Adaptör Fiş, Priz (İngiliz Tip) |
| Kutu Adedi | 50 |
| Fiyatı | 0.87 USD |



| | |
|------------|--|
| Ürün Kodu | 001 170 033004 00 00 |
| Ürün Adı | Üçlü Topraklı Fiş-Priz (Düz Tip Anahtarlı) |
| Kutu Adedi | 24 |
| Fiyatı | 16.80 |



| | |
|------------|----------------------|
| Ürün Kodu | 001 170 030001 00 00 |
| Ürün Adı | Arapuar Anahtar |
| Kutu Adedi | 50 |
| Fiyatı | 2.34 |

Elektronik Ürünler



► ENERGY SAVER ÜRÜN LİSTESİ

| Kod | Ürün Tanımı | Kutu Adedi | Fiyat |
|---------------|---|------------|-------------------------------------|
| 2100 850 0000 | Radyo Frekanslı Energy Saver | 1 | MÜŞTERİ TEMSİLİCSİNE FİYAT SORUNUZ. |
| 2100 851 0000 | 2X16A Energy Saver Röle PCB (VRF/FC) | 1 | |
| 2100 852 0000 | 30A+16A Energy Saver Röle PCB (VRF/FC) | 1 | |
| 2100 853 0000 | 3X16A Energy Saver Röle PCB (VRF/FC) | 1 | |
| 2100 854 0000 | 3X16A Energy Saver - DND Röle PCB (VRF/FC) | 1 | |
| 2100 855 0000 | 30A+2X16A Energy Saver - DND Röle PCB (VRF/FC) | 1 | |
| 2110 052 0001 | Energy Saver Kapak | 1 | |
| 2125 010 0101 | Otel Uyanıç Ünitesi Komütatörü (Mekanik) Işıklı | 1 | |
| 2100 012 01XX | Mek+Tuş Impuls Anahtar | 12 | |
| 2100 023 01XX | Mek+Tuş Impuls Komütatör | 12 | |
| 2100 024 01XX | Mek+Tuş Impuls Işıklı Anahtar (220V) | 12 | |
| 2100 027 01XX | Mek+Tuş Impuls Işıklı Komütatör | 12 | |

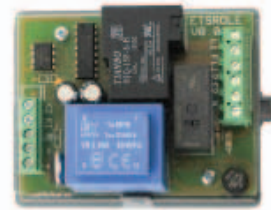
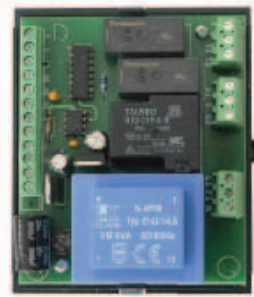



Flame Retardant
Alev Yaymayan

HALOGEN FREE DELİKLİ KANALLAR

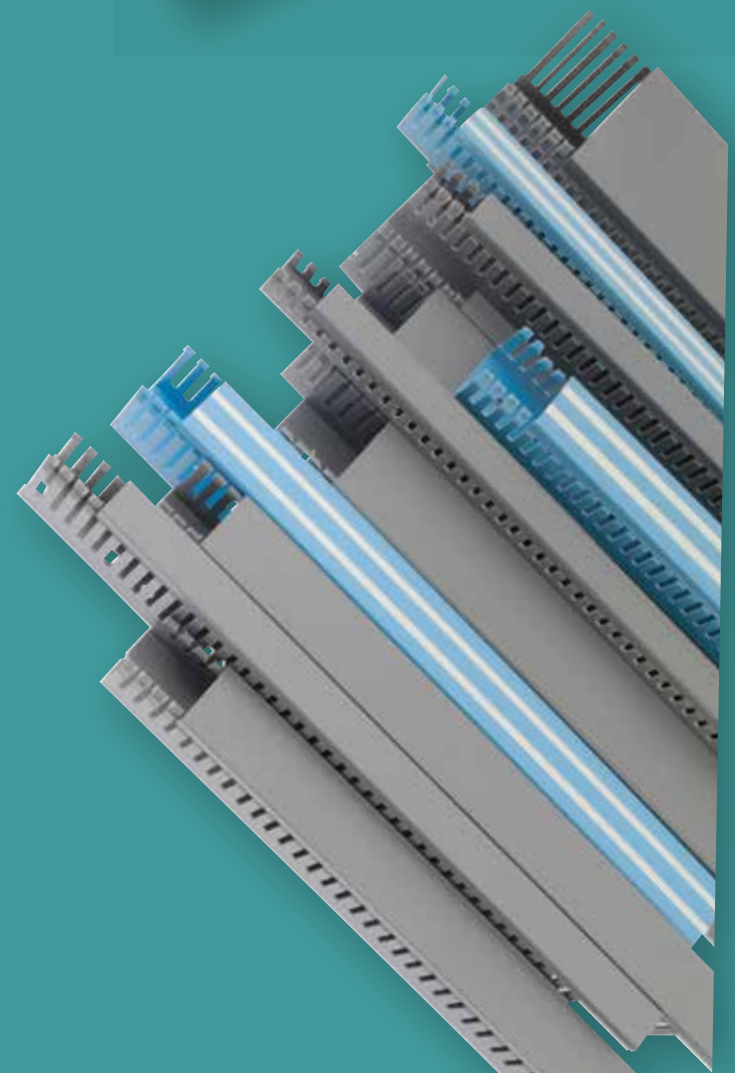
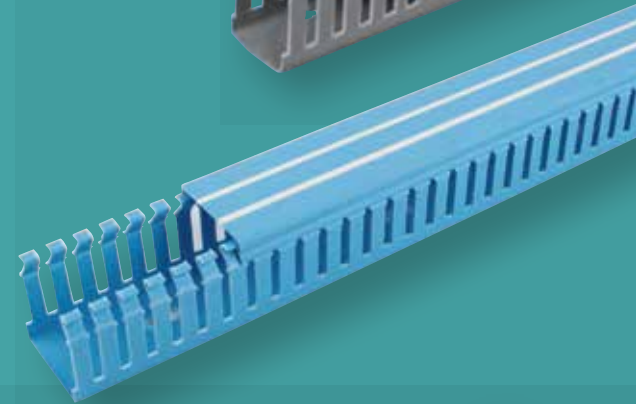
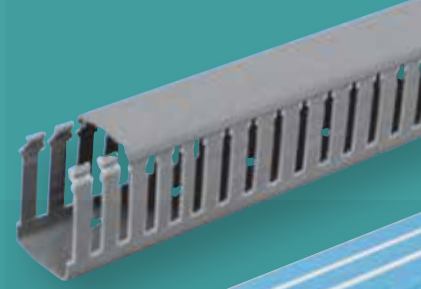

halogen free kablo kanallari
halogen free delikli kanallar

halogen free kablo kanallari

halogen free delikli kanallar

LED
İÇİN ÖZEL
13x12,5mm

YENİ

Kendinden Yapışkanlı
Self-AdhesiveKendinden Kapaklı
Intrinsic CoverKendinden Yapışkanlı
Self-Adhesive

| Kod | Açıklama / Stok Cinsi | Amb. (Kutu) | Amb. Birimi | FİYAT |
|---|--|-------------|-------------|--------|
| CANALEX SERİSİ TSE'Lİ KAPALI TİP KABLO KANALLARI (KUTULU) | | | | |
| IP40 | | | | |
| 001 156 012012 20 00 | 12X12 MM KABLO KANALI (CANALEX) | 250 | mt. | 0,755 |
| 001 156 015010 20 00 | 15X10 MM KABLO KANALI (CANALEX) | 250 | mt. | 0,792 |
| 001 156 016016 20 00 | 16X16 MM KABLO KANALI (CANALEX) | 250 | mt. | 1,024 |
| 001 156 020015 20 00 | 20X15 MM KABLO KANALI (CANALEX) | | mt. | 1,247 |
| 001 156 025016 20 00 | 25X16 MM KABLO KANALI (CANALEX) | 150 | mt. | 1,494 |
| 001 156 025025 20 00 | 25X25 MM KABLO KANALI (CANALEX) | 100 | mt. | 2,120 |
| 001 156 040016 20 00 | 40X16 MM KABLO KANALI (CANALEX) | 100 | mt. | 2,227 |
| 001 156 040025 20 00 | 40X25 MM KABLO KANALI (CANALEX) | 80 | mt. | 3,002 |
| 001 156 040040 20 00 | 40X40 MM KABLO KANALI (CANALEX) | 50 | mt. | 3,489 |
| 001 156 060040 20 00 | 60X40 MM KABLO KANALI (CANALEX) | 40 | mt. | 4,920 |
| 001 156 060060 20 00 | 60X60 MM KABLO KANALI (CANALEX) | 32 | mt. | 7,797 |
| 001 156 080040 20 00 | 80X40 MM KABLO KANALI (CANALEX) | 30 | mt. | 7,506 |
| 001 156 080060 20 00 | 80X60 MM KABLO KANALI (CANALEX) | 24 | mt. | 8,655 |
| 001 156 100040 20 00 | 100X40 MM KABLO KANALI (CANALEX) | 24 | mt. | 9,096 |
| 001 156 100060 20 00 | 100X60 MM KABLO KANALI (CANALEX) | 20 | mt. | 11,737 |
| CANALEX SERİSİ TSE'Lİ KAPALI TİP KABLO KANALLARI (YAPIŞKAN BANTLI) | | | | |
| 001 157 012012 20 00 | 12X12 MM KABLO KANALI CANALEX (YAPIŞKAN BANTLI) | 250 | mt. | 0,889 |
| 001 157 015010 20 00 | 15X10 MM KABLO KANALI CANALEX (YAPIŞKAN BANTLI) | 230 | mt. | 1,027 |
| 001 157 016016 20 00 | 16X16 MM KABLO KANALI CANALEX (YAPIŞKAN BANTLI) | 230 | mt. | 1,229 |
| 001 157 020015 20 00 | 20X15 MM KABLO KANALI CANALEX (YAPIŞKAN BANTLI) | | mt. | 1,734 |
| 001 157 025016 20 00 | 25X16 MM KABLO KANALI CANALEX (YAPIŞKAN BANTLI) | 150 | mt. | 1,817 |
| 001 157 025025 20 00 | 25X25 MM KABLO KANALI CANALEX (YAPIŞKAN BANTLI) | 100 | mt. | 2,449 |
| 001 157 040016 20 00 | 40X16 MM KABLO KANALI CANALEX (YAPIŞKAN BANTLI) | 100 | mt. | 2,907 |
| 001 157 040025 20 00 | 40X25 MM KABLO KANALI CANALEX (YAPIŞKAN BANTLI) | 80 | mt. | 3,708 |
| 001 157 040040 20 00 | 40X40 MM KABLO KANALI CANALEX (YAPIŞKAN BANTLI) | 50 | mt. | 4,340 |
| 001 157 060040 20 00 | 60X40 MM KABLO KANALI CANALEX (YAPIŞKAN BANTLI) | 40 | mt. | 5,923 |
| EKO SERİSİ TSE'Lİ KAPALI TİP KABLO KANALLARI | | | | |
| IP40 | | | | |
| 001 014 010008 20 00 | 10X08 MM KABLO KANALI EKO | 330 | mt. | 0,845 |
| 001 014 012012 20 00 | 12X12 MM KABLO KANALI EKO | 250 | mt. | 0,873 |
| 001 014 015010 20 00 | 15X10 MM KABLO KANALI EKO | 250 | mt. | 0,890 |
| 001 014 015015 20 00 | 15X15 MM KABLO KANALI EKO | 250 | mt. | 1,312 |
| 001 014 016016 20 00 | 16X16 MM KABLO KANALI EKO | 250 | mt. | 1,356 |
| 001 014 020010 20 00 | 20X10 MM KABLO KANALI EKO | 200 | mt. | 1,096 |
| 001 014 025016 20 00 | 25X16 MM KABLO KANALI EKO | 150 | mt. | 1,788 |
| 001 014 025025 20 00 | 25X25 MM KABLO KANALI EKO | 100 | mt. | 2,335 |
| 001 014 025040 20 00 | 25X40 MM KABLO KANALI EKO | 80 | mt. | 5,301 |
| 001 014 930010 20 00 | 30X10 MM KABLO KANALI EKO (BÖLMELİ) | 140 | mt. | 2,217 |
| 001 014 030015 20 00 | 30X15 MM KABLO KANALI EKO | 140 | mt. | 2,193 |
| 001 014 930016 20 00 | 30X16 MM KABLO KANALI EKO (BÖLMELİ) | 140 | mt. | 2,567 |
| 001 014 030016 20 00 | 30X16 MM KABLO KANALI EKO | 140 | mt. | 2,350 |
| 001 014 030025 20 00 | 30X25 MM KABLO KANALI EKO | 80 | mt. | 3,027 |
| 001 014 030030 20 00 | 30X30 MM KABLO KANALI EKO | 80 | mt. | 2,871 |
| 001 014 940016 20 00 | 40X16 MM KABLO KANALI EKO (BÖLMELİ) | 100 | mt. | 3,305 |
| 001 014 040016 20 00 | 40X16 MM KABLO KANALI EKO | 100 | mt. | 2,542 |
| 001 014 040025 20 00 | 40X25 MM KABLO KANALI EKO | 80 | mt. | 3,519 |
| 001 014 040040 20 00 | 40X40 MM KABLO KANALI EKO | 50 | mt. | 4,153 |
| 001 014 040060 20 00 | 40X60 MM KABLO KANALI EKO | 40 | mt. | 8,455 |
| 001 014 960025 20 00 | 60X25 MM KABLO KANALI EKO (BÖLMELİ) | 40 | mt. | 5,814 |
| 001 014 060040 20 00 | 60X40 MM KABLO KANALI EKO | 40 | mt. | 6,011 |
| 001 014 050050 20 00 | 50X50 MM KABLO KANALI EKO | 30 | mt. | 7,315 |
| 001 014 060060 20 00 | 60X60 MM KABLO KANALI EKO | 32 | mt. | 8,134 |
| 001 014 075075 20 00 | 75X75 MM KABLO KANALI EKO | 18 | mt. | 12,080 |
| 001 014 080040 20 00 | 80X40 MM KABLO KANALI EKO | 30 | mt. | 9,200 |
| 001 014 080060 20 00 | 80X60 MM KABLO KANALI EKO | 24 | mt. | 10,083 |
| 001 014 100040 20 00 | 100X40 MM KABLO KANALI EKO (PRİZ SETİ TAKILABİLİR) | 24 | mt. | 10,353 |
| 001 014 100037 20 00 | 100X37 MM KABLO KANALI İÇTEN KAPAKLI KANAL EKO FOLYOLU (PRİZ SETİ TAKILABİLİR) | 30 | mt. | 11,612 |
| 001 014 100050 20 00 | 100X50 MM KABLO KANALI İÇTEN KAPAKLI KANAL EKO FOLYOLU (PRİZ SETİ TAKILABİLİR) | 20 | mt. | 11,961 |
| 001 014 100060 20 00 | 100X60 MM KABLO KANALI EKO (PRİZ SETİ TAKILABİLİR) | 20 | mt. | 12,522 |
| 001 014 120060 20 00 | 120X60 MM KABLO KANALI EKO | 16 | mt. | 18,994 |
| 001 014 100100 20 00 | 100X100 MM KABLO KANALI EKO | 20 | mt. | 23,901 |
| EKO SERİSİ KAPALI TİP KABLO KANALLARI (YAPIŞKAN BANTLI) | | | | |
| IP40 | | | | |
| 001 004 009005 20 00 | 9X5 MM KABLO KANALI KEN.KAPAKLI | 500 | mt. | 0,939 |
| 001 004 010007 20 44 | 9,5X7 MM KABLO KANALI ŞEFFAF KANAL | 500 | mt. | 1,150 |
| 001 004 013012 20 44 | 13X12,5 MM KABLO KANALI ŞEFFAF KANAL | 300 | mt. | 2,753 |
| 001 004 012007 20 00 | 12X7,5 MM KABLO KANALI KENDİNDEN KAPAKLI | 350 | mt. | 1,039 |
| 001 004 013012 20 00 | 13X12,5 MM KABLO KANALI KENDİNDEN KAPAKLI | 300 | mt. | 1,710 |
| 001 004 010008 20 00 | 10X8 MM KABLO KANALI EKO (YAPIŞKAN BANTLI) | 330 | mt. | 0,852 |
| 001 004 010010 20 00 | 10X10 MM KABLO KANALI EKO KENDİNDEN KAPAKLI (YAPIŞKAN BANTLI) | 320 | mt. | 0,954 |
| 001 004 012012 20 00 | 12X12 MM KABLO KANALI EKO (YAPIŞKAN BANTLI) | 250 | mt. | 1,036 |
| 001 004 015010 20 00 | 15X10 MM KABLO KANALI EKO (YAPIŞKAN BANTLI) | 230 | mt. | 1,062 |
| 001 004 016016 20 00 | 16X16 MM KABLO KANALI EKO (YAPIŞKAN BANTLI) | 230 | mt. | 1,541 |
| 001 004 020010 20 00 | 20X10 MM KABLO KANALI EKO (YAPIŞKAN BANTLI) | 180 | mt. | 1,302 |
| 001 004 025016 20 00 | 25X16 MM KABLO KANALI EKO (YAPIŞKAN BANTLI) | 150 | mt. | 2,142 |
| 001 004 025025 20 00 | 25X25 MM KABLO KANALI EKO (YAPIŞKAN BANTLI) | 100 | mt. | 2,645 |
| 001 004 025040 20 00 | 25X40 MM KABLO KANALI EKO (YAPIŞKAN BANTLI) | 80 | mt. | 4,672 |
| 001 004 930010 20 00 | 30X10 MM KABLO KANALI EKO (YAPIŞKAN BANTLI) (BÖLMELİ) | 140 | mt. | 2,102 |
| 001 004 030016 20 00 | 30X16 MM KABLO KANALI EKO (YAPIŞKAN BANTLI) | 140 | mt. | 2,362 |
| 001 004 030025 20 00 | 30X25 MM KABLO KANALI EKO (YAPIŞKAN BANTLI) | 80 | mt. | 3,025 |
| 001 004 040016 20 00 | 40X16 MM KABLO KANALI EKO (YAPIŞKAN BANTLI) | 100 | mt. | 3,309 |
| 001 004 040025 20 00 | 40X25 MM KABLO KANALI EKO (YAPIŞKAN BANTLI) | 80 | mt. | 4,210 |
| 001 004 040040 20 00 | 40X40 MM KABLO KANALI EKO (YAPIŞKAN BANTLI) | 50 | mt. | 4,841 |
| 001 004 060040 20 00 | 60X40 MM KABLO KANALI EKO (YAPIŞKAN BANTLI) | 40 | mt. | 7,360 |
| 001 004 060015 20 17 | 60X15 MM KABLO KANALI BALIK SIRTİ (YAPIŞKAN BANTLI) | 80 | mt. | 6,254 |
| 001 004 075018 20 17 | 75X18 MM KABLO KANALI BALIK SIRTİ (YAPIŞKAN BANTLI) | 60 | mt. | 9,508 |
| 001 004 090020 20 17 | 90X20 MM KABLO KANALI BALIK SIRTİ (YAPIŞKAN BANTLI) | 40 | mt. | 12,168 |

| Kod | Açıklama / Stok Cinsi | Amb. (Kutu) | Amb. Birimi | FİYAT |
|---|---|-------------|-------------|--------|
| H.FREE MEKSPUS SERİSİ KAPALI TİP KABLO KANALLARI | | | | |
| | | | | |
| 001 060 100050 20 00 | 100X50 MM KABLO KANALI İÇTEN KAPAKLI HALOJEN FREE | 20 | mt. | 48,678 |
| 001 061 100050 20 00 | 100X50 MM KABLO KANALI ARA BÖLME HALOJEN FREE | 150 | mt. | 4,913 |
| 001 039 100050 11 00 | 100X50-37 MM KABLO KANALI İÇ KÖŞE(HAREKETLİ) HALOJEN FREE | 12 | ad. | 6,677 |
| 001 040 100050 11 00 | 100X50 MM KABLO KANALI DIŞ KÖŞE(HAREKETLİ) HALOJEN FREE | 10 | ad. | 8,145 |
| 001 041 100050 11 00 | 100X50 MM KABLO KANALI T PARÇASI HALOJEN FREE | 8 | ad. | 7,298 |
| 001 042 100050 11 00 | 100X50 MM KABLO KANALI 90 L KÖŞE HALOJEN FREE | 8 | ad. | 7,041 |
| 001 043 100050 11 00 | 100X50 MM KABLO KANALI EK PARÇA(ÜÇLÜ SET) HALOJEN FREE | 100 | ad. | 1,450 |
| 001 044 100050 11 00 | 100X50 MM KABLO KANALI UÇ TAPA HALOJEN FREE | 40 | ad. | 2,960 |
| 001 047 100001 11 00 | PMS(100X37/50)(45X45)(1LÜ) HALOJEN FREE | 20 | ad. | 5,120 |
| 001 047 100002 11 00 | PMS(100X37/50)(45X45)(2LÜ) HALOJEN FREE | 14 | ad. | 6,559 |
| 001 047 100003 11 00 | PMS(100X37/50)(45X45)(3LÜ) HALOJEN FREE | 12 | ad. | 8,709 |
| H.FREE SERİSİ KAPALI TİP KABLO KANALLARI | | | | |
| | | | | |
| 001 060 025016 20 00 | 25X16 MM KABLO KANALI HALOJEN FREE | 100 | mt. | 8,500 |
| 001 060 025025 20 00 | 25X25 MM KABLO KANALI HALOJEN FREE | 100 | mt. | 8,800 |
| 001 060 040025 20 00 | 40X25 MM KABLO KANALI HALOJEN FREE | 80 | mt. | 9,977 |
| 001 060 040040 20 00 | 40X40 MM KABLO KANALI HALOJEN FREE | 50 | mt. | 12,688 |
| MEKS SERİSİ TSE'Lİ KAPALI TİP KABLO KANALLARI | | | | |
| | | | | |
| 001 002 015015 20 00 | 15X15 MM KABLO KANALI MEKS | 250 | mt. | 1,518 |
| 001 002 016016 20 00 | 16X16 MM KABLO KANALI MEKS | 250 | mt. | 1,618 |
| 001 002 025016 20 00 | 25X16 MM KABLO KANALI MEKS | 150 | mt. | 2,162 |
| 001 002 025025 20 00 | 25X25 MM KABLO KANALI MEKS | 100 | mt. | 2,859 |
| 001 002 030015 20 00 | 30X15 MM KABLO KANALI MEKS | 140 | mt. | 3,036 |
| 001 002 030030 20 00 | 30X30 MM KABLO KANALI MEKS | 80 | mt. | 3,201 |
| 001 002 040017 20 00 | 40X17 MM KABLO KANALI TAM KAPAKLI MEKS | 100 | mt. | 4,025 |
| 001 002 040025 20 00 | 40X25 MM KABLO KANALI MEKS | 80 | mt. | 3,979 |
| 001 002 040040 20 00 | 40X40 MM KABLO KANALI MEKS | 50 | mt. | 5,106 |
| 001 002 960025 20 00 | 60X25 MM KABLO KANALI MEKS (BÖLMELİ) | 40 | mt. | 6,482 |
| 001 002 060040 20 00 | 60X40 MM KABLO KANALI MEKS | 40 | mt. | 6,556 |
| 001 002 975022 20 00 | 75X22 MM KABLO KANALI MEKS (BÖLMELİ) | 50 | mt. | 10,312 |
| 001 002 080060 20 00 | 80X60 MM KABLO KANALI MEKS | 24 | mt. | 10,600 |
| 001 002 100036 20 00 | 100X36 MM KABLO KANALI MEKS | 30 | mt. | 14,795 |
| 001 002 100040 20 00 | 100X40 MM KABLO KANALI MEKS | 24 | mt. | 11,951 |
| 001 002 100048 20 00 | 100X48 MM KABLO KANALI MEKS | 24 | mt. | 16,629 |
| 001 002 120070 20 00 | 120X70 MM KABLO KANALI (İÇTEN KAPAKLI)(AKSESUARISIZ) | 16 | mt. | 20,560 |
| 001 002 170070 20 00 | 170X50 MM KABLO KANALI (İÇTEN KAPAKLI)(AKSESUARISIZ) | 12 | mt. | 30,464 |
| 001 002 250070 20 00 | 250X70 MM KABLO KANALI (İÇTEN KAPAKLI)(AKSESUARISIZ) | 8 | mt. | 47,504 |
| 001 002 100060 20 00 | 100X60 MM KABLO KANALI MEKS | 20 | mt. | 16,516 |
| 001 002 120060 20 00 | 120X60 MM KABLO KANALI MEKS | 16 | mt. | 20,516 |
| MEKS SERİSİ KAPALI TİP KABLO KANALLARI | | | | |
| | | | | |
| 001 002 100037 20 00 | 100X37 MM KABLO KANALI MEKS (İÇTEN KAPAKLI)(FOLYOLU) | 30 | mt. | 14,505 |
| 001 002 100041 20 00 | 100X41 MM KABLO KANALI MEKS (İÇTEN KAPAKLI)(FOLYOLU) | 24 | mt. | 14,666 |
| 001 002 100050 20 00 | 100X50 MM KABLO KANALI MEKS (İÇTEN KAPAKLI)(FOLYOLU) | 20 | mt. | 16,449 |
| MEKSPUS SERİSİ KAPALI TİP KABLO KANALLARI | | | | |
| | | | | |
| 001 003 040025 20 00 | 40X25 MM KABLO KANALI (İÇTEN KAPAKLI) | 80 | mt. | 5,182 |
| 001 003 100037 20 00 | 100X37 MM KABLO KANALI (İÇTEN KAPAKLI) | 30 | mt. | 13,910 |
| 001 003 100041 20 00 | 100X41 MM KABLO KANALI (İÇTEN KAPAKLI) | 24 | mt. | 14,280 |
| 001 003 100050 20 00 | 100X50 MM KABLO KANALI (İÇTEN KAPAKLI)(2MM KABLO KANALI EK KALIN) | 20 | mt. | 17,954 |
| 001 003 120070 20 00 | 120X70 MM KABLO KANALI (İÇTEN KAPAKLI)(AKSESUARISIZ) | 16 | mt. | 21,986 |
| 001 003 170070 20 00 | 170X50 MM KABLO KANALI (İÇTEN KAPAKLI)(AKSESUARISIZ) | 8 | mt. | 36,470 |
| 001 003 250070 20 00 | 250X70 MM KABLO KANALI (İÇTEN KAPAKLI)(AKSESUARISIZ) | 8 | mt. | 53,377 |
| 001 006 100050 20 00 | 100X50 MM KABLO KANALI (İÇTEN KAPAKLI)(KPMS SERİSİ) | 20 | mt. | 20,441 |
| 001 888 100050 00 00 | 100X50 MM KABLO KANALI KPMS MONTAJ APARATI | 50 | mt. | 1,980 |
| MEKS SERİSİ KLİMA KANALI VE AKSESUARLARI | | | | |
| | | | | |
| 001 002 075060 20 00 | 75X60 MM KLİMA KANALI | 30 | mt. | 10,000 |
| 001 050 030002 00 00 | KLİMA KANALI KABLO TUTUCUSU | 60 | ad. | 1,034 |
| 001 043 075060 00 00 | KLİMA KANALI EK PARÇASI | 40 | ad. | 1,063 |
| 001 039 075060 00 00 | KLİMA KANALI İÇ KÖŞE | 24 | ad. | 1,906 |
| 001 040 075060 00 00 | KLİMA KANALI DIŞ KÖŞE | 24 | ad. | 2,022 |
| 001 042 075060 00 00 | KLİMA KANALI L KÖŞE | 18 | ad. | 2,218 |
| 001 050 030001 00 00 | KLİMA KANALI DUVAR GEÇİŞİ | 60 | ad. | 1,184 |
| 001 044 075060 01 00 | KLİMA KANALI İÇ SONLAMA | 30 | ad. | 1,727 |
| 001 044 075060 02 00 | KLİMA KANALI DIŞ SONLAMA | 18 | ad. | 1,768 |
| TAVAN KÖŞE KANALI | | | | |
| | | | | |
| 001 002 023023 20 00 | 23X23 MM TAVAN KÖŞE KANALI | 120 | mt. | 2,993 |
| FUGALI SÜPÜRGELİK | | | | |
| 001 010 000200 20 00 | 50'LİK FUGALI SÜPÜRGELİK | 60 | mt. | 2,129 |
| TEZGAH SÜPÜRGELİĞİ | | | | |
| 001 011 000100 00 00 | 25'LİK TEZGAH SÜPÜRGELİĞİ 100CM | 60 | mt. | 3,975 |
| BALIK SIRTI ZEMİN KANALLARI | | | | |
| 001 002 060015 20 00 | 60X15 MM BALIK SIRTI KANAL (ZEMİN İÇİN) | 80 | mt. | 5,204 |
| 001 042 060015 00 17 | 60X15 MM BALIK SIRTI KANAL L KÖŞE | 24 | ad. | 1,150 |
| 001 043 060015 00 17 | 60X15 MM BALIK SIRTI KANAL EK PARÇASI | 50 | ad. | 0,731 |
| 001 044 060015 00 17 | 60X15 MM BALIK SIRTI KANAL SONLAMA KAPAĞI | 50 | ad. | 0,692 |
| 001 041 060015 00 17 | 60X15 MM BALIK SIRTI KANAL T KÖŞE | 10 | ad. | 2,287 |
| 001 002 075018 20 00 | 75X18 MM BALIK SIRTI KANAL (ZEMİN İÇİN) | 60 | mt. | 8,925 |
| 001 042 075018 00 17 | 75X18 MM BALIK SIRTI KANAL L KÖŞE | 15 | ad. | 1,093 |
| 001 043 075018 00 17 | 75X18 MM BALIK SIRTI KANAL EK PARÇASI | 50 | ad. | 0,546 |
| 001 044 075018 00 17 | 75X18 MM BALIK SIRTI KANAL SONLAMA KAPAĞI | 50 | ad. | 0,578 |
| 001 041 075018 00 17 | 75X18 MM BALIK SIRTI KANAL T KÖŞE | 8 | ad. | 2,069 |
| 001 002 090020 20 17 | 90X20 MM BALIK SIRTI KANAL (ZEMİN İÇİN) | 40 | mt. | 11,689 |
| 001 042 090020 00 17 | 90X20 MM BALIK SIRTI KANAL L KÖŞE | 20 | ad. | 1,354 |
| 001 043 090020 00 17 | 90X20 MM BALIK SIRTI KANAL EK PARÇASI | 50 | ad. | 0,601 |
| 001 044 090020 00 17 | 90X20 MM BALIK SIRTI KANAL SONLAMA KAPAĞI | 50 | ad. | 0,601 |
| 001 041 090020 00 17 | 90X20 MM BALIK SIRTI KANAL T KÖŞE | 12 | ad. | 2,408 |



| Kod | Açıklama / Stok Cinsi | Amb. (Kutu) | Amb. Birimi | FİYAT |
|--------------------------------------|-----------------------|----------------|----------------|-------|
| 12X12 KANAL AKSESUARLARI IP40 | | | | |
| 001 039 012012 00 00 | 12X12 MM İÇ KÖŞE | 60 | ad. | 0,674 |
| 001 040 012012 00 00 | 12X12 MM DIŞ KÖŞE | 60 | ad. | 0,674 |
| 001 041 012012 00 00 | 12X12 MM T KÖŞE | 60 | ad. | 0,674 |
| 001 042 012012 00 00 | 12X12 MM 90 L KÖŞE | 60 | ad. | 0,674 |
| 001 044 012012 00 00 | 12X12 MM UÇ TAPA | 100 | ad. | 0,674 |
| 001 043 012012 00 00 | 12X12 MM EK PARÇASI | 100 | ad. | 0,674 |
| 15X10 KANAL AKSESUARLARI IP40 | | | | |
| 001 039 015010 00 00 | 15X10 MM İÇ KÖŞE | 60 | ad. | 0,686 |
| 001 040 015010 00 00 | 15X10 MM DIŞ KÖŞE | 60 | ad. | 0,686 |
| 001 041 015010 00 00 | 15X10 MM T KÖŞE | 60 | ad. | 0,686 |
| 001 042 015010 00 00 | 15X10 MM 90 L KÖŞE | 60 | ad. | 0,686 |
| 001 044 015010 00 00 | 15X10 MM UÇ TAPA | 100 | ad. | 0,686 |
| 001 043 016016 00 00 | 15X10 MM EK PARÇASI | 100 | ad. | 0,686 |
| 20X10 KANAL AKSESUARLARI IP40 | | | | |
| 001 039 020010 00 00 | 20X10 MM İÇ KÖŞE | 60 | ad. | 0,725 |
| 001 040 020010 00 00 | 20X10 MM DIŞ KÖŞE | 60 | ad. | 0,725 |
| 001 041 020010 00 00 | 20X10 MM T KÖŞE | 30 | ad. | 0,725 |
| 001 042 020010 00 00 | 20X10 MM 90 L KÖŞE | 50 | ad. | 0,725 |
| 001 044 020010 00 00 | 20X10 MM UÇ TAPA | 100 | ad. | 0,725 |
| 001 043 020010 00 00 | 20X10 MM EK PARÇASI | 100 | ad. | 0,725 |
| 16X16 KANAL AKSESUARLARI IP40 | | | | |
| 001 039 016016 00 00 | 16X16 MM İÇ KÖŞE | 60 | ad. | 0,699 |
| 001 040 016016 00 00 | 16X16 MM DIŞ KÖŞE | 60 | ad. | 0,699 |
| 001 041 016016 00 00 | 16X16 MM T KÖŞE | 60 | ad. | 1,030 |
| 001 042 016016 00 00 | 16X16 MM 90 L KÖŞE | 60 | ad. | 0,699 |
| 001 044 016016 00 00 | 16X16 MM UÇ TAPA | 100 | ad. | 0,699 |
| 001 043 016016 00 00 | 16X16 MM EK PARÇASI | 100 | ad. | 0,725 |
| 25X16 KANAL AKSESUARLARI IP40 | | | | |
| 001 039 025016 00 00 | 25X16 MM İÇ KÖŞE | 40 | ad. | 0,762 |
| 001 040 025016 00 00 | 25X16 MM DIŞ KÖŞE | 40 | ad. | 0,780 |
| 001 041 025016 00 00 | 25X16 MM T KÖŞE | 30 | ad. | 1,131 |
| 001 042 025016 00 00 | 25X16 MM 90 L KÖŞE | 50 | ad. | 0,847 |
| 001 044 025016 00 00 | 25X16 MM UÇ TAPA | 100 | ad. | 0,762 |
| 001 043 025016 00 00 | 25X16 MM EK PARÇA | 100 | ad. | 0,762 |
| 001 047 017421 00 00 | 25X16 MM PMK (45X45) | 6 | ad. | 8,958 |
| 25X25 KANAL AKSESUARLARI IP40 | | | | |
| 001 039 025025 00 00 | 25X25 MM İÇ KÖŞE | 40 | ad. | 0,801 |
| 001 040 025025 00 00 | 25X25 MM DIŞ KÖŞE | 40 | ad. | 0,801 |
| 001 041 025025 00 00 | 25X25 MM T PARÇASI | 24 | ad. | 1,208 |
| 001 042 025025 00 00 | 25X25 MM 90 L KÖŞE | 40 | ad. | 0,801 |
| 001 044 025025 00 00 | 25X25 MM UÇ TAPA | 100 | ad. | 0,801 |
| 001 043 025025 00 00 | 25X25 MM EK PARÇA | 50 | ad. | 0,801 |
| 001 047 017421 00 00 | 25X25 MM PMK (45X45) | 6 | ad. | 8,958 |
| 30X10 KANAL AKSESUARLARI IP40 | | | | |
| 001 039 030010 00 00 | 30X10 MM İÇ KÖŞE | 50 | ad. | 1,429 |
| 001 040 030010 00 00 | 30X10 MM DIŞ KÖŞE | 50 | ad. | 1,429 |
| 001 041 030010 00 00 | 30X10 MM T PARÇASI | 50 | ad. | 1,099 |
| 001 042 030010 00 00 | 30X10 MM 90 L KÖŞE | 50 | ad. | 1,200 |
| 001 044 030010 00 00 | 30X10 MM UÇ TAPA | 100 | ad. | 0,979 |
| 001 043 030010 00 00 | 30X10 MM EK PARÇA | 100 | ad. | 1,016 |
| 30X16 KANAL AKSESUARLARI IP40 | | | | |
| 001 039 030016 00 00 | 30X16 MM İÇ KÖŞE | 35 | ad. | 1,487 |
| 001 040 030016 00 00 | 30X16 MM DIŞ KÖŞE | 48 | ad. | 1,487 |
| 001 041 030016 00 00 | 30X16 MM T PARÇASI | 40 | ad. | 1,143 |
| 001 042 030016 00 00 | 30X16 MM 90 L KÖŞE | 50 | ad. | 1,200 |
| 001 044 030016 00 00 | 30X16 MM UÇ TAPA | 100 | ad. | 1,016 |
| 001 043 030016 00 00 | 30X16 MM EK PARÇA | 100 | ad. | 1,016 |
| 30X25 KANAL AKSESUARLARI IP40 | | | | |
| 001 039 030025 00 00 | 30X25 MM İÇ KÖŞE | 30 | ad. | 1,626 |
| 001 040 030025 00 00 | 30X25 MM DIŞ KÖŞE | 32 | ad. | 1,626 |
| 001 041 030025 00 00 | 30X25 MM T PARÇASI | 24 | ad. | 1,233 |
| 001 042 030025 00 00 | 30X25 MM 90 L KÖŞE | 30 | ad. | 1,264 |
| 001 044 030025 00 00 | 30X25 MM UÇ TAPA | 100 | ad. | 1,081 |
| 001 043 030025 00 00 | 30X25 MM EK PARÇA | 100 | ad. | 1,016 |
| 40X16 KANAL AKSESUARLARI IP40 | | | | |
| 001 039 040016 00 00 | 40X16 MM İÇ KÖŞE | 32 | ad. | 1,474 |
| 001 040 040016 00 00 | 40X16 MM DIŞ KÖŞE | 30 | ad. | 1,474 |
| 001 041 040016 00 00 | 40X16 MM T KÖŞE | 24 | ad. | 1,208 |
| 001 042 040016 00 00 | 40X16 MM 90 L KÖŞE | 34 | ad. | 1,208 |
| 001 044 040016 00 00 | 40X16 MM UÇ TAPA | 25 | ad. | 1,335 |
| 001 043 040016 00 00 | 40X16 MM EK PARÇASI | 100 | ad. | 1,208 |
| 001 047 017421 00 00 | 40X16 MM PMK (45X45) | 6 | ad. | 8,958 |
| 40X25 KANAL AKSESUARLARI IP40 | | | | |
| 001 039 040025 00 00 | 40X25 MM İÇ KÖŞE | 24 | ad. | 1,589 |
| 001 040 040025 00 00 | 40X25 MM DIŞ KÖŞE | 30 | ad. | 1,589 |
| 001 041 040025 00 00 | 40X25 MM T KÖŞE | 18 | ad. | 1,271 |
| 001 042 040025 00 00 | 40X25 MM 90 L KÖŞE | 24 | ad. | 1,271 |
| 001 044 040025 00 00 | 40X25 MM UÇ TAPA | 25 | ad. | 1,335 |
| 001 043 040016 00 00 | 40X25 MM EK PARÇASI | 70 | ad. | 1,208 |
| 001 047 017421 00 00 | 40X25 MM PMK (45X45) | 6 | ad. | 8,958 |

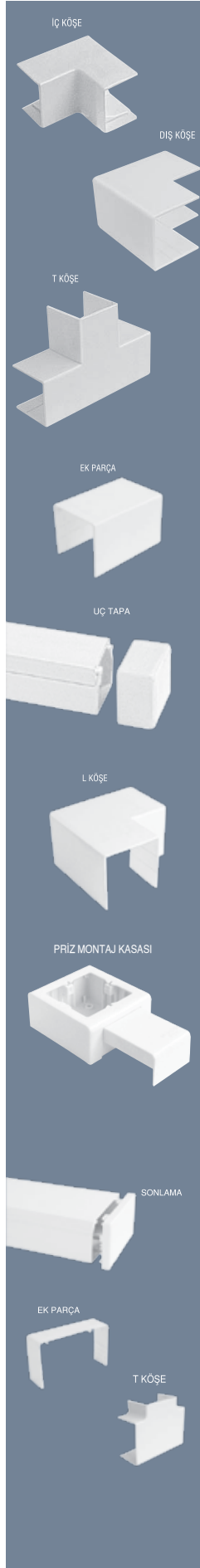

| Kod | Açıklama / Stok Cinsi | Amb. (Kutu) | Amb. Birimi | FİYAT |
|---------------------------------------|-----------------------------------|----------------|----------------|-------|
| 40X40 KANAL AKSESUARLARI IP40 | | | | |
| 001 039 040040 00 00 | 40X40 MM İÇ KÖŞE | 18 | ad. | 1,335 |
| 001 040 040040 00 00 | 40X40 MM DIŞ KÖŞE | 10 | ad. | 1,855 |
| 001 041 040040 00 00 | 40X40 MM T PARÇASI | 48 | ad. | 1,499 |
| 001 042 040040 00 00 | 40X40 MM 90 L KÖŞE | 60 | ad. | 1,335 |
| 001 044 040040 00 00 | 40X40 MM UÇ TAPA | 25 | ad. | 1,335 |
| 001 043 040016 00 00 | 40X40 MM EK PARÇA | 100 | ad. | 1,208 |
| 001 047 017421 00 00 | 40X40 MM PMK (45X45) | 6 | ad. | 8,958 |
| 75X22 KANAL AKSESUARLARI IP40 | | | | |
| 001 039 075022 00 00 | 75X22 MM İÇ KÖŞE | 20 | ad. | 1,569 |
| 001 040 075022 00 00 | 75X22 MM DIŞ KÖŞE | 20 | ad. | 1,569 |
| 001 044 075022 01 00 | 75X22 MM SAĞ SONLAMA | 30 | ad. | 1,569 |
| 001 044 075022 02 00 | 75X22 MM SOL SONLAMA | 20 | ad. | 1,569 |
| 001 043 075022 00 00 | 75X22 MM EK PARÇASI | 100 | ad. | 1,569 |
| 60X25 KANAL AKSESUARLARI IP40 | | | | |
| 001 039 060025 00 00 | 60X25 MM İÇ KÖŞE | 48 | ad. | 3,161 |
| 001 040 060025 00 00 | 60X25 MM DIŞ KÖŞE | 72 | ad. | 3,161 |
| 001 041 060025 00 00 | 60X25 MM T PARÇASI | 40 | ad. | 3,161 |
| 001 042 060025 00 00 | 60X25 MM 90 L KÖŞE | 60 | ad. | 3,161 |
| 001 044 060025 00 00 | 60X25 MM UÇ TAPA | 50 | ad. | 1,411 |
| 001 043 060025 00 00 | 60X25 MM EK PARÇA | 60 | ad. | 1,099 |
| 60X40 KANAL AKSESUARLARI IP40 | | | | |
| 001 039 060040 00 00 | 60X40 MM İÇ KÖŞE | 26 | ad. | 3,161 |
| 001 040 060040 00 00 | 60X40 MM DIŞ KÖŞE | 32 | ad. | 3,161 |
| 001 041 060040 00 00 | 60X40 MM T PARÇASI | 32 | ad. | 3,161 |
| 001 042 060040 00 00 | 60X40 MM 90 L KÖŞE | 40 | ad. | 3,161 |
| 001 044 060040 00 00 | 60X40 MM UÇ TAPA | 50 | ad. | 1,347 |
| 001 043 060040 00 00 | 60X40 MM EK PARÇA | 40 | ad. | 1,099 |
| 60X60 KANAL AKSESUARLARI IP40 | | | | |
| 001 039 060060 01 00 | 60X60 MM İÇ KÖŞE (HAREKETLİ) | 16 | ad. | 3,176 |
| 001 040 060060 01 00 | 60X60 MM DIŞ KÖŞE (HAREKETLİ) | 16 | ad. | 3,430 |
| 001 041 060060 00 00 | 60X60 MM T PARÇASI | 20 | ad. | 3,176 |
| 001 042 060060 00 00 | 60X60 MM 90 L KÖŞE | 24 | ad. | 3,176 |
| 001 044 060060 00 00 | 60X60 MM UÇ TAPA | 30 | ad. | 1,279 |
| 001 043 060060 00 00 | 60X60 MM EK PARÇA | 25 | ad. | 1,099 |
| 80X40 KANAL AKSESUARLARI IP40 | | | | |
| 001 039 080040 00 00 | 80X40 MM İÇ KÖŞE | 18 | ad. | 3,586 |
| 001 040 080040 00 00 | 80X40 MM DIŞ KÖŞE | 8 | ad. | 3,586 |
| 001 041 080040 00 00 | 80X40 MM T PARÇASI | 12 | ad. | 3,586 |
| 001 042 080040 00 00 | 80X40 MM 90 L KÖŞE | 16 | ad. | 3,719 |
| 001 044 080040 00 00 | 80X40 MM UÇ TAPA | 60 | ad. | 1,395 |
| 001 043 080040 00 00 | 80X40 MM EK PARÇA | 100 | ad. | 1,328 |
| 80X60 KANAL AKSESUARLARI IP40 | | | | |
| 001 039 080060 00 00 | 80X60 MM İÇ KÖŞE | 12 | ad. | 3,698 |
| 001 040 080060 00 00 | 80X60 MM DIŞ KÖŞE | 8 | ad. | 3,698 |
| 001 041 080060 00 00 | 80X60 MM T PARÇASI | 10 | ad. | 4,052 |
| 001 042 080060 00 00 | 80X60 MM 90 L KÖŞE | 12 | ad. | 3,698 |
| 001 044 080060 00 00 | 80X60 MM UÇ TAPA | 48 | ad. | 1,528 |
| 001 043 080060 00 00 | 80X60 MM EK PARÇA | 80 | ad. | 1,674 |
| 100X36 KANAL AKSESUARLARI IP40 | | | | |
| 001 039 100036 00 00 | 100X36 MM İÇ KÖŞE (SABİT) | 8 | ad. | 4,052 |
| 001 040 100036 00 00 | 100X36 MM DIŞ KÖŞE (SABİT) | 8 | ad. | 4,052 |
| 001 039 100036 01 00 | 100X36 MM İÇ KÖŞE (HAREKETLİ) | 8 | ad. | 4,052 |
| 001 040 100036 01 00 | 100X36 MM DIŞ KÖŞE (HAREKETLİ) | 10 | ad. | 4,052 |
| 001 041 100036 00 00 | 100X36 MM T PARÇASI | 12 | ad. | 4,052 |
| 001 042 100036 00 00 | 100X36 MM 90 L KÖŞE | 12 | ad. | 4,052 |
| 001 044 100036 00 00 | 100X36 MM UÇ TAPA | 200 | ad. | 1,915 |
| 001 043 100036 00 00 | 100X36 MM EK PARÇA | 100 | ad. | 1,265 |
| 001 050 030004 00 00 | 100X36 MM KANAL KİLİTLEME APARATI | 100 | ad. | 0,472 |
| 001 013 100036 20 00 | 100X36 MM ARA BÖLME | 200 | mt. | 2,072 |
| 100X37 KANAL AKSESUARLARI IP40 | | | | |
| 001 039 100037 00 00 | 100X37 MM İÇ KÖŞE (SABİT) | 12 | ad. | 3,919 |
| 001 040 100037 00 00 | 100X37 MM DIŞ KÖŞE (SABİT) | 8 | ad. | 3,919 |
| 001 039 100050 01 00 | 100X37 MM İÇ KÖŞE (HAREKETLİ) | 12 | ad. | 3,919 |
| 001 040 100050 01 00 | 100X37 MM DIŞ KÖŞE (HAREKETLİ) | 10 | ad. | 4,808 |
| 001 041 100037 00 00 | 100X37 MM T PARÇASI | 12 | ad. | 3,919 |
| 001 042 100037 00 00 | 100X37 MM 90 L KÖŞE | 12 | ad. | 3,919 |
| 001 044 100037 00 00 | 100X37 MM UÇ TAPA | 50 | ad. | 1,915 |
| 001 043 100037 00 00 | 100X37 MM EK PARÇA | 100 | ad. | 1,328 |
| 100X40 KANAL AKSESUARLARI IP40 | | | | |
| 001 039 100040 00 00 | 100X40 MM İÇ KÖŞE (SABİT) | 8 | ad. | 4,052 |
| 001 040 100040 00 00 | 100X40 MM DIŞ KÖŞE (SABİT) | 8 | ad. | 4,344 |
| 001 039 100040 01 00 | 100X40 MM İÇ KÖŞE (HAREKETLİ) | 8 | ad. | 4,052 |
| 001 040 100040 01 00 | 100X40 MM DIŞ KÖŞE (HAREKETLİ) | 10 | ad. | 4,052 |
| 001 041 100040 00 00 | 100X40 MM T PARÇASI | 12 | ad. | 4,052 |
| 001 042 100040 00 00 | 100X40 MM 90 L KÖŞE | 12 | ad. | 4,052 |
| 001 044 100040 00 00 | 100X40 MM UÇ TAPA | 20 | ad. | 1,915 |
| 0 | | | | |

| Kod | Açıklama / Stok Cinsi | Amb. (Kutu) | Amb. Birimi | FİYAT |
|-----|-----------------------|-------------|-------------|-------|
|-----|-----------------------|-------------|-------------|-------|

100X48 KANAL AKSESUARLARI

| Kod | Açıklama / Stok Cinsi | Amb. (Kutu) | Amb. Birimi | FİYAT |
|----------------------|-----------------------------------|-------------|-------------|-------|
| 001 039 100048 00 00 | 100X48 MM İÇ KÖŞE (SABİT) | 8 | ad. | 4,503 |
| 001 040 100048 00 00 | 100X48 MM DIŞ KÖŞE (SABİT) | 8 | ad. | 4,503 |
| 001 039 100060 01 00 | 100X48 MM İÇ KÖŞE (HAREKETLİ) | 8 | ad. | 4,489 |
| 001 040 100060 01 00 | 100X48 MM DIŞ KÖŞE (HAREKETLİ) | 10 | ad. | 4,489 |
| 001 041 100048 00 00 | 100X48 MM T PARÇASI | 8 | ad. | 4,489 |
| 001 042 100048 00 00 | 100X48 MM 90 L KÖŞE | 8 | ad. | 4,489 |
| 001 044 100048 00 00 | 100X48 MM UÇ TAPA | 20 | ad. | 1,915 |
| 001 043 100048 00 00 | 100X48 MM EK PARÇA | 100 | ad. | 1,262 |
| 001 050 030004 00 00 | 100X48 MM KANAL KİLİTLEME APARATI | 100 | ad. | 0,472 |
| 001 013 100048 20 00 | 100X48 MM ARA BÖLME | 150 | mt. | 2,046 |

100X60 KANAL AKSESUARLARI

| Kod | Açıklama / Stok Cinsi | Amb. (Kutu) | Amb. Birimi | FİYAT |
|----------------------|-----------------------------------|-------------|-------------|-------|
| 001 039 100060 00 00 | 100X60 MM İÇ KÖŞE (SABİT) | 8 | ad. | 3,985 |
| 001 040 100060 00 00 | 100X60 MM DIŞ KÖŞE (SABİT) | 8 | ad. | 4,649 |
| 001 039 100060 01 00 | 100X60 MM İÇ KÖŞE (HAREKETLİ) | 8 | ad. | 4,489 |
| 001 040 100060 01 00 | 100X60 MM DIŞ KÖŞE (HAREKETLİ) | 10 | ad. | 4,489 |
| 001 041 100060 00 00 | 100X60 MM T PARÇASI | 8 | ad. | 4,144 |
| 001 042 100060 00 00 | 100X60 MM 90 L KÖŞE | 8 | ad. | 4,250 |
| 001 044 100060 00 00 | 100X60 MM UÇ TAPA | 20 | ad. | 1,915 |
| 001 043 100060 00 00 | 100X60 MM EK PARÇA | 100 | ad. | 1,265 |
| 001 050 030004 00 00 | 100X60 MM KANAL KİLİTLEME APARATI | 100 | ad. | 0,472 |
| 001 013 100060 20 00 | 100X60 MM ARA BÖLME | 130 | mt. | 2,564 |

100X50 KANAL AKSESUARLARI

| Kod | Açıklama / Stok Cinsi | Amb. (Kutu) | Amb. Birimi | FİYAT |
|----------------------|--------------------------------|-------------|-------------|-------|
| 001 039 100050 00 00 | 100X50 MM İÇ KÖŞE (SABİT) | 8 | ad. | 3,985 |
| 001 040 100050 00 00 | 100X50 MM DIŞ KÖŞE (SABİT) | 8 | ad. | 3,985 |
| 001 039 100050 01 00 | 100X50 MM İÇ KÖŞE (HAREKETLİ) | 12 | ad. | 4,120 |
| 001 040 100050 01 00 | 100X50 MM DIŞ KÖŞE (HAREKETLİ) | 10 | ad. | 4,808 |
| 001 041 100050 00 00 | 100X50 MM T PARÇASI | 8 | ad. | 4,871 |
| 001 042 100050 00 00 | 100X50 MM 90 L KÖŞE | 8 | ad. | 4,617 |
| 001 044 100050 00 00 | 100X50 MM UÇ TAPA | 40 | ad. | 2,258 |
| 001 043 100050 00 00 | 100X50 MM EK PARÇA | 100 | ad. | 1,594 |
| 001 043 100050 01 00 | 100X50 MM EK PARÇA (3LÜ SET) | 100 | ad. | 1,594 |
| 001 046 195100 00 00 | 100X50 MM KANAL İÇİ KÜP BUAT | 25 | ad. | 2,119 |

100X50 KAİDESİZ KANAL AKSESUARLARI

| Kod | Açıklama / Stok Cinsi | Amb. (Kutu) | Amb. Birimi | FİYAT |
|----------------------|------------------------------|-------------|-------------|-------|
| 001 039 100051 00 00 | 100X50 MM KAİDESİZ İÇ KÖŞE | 8 | ad. | 3,983 |
| 001 040 100051 00 00 | 100X50 MM KAİDESİZ DIŞ KÖŞE | 8 | ad. | 3,985 |
| 001 041 100051 00 00 | 100X50 MM KAİDESİZ T PARÇASI | 8 | ad. | 4,450 |
| 001 042 100051 00 00 | 100X50 MM KAİDESİZ 90 L KÖŞE | 8 | ad. | 4,025 |
| 001 043 100051 00 00 | 100X50 MM KAİDESİZ EK PARÇA | 100 | ad. | 1,260 |
| 001 044 100051 00 00 | 100X50 MM KAİDESİZ UÇ TAPA | 40 | ad. | 1,600 |

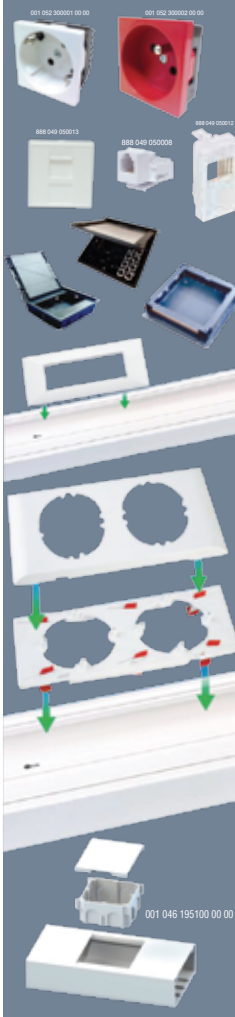

| Kod | Açıklama / Stok Cinsi | Amb. (Kutu) | Amb. Birimi | FİYAT |
|-----|-----------------------|-------------|-------------|-------|
|-----|-----------------------|-------------|-------------|-------|

KANAL İÇİN UPS VE ENERJİ PRİZLERİ (45X45) TSE'LI

| Kod | Açıklama / Stok Cinsi | Amb. (Kutu) | Amb. Birimi | FİYAT |
|----------------------|-------------------------------------|-------------|-------------|----------|
| 001 052 300001 00 00 | 45X45 TOP.P.ÇEKİRDEĞİ ÇÇK.KOR.(45°) | 50 | ad. | 4,125 |
| 001 052 300002 00 00 | 45X45 UPS P.ÇEKİRDEĞİ ÇÇK.KOR.(45°) | 50 | ad. | 4,400 |
| 001 052 200005 00 00 | 45X45 PRİZ BİRLEŞTİRME APARATI | 50 | ad. | 2,167 |
| 888 049 050008 | DATA KONNEKTÖRÜ CAT 5e (RJ65 8) | 1 | ad. | 1,456 \$ |
| 888 049 050032 | DATA KONNEKTÖRÜ CAT 6e (RJ65 8) | 1 | ad. | 2,096 \$ |
| 888 049 050009 | TELEFON KONNEKTÖRÜ (RJ 11/12 6) | 1 | ad. | 1,281 \$ |
| 888 049 050013 | 45X45 DATA PRİZ KAPAĞI | 1 | ad. | 0,792 \$ |
| 888 049 050012 | 45X22,5 DATA PRİZ KAPAĞI | 1 | ad. | 0,652 \$ |

DÖŞEME ALTI PRİZ SİSTEMLERİ

| Kod | Açıklama / Stok Cinsi | Amb. (Kutu) | Amb. Birimi | FİYAT |
|----------------|--|-------------|-------------|--------|
| 075 171 222508 | 8 MOD. DÖŞ. ALTI PRİZ S.(BOŞ) 221X255 | 1 | ad. | 55,065 |
| 075 171 333308 | 8 MOD. DÖŞ. ALTI PRİZ S.BUAT 330X330 | 1 | ad. | 59,529 |
| 075 171 272712 | 12 MOD. DÖŞ. ALTI PRİZ S.(BOŞ) 270X270 | 1 | ad. | 75,900 |
| 075 171 424212 | 12 MOD. DÖŞ. ALTI PRİZ S.BUAT 420X420 | 1 | ad. | 83,431 |

MEKSPLUS SERİSİ 100X37/50 İÇİN PRİZ SETİ (45X45)

| Kod | Açıklama / Stok Cinsi | Amb. (Kutu) | Amb. Birimi | FİYAT |
|----------------------|-----------------------------------|-------------|-------------|-------|
| 001 047 070001 00 00 | 100X37/50 İÇİN 45X45 PMS (TEKLİ) | 20 | ad. | 3,619 |
| 001 047 070002 00 00 | 100X37/50 İÇİN 45X45 PMS (İKİLİ) | 14 | ad. | 4,583 |
| 001 047 070003 00 00 | 100X37/50 İÇİN 45X45 PMS (ÜÇLÜ) | 12 | ad. | 4,782 |
| 001 047 070004 00 00 | 100X37/50 İÇİN 45X45 PMS (DÖRTLÜ) | 10 | ad. | 5,538 |

MEKSPLUS SERİSİ 100X37/50 İÇİN P. SETİ (55X55)

| Kod | Açıklama / Stok Cinsi | Amb. (Kutu) | Amb. Birimi | FİYAT |
|----------------------|----------------------------------|-------------|-------------|-------|
| 001 047 080001 00 00 | 100X37/50 İÇİN 55X55 PMS (TEKLİ) | 20 | ad. | 3,619 |
| 001 047 080002 00 00 | 100X37/50 İÇİN 55X55 PMS (İKİLİ) | 14 | ad. | 3,933 |
| 001 047 080003 00 00 | 100X37/50 İÇİN 55X55 PMS (ÜÇLÜ) | 12 | ad. | 5,313 |

MEKS SERİSİ 100'LÜK KANAL P. MONTAJ SETİ (55X55)

| Kod | Açıklama / Stok Cinsi | Amb. (Kutu) | Amb. Birimi | FİYAT |
|----------------------|-------------------------|-------------|-------------|-------|
| 001 047 020001 00 00 | 100'LÜK 55X55 PMS TEKLİ | 20 | ad. | 3,619 |
| 001 047 020002 00 00 | 100'LÜK 55X55 PMS İKİLİ | 14 | ad. | 4,543 |
| 001 047 020003 00 00 | 100'LÜK 55X55 PMS ÜÇLÜ | 12 | ad. | 5,844 |

MEKS SERİSİ 100'LÜK KANAL P. MONTAJ SETİ (45X45)

| Kod | Açıklama / Stok Cinsi | Amb. (Kutu) | Amb. Birimi | FİYAT |
|----------------------|--------------------------|-------------|-------------|-------|
| 001 047 040001 00 00 | 100'LÜK 45X45 PMS TEKLİ | 20 | ad. | 3,619 |
| 001 047 040002 00 00 | 100'LÜK 45X45 PMS İKİLİ | 14 | ad. | 4,071 |
| 001 047 040003 00 00 | 100'LÜK 45X45 PMS ÜÇLÜ | 12 | ad. | 4,649 |
| 001 047 040004 00 00 | 100'LÜK 45X45 PMS DÖRTLÜ | 10 | ad. | 5,247 |

120X60 KANAL AKSESUARLARI

| Kod | Açıklama / Stok Cinsi | Amb. (Kutu) | Amb. Birimi | FİYAT |
|----------------------|-----------------------|-------------|-------------|-------|
| 001 039 120060 00 00 | 120X60 MM İÇ KÖŞE | 8 | ad. | 4,915 |
| 001 040 120060 00 00 | 120X60 MM DIŞ KÖŞE | 8 | ad. | 4,915 |
| 001 041 120060 00 00 | 120X60 MM T PARÇA | 8 | ad. | 4,915 |
| 001 042 120060 00 00 | 120X60 MM 90 L KÖŞE | 8 | ad. | 4,915 |
| 001 044 120060 00 00 | 120X60 MM UÇ TAPA | 20 | ad. | 1,915 |
| 001 043 120060 00 00 | 120X60 MM EK PARÇA | 50 | ad. | 1,416 |

SİDEM SERİSİ RENKLİ KABLO KANALLARI

| Kod | Açıklama / Stok Cinsi | Amb. (Kutu) | Amb. Birimi | FİYAT |
|----------------------|-----------------------------|-------------|-------------|--------|
| 001 007 010008 20 01 | 10X8 MM (SİDEM) | 330 | mt. | 3,673 |
| 001 007 012012 20 01 | 12X12 MM (SİDEM) | 250 | mt. | 3,864 |
| 001 007 015010 20 01 | 15X10 MM (SİDEM) | 250 | mt. | 3,687 |
| 001 007 016016 20 01 | 16X16 MM (SİDEM) | 250 | mt. | 4,409 |
| 001 007 020010 20 01 | 20X10 MM (SİDEM) | 200 | mt. | 3,890 |
| 001 007 025016 20 01 | 25X16 MM (SİDEM) | 150 | mt. | 5,187 |
| 001 007 025025 20 01 | 25X25 MM (SİDEM) | 100 | mt. | 6,956 |
| 001 007 930010 20 01 | 30X10 MM (SİDEM) BÖLMELİ | 140 | mt. | 5,377 |
| 001 007 930016 20 01 | 30X16 MM (SİDEM) BÖLMELİ | 140 | mt. | 6,872 |
| 001 007 030025 20 01 | 30X25 MM (SİDEM) | 80 | mt. | 7,416 |
| 001 007 040016 20 01 | 40X16 MM (SİDEM) | 100 | mt. | 6,924 |
| 001 007 940016 20 01 | 40X16 MM (SİDEM)(BÖLMELİ) | 100 | mt. | 7,723 |
| 001 007 040025 20 01 | 40X25 MM (SİDEM) | 80 | mt. | 9,138 |
| 001 007 040040 20 01 | 40X40 MM (SİDEM) | 50 | mt. | 11,437 |
| 001 007 960025 20 01 | 60X25 MM (SİDEM) BÖLMELİ | 40 | mt. | 13,641 |
| 001 007 060040 20 01 | 60X40 MM (SİDEM) | 40 | mt. | 14,220 |
| 001 007 060060 20 01 | 60X60 MM (SİDEM) | 32 | mt. | 19,826 |
| 001 007 975022 20 01 | 75X22 MM (SİDEM) BÖLMELİ | 50 | mt. | 17,341 |
| 001 007 080040 20 01 | 80X40 MM (SİDEM) | 30 | mt. | 18,799 |
| 001 007 080060 20 01 | 80X60 MM (SİDEM) | 24 | mt. | 22,666 |
| 001 007 100036 20 01 | 100X36 MM (SİDEM) | 30 | mt. | 24,864 |
| 001 007 100040 20 01 | 100X40 MM (SİDEM) | 24 | mt. | 20,536 |
| 001 007 100048 20 01 | 100X48 MM (SİDEM) | 24 | mt. | 27,347 |
| 001 007 100060 20 01 | 100X60 MM (SİDEM) | 20 | mt. | 29,388 |
| 001 007 075060 20 01 | 75X60 MM (SİDEM) | 30 | mt. | 22,157 |
| 001 007 100037 20 01 | 100X37 MM (SİDEM) I.KAPAKLI | 30 | mt. | 24,080 |
| 001 007 100050 20 01 | 100X50 MM (SİDEM) I.KAPAKLI | 20 | mt. | 27,660 |
| 001 007 120060 20 01 | 120X60 MM (SİDEM) I.KAPAKLI | 16 | mt. | 33,910 |
| 001 007 120070 20 01 | 120X70 MM (SİDEM) | 16 | mt. | 49,402 |
| 001 007 170070 20 01 | 170X70 MM (SİDEM) | 12 | mt. | 51,813 |

SİDEM SERİSİ SÜPÜRĞELİKLER VE AKSESUARLARI

| Kod | Açıklama / Stok Cinsi | Amb. (Kutu) | Amb. Birimi | FİYAT |
|----------------------|---------------------------------|-------------|-------------|--------|
| 001 007 060015 20 01 | 60X15 MM (SİDEM) | 80 | mt. | 10,474 |
| 001 031 060015 00 01 | 60X15 MM L KÖŞE(SİDEM) | 1 | ad. | 3,753 |
| 001 032 060015 00 01 | 60X15 MM EK PARÇA (SİDEM) | 1 | ad. | 1,761 |
| 001 033 060015 00 01 | 60X15 MM SONLAMA KAPAĞI (SİDEM) | 1 | ad. | 1,826 |
| 001 030 060015 00 01 | 60X15 MM T KÖŞE (SİDEM) | 1 | ad. | 4,291 |
| 001 007 075018 20 01 | 75X18 MM (SİDEM) | 60 | mt. | 16,833 |
| 001 007 090020 20 01 | 90X20 MM (SİDEM) | 40 | mt. | 23,829 |

SİDEM SERİSİ RENKLİ KABLO KANALLARI (YAPIŞKANLI)



| Kod | Açıklama / Stok Cinsi | Amb. (Kutu) | Amb. Birimi | FİYAT |
|----------------------|-----------------------------|-------------|-------------|--------|
| 001 155 010008 20 01 | 10X8 MM (SİDEM) YAPIŞKANLI | 330 | mt. | 3,880 |
| 001 155 012012 20 01 | 12X12 MM (SİDEM) YAPIŞKANLI | 250 | mt. | 4,033 |
| 001 155 015010 20 01 | 15X10 MM (SİDEM) YAPIŞKANLI | 250 | mt. | 4,000 |
| 001 155 016016 20 01 | 16X16 MM (SİDEM) YAPIŞKANLI | 250 | mt. | 4,643 |
| 001 155 020010 20 01 | 20X10 MM (SİDEM) YAPIŞKANLI | 180 | mt. | 4,285 |
| 001 155 025016 20 01 | 25X16 MM (SİDEM) YAPIŞKANLI | 150 | mt. | 5,670 |
| 001 155 025025 20 01 | 25X25 MM (SİDEM) YAPIŞKANLI | 100 | mt. | 7,144 |
| 001 155 930010 20 01 | 30X10 MM (SİDEM) YAPIŞKANLI | 140 | mt. | 4,923 |
| 001 155 930016 20 01 | 30X16 MM (SİDEM) YAPIŞKANLI | 140 | mt. | 7,044 |
| 001 155 030025 20 01 | 30X25 MM (SİDEM) YAPIŞKANLI | 80 | mt. | 7,566 |
| 001 155 040016 20 01 | 40X16 MM (SİDEM) YAPIŞKANLI | 100 | mt. | 11,786 |
| 001 155 040025 20 01 | 40X25 MM (SİDEM) YAPIŞKANLI | 80 | mt. | 10,062 |
| 001 155 040040 20 01 | 40X40 MM (SİDEM) YAPIŞKANLI | 50 | mt. | 12,350 |
| 001 155 960025 20 01 | 60X25 MM (SİDEM) YAPIŞKANLI | 40 | mt. | 15,069 |
| 001 155 060015 20 01 | 60X15 MM (SİDEM) YAPIŞKANLI | 50 | mt. | 12,103 |
| 001 155 075018 20 01 | 75X18 MM (SİDEM) YAPIŞKANLI | 50 | mt. | 18,249 |
| 001 155 060040 20 01 | 60X40 MM (SİDEM) YAPIŞKANLI | 40 | mt. | 16,531 |

12X12 KANAL AKSESUARLARI (SİDEM SERİSİ)

| Kod | Açıklama / Stok Cinsi | Amb. (Kutu) | Amb. Birimi | FİYAT |
|----------------------|-----------------------------|-------------|-------------|-------|
| 001 028 012012 00 01 | 12X12 MM (SİDEM) İÇ KÖŞE | 1 | ad. | 1,083 |
| 001 029 012012 00 01 | 12X12 MM (SİDEM) DIŞ KÖŞE | 1 | ad. | 1,108 |
| 001 030 012012 00 01 | 12X12 MM (SİDEM) T KÖŞE | 1 | ad. | 1,107 |
| 001 031 012012 00 01 | 12X12 MM (SİDEM) 90 L KÖŞE | 1 | ad. | 1,114 |
| 001 033 012012 00 01 | 12X12 MM (SİDEM) UÇ TAPA | 1 | ad. | 1,080 |
| 001 032 012012 00 01 | 12X12 MM (SİDEM) EK PARÇASI | 1 | ad. | 1,090 |

| Kod | Açıklama / Stok Cinsi | Amb. (Kutu) | Amb. Birimi | FİYAT |
|--|-----------------------------|-------------|-------------|-------|
| 20X10 KANAL AKSESUARLARI (SİDEM SERİSİ) | | | | |
| 001 028 020010 00 01 | 20X10 MM (SİDEM) İÇ KÖŞE | 1 | ad. | 1,188 |
| 001 029 020010 00 01 | 20X10 MM (SİDEM) DIŞ KÖŞE | 1 | ad. | 1,177 |
| 001 030 020010 00 01 | 20X10 MM (SİDEM) T KÖŞE | 1 | ad. | 1,092 |
| 001 031 020010 00 01 | 20X10 MM (SİDEM) 90 L KÖŞE | 1 | ad. | 1,116 |
| 001 033 020010 00 01 | 20X10 MM (SİDEM) UÇ TAPA | 1 | ad. | 1,086 |
| 001 032 020010 00 01 | 20X10 MM (SİDEM) EK PARÇASI | 1 | ad. | 1,086 |

| Kod | Açıklama / Stok Cinsi | Amb. (Kutu) | Amb. Birimi | FİYAT |
|--|------------------------------|-------------|-------------|--------|
| 25X16 KANAL AKSESUARLARI (SİDEM SERİSİ) | | | | |
| 001 028 025016 00 01 | 25X16 MM (SİDEM) İÇ KÖŞE | 1 | ad. | 2,055 |
| 001 029 025016 00 01 | 25X16 MM (SİDEM) DIŞ KÖŞE | 1 | ad. | 1,684 |
| 001 030 025016 00 01 | 25X16 MM (SİDEM) T KÖŞE | 1 | ad. | 2,030 |
| 001 031 025016 00 01 | 25X16 MM (SİDEM) 90 L KÖŞE | 1 | ad. | 1,678 |
| 001 033 025016 00 01 | 25X16 MM (SİDEM) UÇ TAPA | 1 | ad. | 1,570 |
| 001 032 025016 00 01 | 25X16 MM (SİDEM) EK PARÇA | 1 | ad. | 1,625 |
| 001 034 017421 00 01 | 25X16 MM (SİDEM) PMK (45X45) | 1 | ad. | 12,239 |

| Kod | Açıklama / Stok Cinsi | Amb. (Kutu) | Amb. Birimi | FİYAT |
|--|------------------------------|-------------|-------------|--------|
| 25X25 KANAL AKSESUARLARI (SİDEM SERİSİ) | | | | |
| 001 028 025025 00 01 | 25X25 MM (SİDEM) İÇ KÖŞE | 1 | ad. | 2,185 |
| 001 029 025025 00 01 | 25X25 MM (SİDEM) DIŞ KÖŞE | 1 | ad. | 2,216 |
| 001 030 025025 00 01 | 25X25 MM (SİDEM) T PARÇASI | 1 | ad. | 2,247 |
| 001 031 025025 00 01 | 25X25 MM (SİDEM) 90 L KÖŞE | 1 | ad. | 1,771 |
| 001 033 025025 00 01 | 25X25 MM (SİDEM) UÇ TAPA | 1 | ad. | 1,690 |
| 001 032 025025 00 01 | 25X25 MM (SİDEM) EK PARÇA | 1 | ad. | 1,614 |
| 001 034 017421 00 01 | 25X25 MM (SİDEM) PMK (45X45) | 1 | ad. | 12,239 |

| Kod | Açıklama / Stok Cinsi | Amb. (Kutu) | Amb. Birimi | FİYAT |
|--|----------------------------|-------------|-------------|-------|
| 30X10 KANAL AKSESUARLARI (SİDEM SERİSİ) | | | | |
| 001 028 030010 00 01 | 30X10 MM (SİDEM) İÇ KÖŞE | 1 | ad. | 2,189 |
| 001 029 030010 00 01 | 30X10 MM (SİDEM) DIŞ KÖŞE | 1 | ad. | 2,379 |
| 001 030 030010 00 01 | 30X10 MM (SİDEM) T PARÇASI | 1 | ad. | 2,228 |
| 001 031 030010 00 01 | 30X10 MM (SİDEM) 90 L KÖŞE | 1 | ad. | 2,216 |
| 001 033 030010 00 01 | 30X10 MM (SİDEM) UÇ TAPA | 1 | ad. | 2,216 |
| 001 032 030010 00 01 | 30X10 MM (SİDEM) EK PARÇA | 1 | ad. | 2,076 |

| Kod | Açıklama / Stok Cinsi | Amb. (Kutu) | Amb. Birimi | FİYAT |
|--|----------------------------|-------------|-------------|-------|
| 30X16 KANAL AKSESUARLARI (SİDEM SERİSİ) | | | | |
| 001 028 030016 00 01 | 30X16 MM (SİDEM) İÇ KÖŞE | 1 | ad. | 2,366 |
| 001 029 030016 00 01 | 30X16 MM (SİDEM) DIŞ KÖŞE | 1 | ad. | 2,486 |
| 001 030 030016 00 01 | 30X16 MM (SİDEM) T PARÇASI | 1 | ad. | 2,383 |
| 001 031 030016 00 01 | 30X16 MM (SİDEM) 90 L KÖŞE | 1 | ad. | 2,346 |
| 001 033 030016 00 01 | 30X16 MM (SİDEM) UÇ TAPA | 1 | ad. | 2,256 |
| 001 032 030016 00 01 | 30X16 MM (SİDEM) EK PARÇA | 1 | ad. | 2,246 |

| Kod | Açıklama / Stok Cinsi | Amb. (Kutu) | Amb. Birimi | FİYAT |
|--|----------------------------|-------------|-------------|-------|
| 30X25 KANAL AKSESUARLARI (SİDEM SERİSİ) | | | | |
| 001 028 030025 00 01 | 30X25 MM (SİDEM) İÇ KÖŞE | 1 | ad. | 2,616 |
| 001 029 030025 00 01 | 30X25 MM (SİDEM) DIŞ KÖŞE | 1 | ad. | 2,796 |
| 001 030 030025 00 01 | 30X25 MM (SİDEM) T PARÇASI | 1 | ad. | 2,407 |
| 001 031 030025 00 01 | 30X25 MM (SİDEM) 90 L KÖŞE | 1 | ad. | 2,381 |
| 001 033 030025 00 01 | 30X25 MM (SİDEM) UÇ TAPA | 1 | ad. | 2,277 |
| 001 032 030025 00 01 | 30X25 MM (SİDEM) EK PARÇA | 1 | ad. | 2,262 |

| Kod | Açıklama / Stok Cinsi | Amb. (Kutu) | Amb. Birimi | FİYAT |
|--|------------------------------|-------------|-------------|--------|
| 40X16 KANAL AKSESUARLARI (SİDEM SERİSİ) | | | | |
| 001 028 040016 00 01 | 40X16 MM (SİDEM) İÇ KÖŞE | 1 | ad. | 2,972 |
| 001 029 040016 00 01 | 40X16 MM (SİDEM) DIŞ KÖŞE | 1 | ad. | 2,600 |
| 001 030 040016 00 01 | 40X16 MM (SİDEM) T KÖŞE | 1 | ad. | 2,557 |
| 001 031 040016 00 01 | 40X16 MM (SİDEM) 90 L KÖŞE | 1 | ad. | 2,511 |
| 001 033 040016 00 01 | 40X16 MM (SİDEM) UÇ TAPA | 1 | ad. | 2,290 |
| 001 032 040016 00 01 | 40X16 MM (SİDEM) EK PARÇASI | 1 | ad. | 2,382 |
| 001 034 017421 00 01 | 40X16 MM (SİDEM) PMK (45X45) | 1 | ad. | 12,239 |

| Kod | Açıklama / Stok Cinsi | Amb. (Kutu) | Amb. Birimi | FİYAT |
|--|------------------------------|-------------|-------------|--------|
| 40X25 KANAL AKSESUARLARI (SİDEM SERİSİ) | | | | |
| 001 028 040025 00 01 | 40X25 MM (SİDEM) İÇ KÖŞE | 1 | ad. | 2,642 |
| 001 029 040025 00 01 | 40X25 MM (SİDEM) DIŞ KÖŞE | 1 | ad. | 2,904 |
| 001 030 040025 00 01 | 40X25 MM (SİDEM) T KÖŞE | 1 | ad. | 2,687 |
| 001 031 040025 00 01 | 40X25 MM (SİDEM) 90 L KÖŞE | 1 | ad. | 2,664 |
| 001 033 040025 00 01 | 40X25 MM (SİDEM) UÇ TAPA | 1 | ad. | 2,490 |
| 001 032 040025 00 01 | 40X25 MM (SİDEM) EK PARÇASI | 1 | ad. | 2,490 |
| 001 034 017421 00 01 | 40X25 MM (SİDEM) PMK (45X45) | 1 | ad. | 12,239 |

| Kod | Açıklama / Stok Cinsi | Amb. (Kutu) | Amb. Birimi | FİYAT |
|--|------------------------------|-------------|-------------|--------|
| 40X40 KANAL AKSESUARLARI (SİDEM SERİSİ) | | | | |
| 001 028 040040 00 01 | 40X40 MM (SİDEM) İÇ KÖŞE | 1 | ad. | 3,268 |
| 001 029 040040 00 01 | 40X40 MM (SİDEM) DIŞ KÖŞE | 1 | ad. | 3,360 |
| 001 030 040040 00 01 | 40X40 MM (SİDEM) T PARÇASI | 1 | ad. | 2,808 |
| 001 031 040040 00 01 | 40X40 MM (SİDEM) 90 L KÖŞE | 1 | ad. | 2,821 |
| 001 033 040040 00 01 | 40X40 MM (SİDEM) UÇ TAPA | 1 | ad. | 2,624 |
| 001 032 040040 00 01 | 40X40 MM (SİDEM) EK PARÇA | 1 | ad. | 2,647 |
| 001 034 017421 00 01 | 40X40 MM (SİDEM) PMK (45X45) | 1 | ad. | 12,239 |

| Kod | Açıklama / Stok Cinsi | Amb. (Kutu) | Amb. Birimi | FİYAT |
|--|------------------------------|-------------|-------------|-------|
| 75X22 KANAL AKSESUARLARI (SİDEM SERİSİ) | | | | |
| 001 028 075022 00 01 | 75X22 MM (SİDEM) İÇ KÖŞE | 1 | ad. | 3,362 |
| 001 029 075022 00 01 | 75X22 MM (SİDEM) DIŞ KÖŞE | 1 | ad. | 3,517 |
| 001 033 075022 01 01 | 75X22 MM (SİDEM) SAĞ SONLAMA | 1 | ad. | 3,269 |
| 001 033 075022 02 01 | 75X22 MM (SİDEM) SOL SONLAMA | 1 | ad. | 3,238 |
| 001 032 075022 00 01 | 75X22 MM (SİDEM) EK PARÇASI | 1 | ad. | 3,352 |

| Kod | Açıklama / Stok Cinsi | Amb. (Kutu) | Amb. Birimi | FİYAT |
|--|----------------------------|-------------|-------------|-------|
| 60X25 KANAL AKSESUARLARI (SİDEM SERİSİ) | | | | |
| 001 028 060025 00 01 | 60X25 MM (SİDEM) İÇ KÖŞE | 1 | ad. | 5,848 |
| 001 029 060025 00 01 | 60X25 MM (SİDEM) DIŞ KÖŞE | 1 | ad. | 5,863 |
| 001 030 060025 00 01 | 60X25 MM (SİDEM) T PARÇASI | 1 | ad. | 5,907 |
| 001 031 060025 00 01 | 60X25 MM (SİDEM) 90 L KÖŞE | 1 | ad. | 5,932 |
| 001 033 060025 00 01 | 60X25 MM (SİDEM) UÇ TAPA | 1 | ad. | 2,580 |
| 001 032 060025 00 01 | 60X25 MM (SİDEM) EK PARÇA | 1 | ad. | 2,263 |

| Kod | Açıklama / Stok Cinsi | Amb. (Kutu) | Amb. Birimi | FİYAT |
|--|----------------------------|-------------|-------------|-------|
| 60X40 KANAL AKSESUARLARI (SİDEM SERİSİ) | | | | |
| 001 028 060040 00 01 | 60X40 MM (SİDEM) İÇ KÖŞE | 1 | ad. | 5,805 |
| 001 029 060040 00 01 | 60X40 MM (SİDEM) DIŞ KÖŞE | 1 | ad. | 5,843 |
| 001 030 060040 00 01 | 60X40 MM (SİDEM) T PARÇASI | 1 | ad. | 5,851 |
| 001 031 060040 00 01 | 60X40 MM (SİDEM) 90 L KÖŞE | 1 | ad. | 6,142 |
| 001 033 060040 00 01 | 60X40 MM (SİDEM) UÇ TAPA | 1 | ad. | 2,786 |
| 001 032 060040 00 01 | 60X40 MM (SİDEM) EK PARÇA | 1 | ad. | 2,495 |

| Kod | Açıklama / Stok Cinsi | Amb. (Kutu) | Amb. Birimi | FİYAT |
|--|----------------------------|-------------|-------------|-------|
| 60X60 KANAL AKSESUARLARI (SİDEM SERİSİ) | | | | |
| 001 028 060060 00 01 | 60X60 MM (SİDEM) İÇ KÖŞE | 1 | ad. | 5,869 |
| 001 029 060060 00 01 | 60X60 MM (SİDEM) DIŞ KÖŞE | 1 | ad. | 5,869 |
| 001 030 060060 00 01 | 60X60 MM (SİDEM) T PARÇASI | 1 | ad. | 5,877 |
| 001 031 060060 00 01 | 60X60 MM (SİDEM) 90 L KÖŞE | 1 | ad. | 5,895 |
| 001 033 060060 00 01 | 60X60 MM (SİDEM) UÇ TAPA | 1 | ad. | 2,855 |
| 001 032 060060 00 01 | 60X60 MM (SİDEM) EK PARÇA | 1 | ad. | 2,641 |

| Kod | Açıklama / Stok Cinsi | Amb. (Kutu) | Amb. Birimi | FİYAT |
|--|----------------------------|-------------|-------------|-------|
| 80X40 KANAL AKSESUARLARI (SİDEM SERİSİ) | | | | |
| 001 028 080040 00 01 | 80X40 MM (SİDEM) İÇ KÖŞE | 1 | ad. | 6,545 |
| 001 029 080040 00 01 | 80X40 MM (SİDEM) DIŞ KÖŞE | 1 | ad. | 6,568 |
| 001 030 080040 00 01 | 80X40 MM (SİDEM) T PARÇASI | 1 | ad. | 6,643 |
| 001 031 080040 00 01 | 80X40 MM (SİDEM) 90 L KÖŞE | 1 | ad. | 6,623 |
| 001 033 080040 00 01 | 80X40 MM (SİDEM) UÇ TAPA | 1 | ad. | 2,844 |
| 001 032 080040 00 01 | 80X40 MM (SİDEM) EK PARÇA | 1 | ad. | 2,862 |

| Kod | Açıklama / Stok Cinsi | Amb. (Kutu) | Amb. Birimi | FİYAT |
|--|----------------------------|-------------|-------------|-------|
| 80X60 KANAL AKSESUARLARI (SİDEM SERİSİ) | | | | |
| 001 028 080060 00 01 | 80X60 MM (SİDEM) İÇ KÖŞE | 1 | ad. | 6,828 |
| 001 029 080060 00 01 | 80X60 MM (SİDEM) DIŞ KÖŞE | 1 | ad. | 7,297 |
| 001 030 080060 00 01 | 80X60 MM (SİDEM) T PARÇASI | 1 | ad. | 7,416 |
| 001 031 080060 00 01 | 80X60 MM (SİDEM) 90 L KÖŞE | 1 | ad. | 7,469 |
| 001 033 080060 00 01 | 80X60 MM (SİDEM) UÇ TAPA | 1 | ad. | 3,159 |
| 001 032 080060 00 01 | 80X60 MM (SİDEM) EK PARÇA | 1 | ad. | 3,497 |

| Kod | Açıklama / Stok Cinsi | Amb. (Kutu) | Amb. Birimi | FİYAT |
|---|------------------------------------|-------------|-------------|-------|
| 100X37 KANAL AKSESUARLARI (SİDEM SERİSİ) | | | | |
| 001 028 100037 00 01 | 100X37 MM (SİDEM) İÇ KÖŞE (SABİT) | 1 | ad. | 6,807 |
| 001 029 100037 00 01 | 100X37 MM (SİDEM) DIŞ KÖŞE (SABİT) | 1 | ad. | 7,468 |
| 001 028 100037 01 01 | 100X37 MM (SİDEM) İÇ KÖŞE (HARKT) | 1 | ad. | 7,044 |
| 001 029 100037 01 01 | 100X37 MM (SİDEM) DIŞ KÖŞE (HARKT) | 1 | ad. | 7,600 |
| 001 030 100037 00 01 | 100X37 MM (SİDEM) T PARÇASI | 1 | ad. | 6,930 |
| 001 031 100037 00 01 | 100X37 MM (SİDEM) 90 L KÖŞE | 1 | ad. | 7,087 |
| 001 033 100037 00 01 | 100X37 MM (SİDEM) UÇ TAPA | 1 | ad. | 3,184 |
| 001 032 100037 00 01 | 100X37 MM (SİDEM) EK PARÇA | 1 | ad. | 2,889 |

| Kod | Açıklama / Stok Cinsi | Amb. (Kutu) | Amb. Birimi | FİYAT |
|---|------------------------------------|-------------|-------------|-------|
| 100X36 KANAL AKSESUARLARI (SİDEM SERİSİ) | | | | |
| 001 028 100036 00 01 | 100X36 MM (SİDEM) İÇ KÖŞE (SABİT) | 1 | ad. | 6,826 |
| 001 029 100036 00 01 | 100X36 MM (SİDEM) DIŞ KÖŞE (SABİT) | 1 | ad. | 6,891 |
| 001 028 100036 01 01 | 100X36 MM (SİDEM) İÇ KÖŞE (HARKT) | 1 | ad. | 6,891 |
| 001 029 100036 01 01 | 100X36 MM (SİDEM) DIŞ KÖŞE (HARKT) | 1 | ad. | 6,891 |
| 001 030 100036 00 01 | 100X36 MM (SİDEM) T PARÇASI | 1 | ad. | 6,968 |
| 001 031 100036 00 01 | 100X36 MM (SİDEM) 90 L KÖŞE | 1 | ad. | 7,586 |
| 001 033 100036 00 01 | 100X36 MM (SİDEM) UÇ TAPA | 1 | ad. | 2,849 |
| 001 032 100036 00 01 | 100X36 MM (SİDEM) EK PARÇA | 1 | ad. | 2,043 |

| Kod | Açıklama / Stok Cinsi | Amb. (Kutu) | Amb. Birimi | FİYAT |
|---|------------------------------------|-------------|-------------|-------|
| 100X40 KANAL AKSESUARLARI (SİDEM SERİSİ) | | | | |
| 001 028 100040 00 01 | 100X40 MM (SİDEM) İÇ KÖŞE (SABİT) | 1 | ad. | 7,423 |
| 001 029 100040 00 01 | 100X40 MM (SİDEM) DIŞ KÖŞE (SABİT) | 1 | ad. | 7,559 |
| 001 028 100040 01 01 | 100X40 MM (SİDEM) İÇ KÖŞE (HARKT) | 1 | ad. | 7,423 |
| 001 029 100040 01 01 | 100X40 MM (SİDEM) DIŞ KÖŞE (HARKT) | 1 | ad. | 7,559 |
| 001 030 100040 00 01 | 100X40 MM (SİDEM) T PARÇASI | 1 | ad. | 7,630 |
| 001 031 100040 00 01 | 100X40 MM (SİDEM) 90 L KÖŞE | 1 | ad. | 7,564 |
| 001 033 100040 00 01 | 100X40 MM (SİDEM) UÇ TAPA | 1 | ad. | 2,849 |
| 001 032 100040 00 01 | 100X40 MM (SİDEM) EK PARÇA | 1 | ad. | 2,043 |

CANALEX

EKO SERISI

MEKS SERISI

KABLOLU SİRALLER

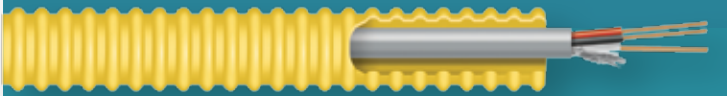
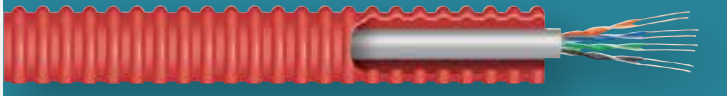

LED PANELLER

MEKS PLUS

H-FREE SPİLLARER

COMFORT SERISI



SPİRALLİ KABLolar

Ürün Listesi

YENİ

SPİRALLİ ENERJİ KABLolar

| Kablo Kesit mm ² | Boru Özellik | Boru Çap (mm) |
|-----------------------------|--------------|---------------|
|-----------------------------|--------------|---------------|

H07V-U (NYA) KABLolar

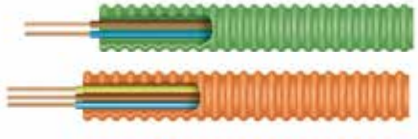

| | | |
|-------|-------|----|
| 2X1,5 | HF-PE | 14 |
| 3X1,5 | HF-PE | 14 |
| 4X1,5 | HF-PE | 16 |



| | | |
|-------|-------|----|
| 2X2,5 | HF-PE | 14 |
| 3X2,5 | HF-PE | 16 |
| 4X2,5 | HF-PE | 20 |

SPİRALLİ ZAYIF AKIM KABLolar

| Kablo Kesit mm ² | Boru Özellik | Boru Çap (mm) |
|-----------------------------|--------------|---------------|
|-----------------------------|--------------|---------------|

DATA KABLolar



| | | |
|-----------|-------|----|
| UTP CAT5e | HF-PE | 16 |
| UTP CAT6e | HF-PE | 16 |

KOAKSİYEL KABLolar



| | | |
|---------------|-------|----|
| RG 59/U2 (cu) | HF-PE | 14 |
| RG 6/U4 (cu) | HF-PE | 16 |
| RG 6/U6 (cu) | HF-PE | 16 |

CCTV KAMERA KABLolar

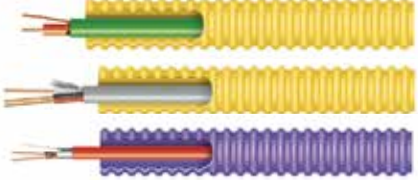

| | | |
|-------------------------------------|-------|----|
| CCTV 1+2(2X0.22 mm ²) | HF-PE | 14 |
| CCTV 1+4(2X2x0.22 mm ²) | HF-PE | 16 |

YANGIN İHBAR KABLolar



| | | |
|------------------------------------|-------|----|
| JY(st)Y 1x2x0.80+40mm ² | HF-PE | 16 |
| JY(st)Y 2x2x0.80+40mm ² | HF-PE | 16 |
| JY(st)Y 4x2x0.80+40mm ² | HF-PE | 20 |

DİAFON KABLolar



| | | |
|-------------------------------|-------|----|
| LIYY 8 X 0.22 mm ² | HF-PE | 16 |
|-------------------------------|-------|----|



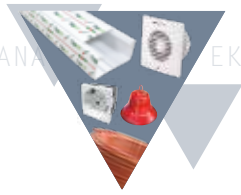

| Kod | Açıklama / Stok Cinsi | Amb. Kutu/Bağ | Amb. Koli/Çyl | FİYAT |
|--|-----------------------------------|---------------|---------------|-------|
| EKO SERİSİ PLASTİK SİRALLER (SİYAH) | | | | |
| 001 020 401011 00 11 | 11 Ø PLASTİK SİRALLER (SİYAH) EKO | 100 mt. | 1000 | 0,417 |
| 001 020 401014 00 11 | 14 Ø PLASTİK SİRALLER (SİYAH) EKO | 100 mt. | 1000 | 0,417 |
| 001 020 401018 00 11 | 18 Ø PLASTİK SİRALLER (SİYAH) EKO | 100 mt. | 1000 | 0,595 |
| 001 020 401020 00 11 | 20 Ø PLASTİK SİRALLER (SİYAH) EKO | 100 mt. | 1000 | 0,595 |
| 001 020 401026 00 11 | 26 Ø PLASTİK SİRALLER (SİYAH) EKO | 100 mt. | 500 | 0,744 |
| 001 020 401032 00 11 | 32 Ø PLASTİK SİRALLER (SİYAH) EKO | 100 mt. | 500 | 1,069 |

| Kod | Açıklama / Stok Cinsi | Amb. Kutu/Bağ | Amb. Koli/Çyl | FİYAT |
|---|-------------------------------|---------------|---------------|-------|
| MEKS SERİSİ PLASTİK SİRALLER (SİYAH) | | | | |
| 001 020 400014 00 11 | 14 Ø PLASTİK SİRALLER (SİYAH) | 100 mt. | 1000 | 0,414 |
| 001 020 400016 00 11 | 16 Ø PLASTİK SİRALLER (SİYAH) | 100 mt. | 1000 | 0,450 |
| 001 020 400018 00 11 | 18 Ø PLASTİK SİRALLER (SİYAH) | 50 mt. | 500 | 0,620 |
| 001 020 400020 00 11 | 20 Ø PLASTİK SİRALLER (SİYAH) | 50 mt. | 500 | 0,620 |
| 001 020 400026 00 11 | 26 Ø PLASTİK SİRALLER (SİYAH) | 50 mt. | 250 | 0,791 |
| 001 020 400032 00 11 | 32 Ø PLASTİK SİRALLER (SİYAH) | 50 mt. | 250 | 1,011 |
| 001 020 400040 00 11 | 40 Ø PLASTİK SİRALLER (SİYAH) | 25 mt. | 125 | 1,539 |
| 001 020 400050 00 11 | 50 Ø PLASTİK SİRALLER (SİYAH) | 25 mt. | 125 | 1,991 |

| Kod | Açıklama / Stok Cinsi | Amb. Kutu/Bağ | Amb. Koli/Çyl | FİYAT |
|---|-------------------------------------|---------------|---------------|-------|
| PLASTİK SİRALLER (SİYAH) (TELLİ) | | | | |
| 001 020 410014 00 11 | 14 Ø PLASTİK SİRALLER (SİYAH) TELLİ | 100 mt. | 1000 | 0,543 |
| 001 020 410016 00 11 | 16 Ø PLASTİK SİRALLER (SİYAH) TELLİ | 100 mt. | 1000 | 0,618 |
| 001 020 410018 00 11 | 18 Ø PLASTİK SİRALLER (SİYAH) TELLİ | 50 mt. | 500 | 0,732 |
| 001 020 410020 00 11 | 20 Ø PLASTİK SİRALLER (SİYAH) TELLİ | 50 mt. | 500 | 0,732 |
| 001 020 410026 00 11 | 26 Ø PLASTİK SİRALLER (SİYAH) TELLİ | 50 mt. | 250 | 0,953 |
| 001 020 410032 00 11 | 32 Ø PLASTİK SİRALLER (SİYAH) TELLİ | 50 mt. | 250 | 1,166 |
| 001 020 410040 00 11 | 40 Ø PLASTİK SİRALLER (SİYAH) TELLİ | 25 mt. | 125 | 1,602 |

| Kod | Açıklama / Stok Cinsi | Amb. Kutu/Bağ | Amb. Koli/Çyl | FİYAT |
|----------------------------------|------------------------------------|---------------|---------------|-------|
| PLASTİK SİRALLER (RENKLİ) | | | | |
| 001 020 400011 00 17 | 11 Ø PLS. SİRAL (GRI-BYZ-KIR-MAVI) | 100 mt. | 1000 | 0,595 |
| 001 020 400014 00 17 | 14 Ø PLS. SİRAL (GRI-BYZ-KIR-MAVI) | 100 mt. | 1000 | 0,595 |
| 001 020 400016 00 17 | 16 Ø PLS. SİRAL (GRI-BYZ-KIR-MAVI) | 100 mt. | 1000 | 0,716 |
| 001 020 400018 00 17 | 18 Ø PLS. SİRAL (GRI-BYZ-KIR-MAVI) | 50 mt. | 500 | 0,915 |
| 001 020 400020 00 17 | 20 Ø PLS. SİRAL (GRI-BYZ-KIR-MAVI) | 50 mt. | 250 | 0,915 |
| 001 020 400026 00 17 | 26 Ø PLS. SİRAL (GRI-BYZ-KIR-MAVI) | 50 mt. | 250 | 1,179 |
| 001 020 400032 00 17 | 32 Ø PLS. SİRAL (GRI-BYZ-KIR-MAVI) | 50 mt. | 250 | 1,952 |
| 001 020 400040 00 17 | 40 Ø PLS. SİRAL (GRI-BYZ-KIR-MAVI) | 25 mt. | 125 | 2,027 |
| 001 020 400050 00 17 | 50 Ø PLS. SİRAL (GRI-BYZ-KIR-MAVI) | 25 mt. | 125 | 3,174 |
| 001 020 990016 00 17 | 16MM SİRAL EK MUFU (GRI) | 200 ad. | | 0,238 |
| 001 020 990020 00 17 | 20MM SİRAL EK MUFU (GRI) | 200 ad. | | 0,316 |
| 001 020 990025 00 17 | 25MM SİRAL EK MUFU (GRI) | 100 ad. | | 0,433 |
| 001 020 990032 00 17 | 32MM SİRAL EK MUFU (GRI) | 200 ad. | | 0,487 |

| Kod | Açıklama / Stok Cinsi | Amb. Kutu/Bağ | Amb. Koli/Çyl | FİYAT |
|---------------------------------|---------------------------------|---------------|---------------|-------|
| PP POLYPROPİLEN SİRALLER | | | | |
| 001 020 160007 00 11 | MUT/PP-7 PP SİRAL BORU PSR7 | 100 mt. | 1000 | 0,429 |
| 001 020 160009 00 11 | MUT/PP-8,5 PP SİRAL BORU PSR7 | 100 mt. | 1000 | 0,536 |
| 001 020 160010 00 11 | MUT/PP-10 PP SİRAL BORU PSR9 | 100 mt. | 1000 | 0,578 |
| 001 020 160012 00 11 | MUT/PP-12 PP SİRAL BORU PSR11 | 50 mt. | 500 | 0,693 |
| 001 020 160014 00 11 | MUT/PP-14 PP SİRAL BORU PSR13,5 | 50 mt. | 250 | 0,924 |
| 001 020 160017 00 11 | MUT/PP-17 PP SİRAL BORU PSR16 | 50 mt. | 250 | 1,155 |
| 001 020 160019 00 11 | MUT/PP-19 PP SİRAL BORU | 50 mt. | 250 | 1,386 |
| 001 020 160023 00 11 | MUT/PP-23 PP SİRAL BORU PSR21 | 50 mt. | 250 | 1,155 |
| 001 020 160026 00 11 | MUT/PP-26 PP SİRAL BORU | 25 mt. | 125 | 1,617 |
| 001 020 160029 00 11 | MUT/PP-29 PP SİRAL BORU PSR29 | 25 mt. | 125 | 1,848 |
| 001 020 160036 00 11 | MUT/PP-36 PP SİRAL BORU PSR36 | 25 mt. | 125 | 2,542 |
| 001 020 160048 00 11 | MUT/PP-48 PP SİRAL BORU PSR48 | 25 mt. | 125 | 3,697 |

| Kod | Açıklama / Stok Cinsi | Amb. Kutu/Bağ | Amb. Koli/Çyl | FİYAT |
|--|----------------------------------|---------------|---------------|-------|
| PA6 POLYAMİD SİRALLER (A. YAYMAYAN) | | | | |
| 001 020 170007 00 11 | MUT/PA6-7 (A. YAYMAYAN) PSR7 | 100 mt. | 1000 | 0,689 |
| 001 020 170009 00 11 | MUT/PA6-8,5 (A. YAYMAYAN) PSR7 | 100 mt. | 1000 | 0,764 |
| 001 020 170010 00 11 | MUT/PA6-10 (A. YAYMAYAN) PSR9 | 100 mt. | 1000 | 0,969 |
| 001 020 170012 00 11 | MUT/PA6-12 (A. YAYMAYAN) PSR11 | 50 mt. | 500 | 1,209 |
| 001 020 170014 00 11 | MUT/PA6-14 (A. YAYMAYAN) PSR13,5 | 50 mt. | 250 | 1,790 |
| 001 020 170017 00 11 | MUT/PA6-17 (A. YAYMAYAN) PSR16 | 50 mt. | 250 | 1,944 |
| 001 020 170019 00 11 | MUT/PA6-19 (A. YAYMAYAN) | 50 mt. | 250 | 2,349 |
| 001 020 170023 00 11 | MUT/PA6-23 (A. YAYMAYAN) PSR21 | 50 mt. | 250 | 2,677 |
| 001 020 170026 00 11 | MUT/PA6-26 (A. YAYMAYAN) | 25 mt. | 125 | 3,070 |
| 001 020 170029 00 11 | MUT/PA6-29 (A. YAYMAYAN) PSR29 | 25 mt. | 125 | 3,512 |
| 001 020 170036 00 11 | MUT/PA6-36 (A. YAYMAYAN) PSR36 | 25 mt. | 125 | 5,526 |
| 001 020 170048 00 11 | MUT/PA6-48 (A. YAYMAYAN) PSR48 | 25 mt. | 125 | 6,425 |

| Kod | Açıklama / Stok Cinsi | Amb. Kutu/Bağ | Amb. Koli/Çyl | FİYAT |
|------------------------------|-----------------------|---------------|---------------|---------|
| POLYAMİD SİRAL REKORU | | | | |
| 057 097 110007 | PSR-7 SİRAL REKORU | 50 ad. | | 0,446 € |
| 057 097 110009 | PSR-9 SİRAL REKORU | 50 ad. | | 0,476 € |
| 057 097 110011 | PSR-11 SİRAL REKORU | 50 ad. | | 0,506 € |
| 057 097 110135 | PSR-13,5 SİRAL REKORU | 50 ad. | | 0,536 € |
| 057 097 110016 | PSR-16 SİRAL REKORU | 25 ad. | | 0,625 € |
| 057 097 110021 | PSR-21 SİRAL REKORU | 20 ad. | | 0,982 € |
| 057 097 110029 | PSR-29 SİRAL REKORU | 10 ad. | | 1,697 € |
| 057 097 110036 | PSR-36 SİRAL REKORU | 1 ad. | | 2,411 € |
| 057 097 110048 | PSR-48 SİRAL REKORU | 1 ad. | | 3,125 € |

| Kod | Açıklama / Stok Cinsi | Amb. Kutu/Bağ | Amb. Koli/Çyl | FİYAT |
|------------------------------|-----------------------------------|---------------|---------------|---------|
| POLYAMİD SİRAL REKORU | | | | |
| 057 097 120007 | PSRD-7 SİRAL REKORU 90° DİRSEK | 1 ad. | | 0,833 € |
| 057 097 120009 | PSRD-9 SİRAL REKORU 90° DİRSEK | 1 ad. | | 0,893 € |
| 057 097 120011 | PSRD-11 SİRAL REKORU 90° DİRSEK | 1 ad. | | 0,982 € |
| 057 097 120135 | PSRD-13,5 SİRAL REKORU 90° DİRSEK | 1 ad. | | 1,161 € |
| 057 097 120016 | PSRD-16 SİRAL REKORU 90° DİRSEK | 1 ad. | | 1,339 € |
| 057 097 120021 | PSRD-21 SİRAL REKORU 90° DİRSEK | 1 ad. | | 2,143 € |
| 057 097 120029 | PSRD-29 SİRAL REKORU 90° DİRSEK | 1 ad. | | 2,768 € |
| 057 097 120036 | PSRD-36 SİRAL REKORU 90° DİRSEK | 1 ad. | | 3,750 € |



| Kod | Açıklama / Stok Cinsi | Amb. Kutu/Bağ | Amb. Koli/Çyl | FİYAT |
|---|------------------------------------|---------------|---------------|-------|
| HAFİF SERİ PVC. SİRALLER (ALEV YAYMAYAN) | | | | |
| 001 020 010016 00 17 | 16 Ø A.YAYMAYAN SİRAL (HAFİF SERİ) | 100 mt. | 500 | 0,665 |
| 001 020 010020 00 17 | 20 Ø A.YAYMAYAN SİRAL (HAFİF SERİ) | 100 mt. | 500 | 0,971 |
| 001 020 010025 00 17 | 25 Ø A.YAYMAYAN SİRAL (HAFİF SERİ) | 50 mt. | 250 | 1,300 |
| 001 020 010032 00 17 | 32 Ø A.YAYMAYAN SİRAL (HAFİF SERİ) | 50 mt. | 250 | 1,672 |

| Kod | Açıklama / Stok Cinsi | Amb. Kutu/Bağ | Amb. Koli/Çyl | FİYAT |
|---|-----------------------------------|---------------|---------------|-------|
| AĞIR SERİ PVC. SİRALLER (ALEV YAYMAYAN) (750N) | | | | |
| 001 020 000016 00 11 | 16 Ø A.YAYMAYAN SİRAL (AĞIR SERİ) | 100 mt. | 500 | 0,700 |
| 001 020 000020 00 11 | 20 Ø A.YAYMAYAN SİRAL (AĞIR SERİ) | 100 mt. | 500 | 1,035 |
| 001 020 000025 00 11 | 25 Ø A.YAYMAYAN SİRAL (AĞIR SERİ) | 50 mt. | 250 | 1,388 |
| 001 020 000032 00 11 | 32 Ø A.YAYMAYAN SİRAL (AĞIR SERİ) | 50 mt. | 250 | 1,847 |

| Kod | Açıklama / Stok Cinsi | Amb. Kutu/Bağ | Amb. Koli/Çyl | FİYAT |
|--|------------------------------------|---------------|---------------|-------|
| HAFİF SERİ PVC. TELLİ SİRALLER (A.YAYMAYAN)(320N) | | | | |
| 001 020 120016 00 11 | 16 Ø TELLİ A.YAYMAYAN (HAFİF SERİ) | 100 mt. | 500 | 0,805 |
| 001 020 120020 00 11 | 20 Ø TELLİ A.YAYMAYAN (HAFİF SERİ) | 100 mt. | 500 | 1,064 |
| 001 020 120025 00 11 | 25 Ø TELLİ A.YAYMAYAN (HAFİF SERİ) | 50 mt. | 250 | 1,434 |
| 001 020 120032 00 11 | 32 Ø TELLİ A.YAYMAYAN (HAFİF SERİ) | 50 mt. | 250 | 1,897 |

| Kod | Açıklama / Stok Cinsi | Amb. Kutu/Bağ | Amb. Koli/Çyl | FİYAT |
|---|-----------------------------------|---------------|---------------|-------|
| AĞIR SERİ PVC. TELLİ SİRALLER (A.YAYMAYAN)(750N) | | | | |
| 001 020 100016 00 11 | 16 Ø TELLİ A.YAYMAYAN (AĞIR SERİ) | 100 mt. | 500 | 0,805 |
| 001 020 100020 00 11 | 20 Ø TELLİ A.YAYMAYAN (AĞIR SERİ) | 100 mt. | 500 | 1,175 |
| 001 020 100025 00 11 | 25 Ø TELLİ A.YAYMAYAN (AĞIR SERİ) | 50 mt. | 250 | 1,545 |
| 001 020 100032 00 11 | 32 Ø TELLİ A.YAYMAYAN (AĞIR SERİ) | 50 mt. | 250 | 2,008 |

| Kod | Açıklama / Stok Cinsi | Amb. Kutu/Bağ | Amb. Koli/Çyl | FİYAT |
|--|-------------------------------------|---------------|---------------|-------|
| HALOJEN FREE SİRALLER (A.YAYAN)(320N) | | | | |
| 001 020 140016 00 17 | 16 Ø HALOJEN FREE SPR. (ALEV YAYAN) | 100 mt. | 500 | 0,598 |
| 001 020 140020 00 17 | 20 Ø HALOJEN FREE SPR. (ALEV YAYAN) | 100 mt. | 500 | 0,703 |
| 001 020 140025 00 17 | 25 Ø HALOJEN FREE SPR. (ALEV YAYAN) | 50 mt. | 250 | 1,005 |
| 001 020 140032 00 17 | 32 Ø HALOJEN FREE SPR. (ALEV YAYAN) | 50 mt. | 250 | 1,293 |
| 001 020 140040 00 17 | 40 Ø HALOJEN FREE SPR. (ALEV YAYAN) | 25 mt. | 125 | 2,009 |
| 001 020 140050 00 17 | 50 Ø HALOJEN FREE SPR. (ALEV YAYAN) | 25 mt. | 125 | 2,532 |

| Kod | Açıklama / Stok Cinsi | Amb. Kutu/Bağ | Amb. Koli/Çyl | FİYAT |
|--|-----------------------------------|---------------|---------------|-------|
| HALOJEN FREE SİRALLER TELLİ (A.YAYAN)(320N) | | | | |
| 001 020 141016 00 17 | 16 Ø H.FREE SİRAL(A.YAYAN)(TELLİ) | 100 mt. | 500 | 0,707 |
| 001 020 141020 00 17 | 20 Ø H.FREE SİRAL(A.YAYAN)(TELLİ) | 100 mt. | 500 | 0,888 |
| 001 020 141025 00 17 | 25 Ø H.FREE SİRAL(A.YAYAN)(TELLİ) | 50 mt. | 250 | 1,189 |
| 001 020 141032 00 17 | 32 Ø H.FREE SİRAL(A.YAYAN)(TELLİ) | 50 mt. | 250 | 1,390 |
| 001 020 141040 00 17 | 40 Ø H.FREE SİRAL(A.YAYAN)(TELLİ) | 25 mt. | 125 | 2,194 |

| Kod | Açıklama / Stok Cinsi | Amb. Kutu/Bağ | Amb. Koli/Çyl | FİYAT |
|---|------------------------------------|---------------|---------------|-------|
| HALOJEN FREE SİRALLER (A.YAYMAYAN)(320N) | | | | |
| 001 020 150016 00 17 | 16 Ø HALOJEN FREE SPR.(A.YAYMAYAN) | 100 mt. | 500 | 0,863 |
| 001 020 150020 00 17 | 20 Ø HALOJEN FREE SPR.(A.YAYMAYAN) | 100 mt. | 500 | 0,958 |
| 001 020 150025 00 17 | 25 Ø HALOJEN FREE SPR.(A.YAYMAYAN) | 50 mt. | 250 | 1,339 |
| 001 020 150032 00 17 | 32 Ø HALOJEN FREE SPR.(A.YAYMAYAN) | 50 mt. | 250 | 1,607 |
| 001 020 150040 00 17 | 40 Ø HALOJEN FREE SPR.(A.YAYMAYAN) | 25 mt. | 125 | 2,679 |
| 001 020 150050 00 17 | 50 Ø HALOJEN FREE SPR.(A.YAYMAYAN) | 25 mt. | 125 | 3,375 |

| Kod | Açıklama / Stok Cinsi | Amb. Kutu/Bağ | Amb. Koli/Çyl | FİYAT |
|---|-------------------------------------|---------------|---------------|-------|
| HALOJEN FREE SİRALLER TELLİ (A.YAYMAYAN)(320N) | | | | |
| 001 020 151016 00 17 | 16 Ø H.FREE SPR.(A.YAYMAYAN)(TELLİ) | 100 mt. | 500 | 0,967 |
| 001 020 151020 00 17 | 20 Ø H.FREE SPR.(A.YAYMAYAN)(TELLİ) | 100 mt. | 500 | 1,149 |
| 001 020 151025 00 17 | 25 Ø H.FREE SPR.(A.YAYMAYAN)(TELLİ) | 50 mt. | 250 | 1,551 |
| 001 020 151032 00 17 | 32 Ø H.FREE SPR.(A.YAYMAYAN)(TELLİ) | 50 mt. | 250 | 1,819 |
| 001 020 151040 00 17 | 40 Ø H.FREE SPR.(A.YAYMAYAN)(TELLİ) | 25 mt. | 125 | 2,890 |

| Kod | Açıklama / Stok Cinsi | Amb. Kutu/Bağ | Amb. Koli/Çyl | FİYAT |
|-----------------------------|--------------------------------------|---------------|---------------|----------|
| KABLO TOPLAMA SİRALİ | | | | |
| 888 020 900003 | R1034 16 MM KAB.TOP SPR.(1,5M VAK) | 1 ad. | 40 | 3,360 \$ |
| 888 020 900006 | R1035 22 MM KAB.TOP SPR.(1,5M VAK)</ | | | |

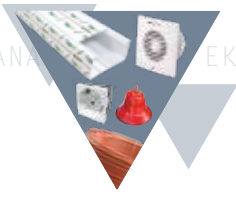

| Kod | Açıklama / Stok Cinsi | Amb. Kutu/Bağ | Amb. Koli/Çyl | FİYAT |
|-----|-----------------------|---------------|---------------|-------|
|-----|-----------------------|---------------|---------------|-------|

EKO SERİSİ ÇELİK SİRALLER

| | | | | |
|----------------------|----------------------------------|--------|-----|-------|
| 001 054 150009 00 66 | 9 Ø EKO ÇELİK SİRALLER | 50 mt. | 200 | 0,885 |
| 001 054 150011 00 66 | 11 Ø EKO ÇELİK SİRALLER (3/8") | 50 mt. | 200 | 1,034 |
| 001 054 150014 00 66 | 14 Ø EKO ÇELİK SİRALLER (1/2") | 50 mt. | 200 | 1,221 |
| 001 054 150016 00 66 | 16 Ø EKO ÇELİK SİRALLER | 50 mt. | 200 | 1,297 |
| 001 054 150018 00 66 | 18 Ø EKO ÇELİK SİRALLER (3/4") | 50 mt. | 200 | 1,433 |
| 001 054 150021 00 66 | 21 Ø EKO ÇELİK SİRALLER | 50 mt. | 200 | 1,641 |
| 001 054 150026 00 66 | 26 Ø EKO ÇELİK SİRALLER (1") | 25 mt. | 100 | 2,572 |
| 001 054 150029 00 66 | 29 Ø EKO ÇELİK SİRALLER (1 1/4") | 25 mt. | 100 | 2,974 |
| 001 054 150032 00 66 | 32 Ø EKO ÇELİK SİRALLER | 25 mt. | 100 | 3,080 |
| 001 054 150037 00 66 | 37 Ø EKO ÇELİK SİRALLER (1 1/2") | 25 mt. | 100 | 3,610 |
| 001 054 150042 00 66 | 42 Ø EKO ÇELİK SİRALLER | 25 mt. | 100 | 4,431 |
| 001 054 150050 00 66 | 50 Ø EKO ÇELİK SİRALLER (2") | 25 mt. | 100 | 4,853 |

EKO SERİSİ ÇELİK SİRALLER (KLAVUZ TELLİ)

| | | | | |
|----------------------|----------------------------------|--------|-----|-------|
| 001 054 221011 00 66 | 11 Ø EKO Ç. SİRAL(TELLİ)(3/8") | 50 mt. | 200 | 1,144 |
| 001 054 221014 00 66 | 14 Ø EKO Ç. SİRAL(TELLİ)(1/2") | 50 mt. | 200 | 1,338 |
| 001 054 221016 00 66 | 16 Ø EKO Ç. SİRAL(TELLİ) | 50 mt. | 200 | 1,495 |
| 001 054 221018 00 66 | 18 Ø EKO Ç. SİRAL(TELLİ) (3/4") | 50 mt. | 200 | 1,584 |
| 001 054 221021 00 66 | 21 Ø EKO Ç. SİRAL(TELLİ) | 50 mt. | 200 | 1,675 |
| 001 054 221026 00 66 | 26 Ø EKO Ç. SİRAL(TELLİ)(1") | 25 mt. | 100 | 2,632 |
| 001 054 221029 00 66 | 29 Ø EKO Ç. SİRAL(TELLİ)(1 1/4") | 25 mt. | 100 | 3,034 |
| 001 054 221032 00 66 | 32 Ø EKO Ç. SİRAL(TELLİ) | 25 mt. | 100 | 3,110 |
| 001 054 221037 00 66 | 37 Ø EKO Ç. SİRAL(TELLİ)(1 1/2") | 25 mt. | 100 | 3,932 |
| 001 054 221042 00 66 | 42 Ø EKO Ç. SİRAL(TELLİ) | 25 mt. | 100 | 4,834 |
| 001 054 221050 00 66 | 50 Ø EKO Ç. SİRAL(TELLİ) (2") | 25 mt. | 100 | 4,913 |

EKO SERİSİ İZOLELİ ÇELİK SİRALLER

| | | | | |
|----------------------|------------------------------------|--------|--|-------|
| 001 054 160009 00 11 | 9 Ø EKO İZOLELİ Ç. SİRAL | 50 mt. | | 1,265 |
| 001 054 160011 00 11 | 11 Ø EKO İZOLELİ Ç. SİRAL(3/8") | 50 mt. | | 1,375 |
| 001 054 160014 00 11 | 14 Ø EKO İZOLELİ Ç. SİRAL(1/2") | 50 mt. | | 1,540 |
| 001 054 160016 00 11 | 16 Ø EKO İZOLELİ Ç. SİRAL | 50 mt. | | 1,650 |
| 001 054 160018 00 11 | 18 Ø EKO İZOLELİ Ç. SİRAL(3/4") | 50 mt. | | 2,118 |
| 001 054 160021 00 11 | 21 Ø EKO İZOLELİ Ç. SİRAL | 50 mt. | | 2,305 |
| 001 054 160026 00 11 | 26 Ø EKO İZOLELİ Ç. SİRAL(1") | 25 mt. | | 3,025 |
| 001 054 160029 00 11 | 29 Ø EKO İZOLELİ Ç. SİRAL(1 1/4") | 25 mt. | | 3,707 |
| 001 054 160032 00 11 | 32 Ø EKO İZOLELİ Ç. SİRAL | 25 mt. | | 4,090 |
| 001 054 160037 00 11 | 37 Ø EKO İZOLELİ Ç. SİRAL (1 1/2") | 25 mt. | | 4,467 |
| 001 054 160042 00 11 | 42 Ø EKO İZOLELİ Ç. SİRAL | 25 mt. | | 5,682 |
| 001 054 160050 00 11 | 50 Ø EKO İZOLELİ Ç. SİRAL(2") | 25 mt. | | 6,141 |

EKO SERİSİ İZOLELİ ÇELİK SİRALLER (KLAVUZ TELLİ)

| | | | | |
|----------------------|-------------------------------------|--------|--|-------|
| 001 054 231011 00 11 | 11 Ø EKO İZO.Ç. SPR.(TELLİ)(3/8") | 50 mt. | | 1,523 |
| 001 054 231014 00 11 | 14 Ø EKO İZO.Ç. SPR.(TELLİ)(1/2") | 50 mt. | | 1,608 |
| 001 054 231016 00 11 | 16 Ø EKO İZO.Ç. SPR. (TELLİ) | 50 mt. | | 1,793 |
| 001 054 231018 00 11 | 18 Ø EKO İZO.Ç. SPR.(TELLİ) (3/4") | 50 mt. | | 1,964 |
| 001 054 231021 00 11 | 21 Ø EKO İZO.Ç. SPR.(TELLİ) | 50 mt. | | 2,175 |
| 001 054 231026 00 11 | 26 Ø EKO İZO.Ç. SPR.(TELLİ)(1") | 25 mt. | | 3,113 |
| 001 054 231029 00 11 | 29 Ø EKO İZO.Ç. SPR.(TELLİ)(1 1/4") | 25 mt. | | 3,767 |
| 001 054 231032 00 11 | 32 Ø EKO İZO.Ç. SPR.(TELLİ) | 25 mt. | | 4,140 |
| 001 054 231037 00 11 | 37 Ø EKO İZO.Ç. SPR.(TELLİ)(1 1/2") | 25 mt. | | 4,354 |
| 001 054 231042 00 11 | 42 Ø EKO İZO.Ç. SPR.(TELLİ) | 25 mt. | | 5,687 |
| 001 054 231050 00 11 | 50 Ø EKO İZO.Ç. SPR.(TELLİ) (2") | 25 mt. | | 6,380 |

SÜPER ETANJ PLASTİK RAKORLAR

| | | | | |
|----------------|-----------------------|-------|--|-------|
| 010 097 000007 | PG-7 PLASTİK REKOR | 1 ad. | | 0,469 |
| 010 097 000009 | PG-9 PLASTİK REKOR | 1 ad. | | 0,563 |
| 010 097 000011 | PG-11 PLASTİK REKOR | 1 ad. | | 0,670 |
| 010 097 000135 | PG-13,5 PLASTİK REKOR | 1 ad. | | 0,744 |
| 010 097 000016 | PG-16 PLASTİK REKOR | 1 ad. | | 0,893 |
| 010 097 000021 | PG-21 PLASTİK REKOR | 1 ad. | | 1,280 |
| 010 097 000029 | PG-29 PLASTİK REKOR | 1 ad. | | 2,024 |
| 010 097 000036 | PG-36 PLASTİK REKOR | 1 ad. | | 3,918 |
| 010 097 000042 | PG-42 PLASTİK REKOR | 1 ad. | | 5,240 |
| 010 097 000048 | PG-48 PLASTİK REKOR | 1 ad. | | 5,816 |

SÜPER ETANJ METAL RAKORLAR

| | | | | |
|----------------|---------------------|---------|------|---------|
| 057 097 100007 | PG-7 METAL REKOR | 450 ad. | 4500 | 6,050 |
| 057 097 100009 | PG-9 METAL REKOR | 300 ad. | 3000 | 6,050 |
| 057 097 100011 | PG-11 METAL REKOR | 200 ad. | 2000 | 7,109 |
| 057 097 100135 | PG-13,5 METAL REKOR | 175 ad. | 1750 | 8,470 |
| 057 097 100016 | PG-16 METAL REKOR | 125 ad. | 1250 | 9,075 |
| 057 097 100021 | PG-21 METAL REKOR | 75 ad. | 750 | 14,066 |
| 057 097 100029 | PG-29 METAL REKOR | 40 ad. | 400 | 27,225 |
| 057 097 100036 | PG-36 METAL REKOR | 20 ad. | 200 | 55,963 |
| 057 097 100042 | PG-42 METAL REKOR | 15 ad. | 150 | 90,750 |
| 057 097 100048 | PG-48 METAL REKOR | 12 ad. | 120 | 105,875 |

PİRİNÇ RAKORLAR (NORMAL)

| | | | | |
|----------------|------------------------------|-------|--|--------|
| 012 097 010009 | 9 Ø PİRİNÇ RAKOR (NORMAL) | 1 ad. | | 4,911 |
| 012 097 010011 | 11 Ø PİRİNÇ RAKOR (NORMAL) | 1 ad. | | 5,953 |
| 012 097 010135 | 13,5 Ø PİRİNÇ RAKOR (NORMAL) | 1 ad. | | 7,441 |
| 012 097 010016 | 16 Ø PİRİNÇ RAKOR (NORMAL) | 1 ad. | | 8,929 |
| 012 097 010021 | 21 Ø PİRİNÇ RAKOR (NORMAL) | 1 ad. | | 13,394 |
| 012 097 010029 | 29 Ø PİRİNÇ RAKOR (NORMAL) | 1 ad. | | 22,324 |
| 012 097 010036 | 36 Ø PİRİNÇ RAKOR (NORMAL) | 1 ad. | | 31,253 |
| 012 097 010042 | 42 Ø PİRİNÇ RAKOR (NORMAL) | 1 ad. | | 37,206 |

| Kod | Açıklama / Stok Cinsi | Amb. Kutu/Bağ | Amb. Koli/Çyl | FİYAT |
|-----|-----------------------|---------------|---------------|-------|
|-----|-----------------------|---------------|---------------|-------|

MEKS SERİSİ ÇELİK SİRALLER

| | | | | |
|----------------------|------------------------------|--------|-----|-------|
| 001 054 120009 00 66 | 9 Ø ÇELİK SİRALLER | 50 mt. | 200 | 1,040 |
| 001 054 120011 00 66 | 11 Ø ÇELİK SİRALLER (3/8") | 50 mt. | 200 | 1,132 |
| 001 054 120014 00 66 | 14 Ø ÇELİK SİRALLER (1/2") | 50 mt. | 200 | 1,331 |
| 001 054 120016 00 66 | 16 Ø ÇELİK SİRALLER | 50 mt. | 200 | 1,455 |
| 001 054 120018 00 66 | 18 Ø ÇELİK SİRALLER (3/4") | 50 mt. | 200 | 1,573 |
| 001 054 120021 00 66 | 21 Ø ÇELİK SİRALLER | 50 mt. | 200 | 1,755 |
| 001 054 120026 00 66 | 26 Ø ÇELİK SİRALLER (1") | 25 mt. | 100 | 2,806 |
| 001 054 120029 00 66 | 29 Ø ÇELİK SİRALLER (1 1/4") | 25 mt. | 100 | 3,304 |
| 001 054 120037 00 66 | 37 Ø ÇELİK SİRALLER (1 1/2") | 25 mt. | 100 | 4,003 |
| 001 054 120042 00 66 | 42 Ø ÇELİK SİRALLER | 25 mt. | 100 | 4,901 |
| 001 054 120050 00 66 | 50 Ø ÇELİK SİRALLER (2") | 25 mt. | 100 | 5,348 |
| 001 054 120063 00 66 | 63 Ø ÇELİK SİRALLER | 15 mt. | 60 | 6,988 |

MEKS SERİSİ ÇELİK SİRALLER (KLAVUZ TELLİ)

| | | | | |
|----------------------|------------------------------|--------|-----|-------|
| 001 054 121011 00 66 | 11 Ø Ç. SİRAL(TELLİ)(3/8") | 50 mt. | 200 | 1,336 |
| 001 054 121014 00 66 | 14 Ø Ç. SİRAL(TELLİ)(1/2") | 50 mt. | 200 | 1,510 |
| 001 054 121016 00 66 | 16 Ø Ç. SİRAL(TELLİ) | 50 mt. | 200 | 1,611 |
| 001 054 121018 00 66 | 18 Ø Ç. SİRAL(TELLİ) (3/4") | 50 mt. | 200 | 1,759 |
| 001 054 121021 00 66 | 21 Ø Ç. SİRAL(TELLİ) | 50 mt. | 200 | 1,848 |
| 001 054 121026 00 66 | 26 Ø Ç. SİRAL(TELLİ)(1") | 25 mt. | 100 | 2,707 |
| 001 054 121029 00 66 | 29 Ø Ç. SİRAL(TELLİ)(1 1/4") | 25 mt. | 100 | 3,075 |
| 001 054 121037 00 66 | 37 Ø Ç. SİRAL(TELLİ)(1 1/2") | 25 mt. | 100 | 4,017 |
| 001 054 121042 00 66 | 42 Ø Ç. SİRAL(TELLİ) | 25 mt. | 100 | 4,872 |
| 001 054 121050 00 66 | 50 Ø Ç. SİRAL(TELLİ) (2") | 25 mt. | 100 | 5,022 |
| 001 054 121063 00 66 | 63 Ø Ç. SİRAL(TELLİ) | 15 mt. | 60 | 7,079 |

MEKS SERİSİ İZOLELİ ÇELİK SİRALLER

| | | | | |
|----------------------|--------------------------------|--------|--|-------|
| 001 054 130009 00 11 | 9 Ø İZOLELİ Ç. SİRAL | 50 mt. | | 1,395 |
| 001 054 130011 00 11 | 11 Ø İZOLELİ Ç. SİRAL(3/8") | 50 mt. | | 1,521 |
| 001 054 130014 00 11 | 14 Ø İZOLELİ Ç. SİRAL(1/2") | 50 mt. | | 1,663 |
| 001 054 130016 00 11 | 16 Ø İZOLELİ Ç. SİRAL | 50 mt. | | 1,777 |
| 001 054 130018 00 11 | 18 Ø İZOLELİ Ç. SİRAL(3/4") | 50 mt. | | 2,235 |
| 001 054 130026 00 11 | 26 Ø İZOLELİ Ç. SİRAL(1") | 25 mt. | | 3,295 |
| 001 054 130029 00 11 | 29 Ø İZOLELİ Ç. SİRAL(1 1/4") | 25 mt. | | 3,721 |
| 001 054 130037 00 11 | 37 Ø İZOLELİ Ç. SİRAL (1 1/2") | 25 mt. | | 4,588 |
| 001 054 130042 00 11 | 40 Ø İZOLELİ Ç. SİRAL | 25 mt. | | 5,775 |
| 001 054 130050 00 11 | 50 Ø İZOLELİ Ç. SİRAL(2") | 25 mt. | | 6,648 |
| 001 054 130063 00 11 | 63 Ø İZOLELİ ÇELİK SİRAL | 15 mt. | | 9,123 |

MEKS SERİSİ İZOLELİ ÇELİK SİRALLER (KLAVUZ TELLİ)

| | | | | |
|----------------------|---------------------------------|--------|--|-------|
| 001 054 140011 00 11 | 11 Ø İZO.Ç. SPR.(TELLİ)(3/8") | 50 mt. | | 1,712 |
| 001 054 140014 00 11 | 14 Ø İZO.Ç. SPR.(TELLİ)(1/2") | 50 mt. | | 1,740 |
| 001 054 140016 00 11 | 16 Ø İZO.Ç. SPR. (TELLİ) | 50 mt. | | 1,865 |
| 001 054 140018 00 11 | 18 Ø İZO.Ç. SPR.(TELLİ) (3/4") | 50 mt. | | 2,082 |
| 001 054 140026 00 11 | 26 Ø İZO.Ç. SPR.(TELLİ)(1") | 50 mt. | | 3,350 |
| 001 054 140029 00 11 | 29 Ø İZO.Ç. SPR.(TELLİ)(1 1/4") | 50 mt. | | 3,882 |
| 001 054 140037 00 11 | 37 Ø İZO.Ç. SPR.(TELLİ)(1 1/2") | 50 mt. | | 4,528 |
| 001 054 140042 00 11 | 42 Ø İZO.Ç. SPR.(TELLİ) | 50 mt. | | 5,830 |
| 001 054 140050 00 11 | 50 Ø İZO.Ç. SPR.(TELLİ) (2") | 50 mt. | | 6,722 |
| 001 054 140063 00 11 | 63 Ø İZO.Ç. SPR.(TELLİ) | 15 mt. | | 9,184 |

NİKEL KAPLI ÇELİK SİRAL REKORU

| | | | | |
|----------------|-----------------------------|---------|--|--------|
| 012 097 030009 | CLK- 9 ÇELİK SİRAL REKORU | 150 ad. | | 6,965 |
| 012 097 030011 | CLK-11 ÇELİK SİRAL REKORU | 175 ad. | | 8,929 |
| 012 097 030014 | CLK-13,5 ÇELİK SİRAL REKORU | 90 ad. | | 9,822 |
| 012 097 030016 | CLK-16 ÇELİK SİRAL REKORU | 75 ad. | | 11,459 |
| 012 097 030018 | CLK-18 ÇELİK SİRAL REKORU | 80 ad. | | 13,394 |
| 012 097 030026 | CLK-26 ÇELİK SİRAL REKORU | 30 ad. | | 18,156 |
| 012 097 030037 | CLK-37 ÇELİK SİRAL REKORU | 9 ad. | | 39,289 |

PLASTİK RAKOR SOMUNLARI

| | | | | |
|----------------|---------------|---------|--|-------|
| 010 098 020007 | PG-7 SOMUN | 250 ad. | | 0,200 |
| 010 098 020009 | PG-9 SOMUN | 250 ad. | | 0,236 |
| 010 098 020011 | PG-11 SOMUN | 250 ad. | | 0,254 |
| 010 098 020135 | PG-13,5 SOMUN | 250 ad. | | 0,272 |
| 010 098 020016 | PG-16 SOMUN | 250 ad. | | 0,303 |
| 010 098 020021 | PG-21 SOMUN | 250 ad. | | 0,363 |
| 010 098 020029 | PG-29 SOMUN | 150 ad. | | 0,575 |
| 010 098 020036 | PG-36 SOMUN | 100 ad. | | 1,271 |

KÖR TAPA

| | | | | |
|----------------|------------------|---------|--|-------|
| 012 098 000007 | PG 7 KÖR TAPA | 250 ad. | | 0,454 |
| 012 098 000009 | PG 9 KÖR TAPA | 250 ad. | | 0,584 |
| 012 098 000011 | PG 11 KÖR TAPA | 250 ad. | | 0,614 |
| 012 098 000135 | PG 13,5 KÖR TAPA | 250 ad. | | 0,605 |
| 012 098 000016 | PG 16 KÖR TAPA | 250 ad. | | 0,756 |
| 012 098 000021 | PG 21 KÖR TAPA | 250 ad. | | 0,908 |
| 012 098 000029 | PG 29 KÖR TAPA | 150 ad. | | 1,664 |
| 012 098 000036 | PG 36 KÖR TAPA | 100 ad. | | 2,571 |

PİRİNÇ RAKORLAR (KELEPÇELİ)

| | | | | |
|----------------|---------------------------------|-------|--|--------|
| 012 097 020009 | 9 Ø PİRİNÇ RAKOR (KELEPÇELİ) | 1 ad. | | 8,929 |
| 012 097 020011 | 11 Ø PİRİNÇ RAKOR (KELEPÇELİ) | 1 ad. | | 10,418 |
| 012 097 020135 | 13,5 Ø PİRİNÇ RAKOR (KELEPÇELİ) | 1 ad. | | 11,906 |
| 012 097 020016 | 16 Ø PİRİNÇ RAKOR (KELEPÇELİ) | 1 ad. | | 13,394 |
| 012 097 020021 | 21 Ø PİRİNÇ RAKOR (KELEPÇELİ) | 1 ad. | | 17,859 |
| 012 097 020029 | 29 Ø PİRİNÇ RAKOR (KELEPÇELİ) | 1 ad. | | 29,765 |
| 012 097 020036 | 36 Ø PİRİNÇ RAKOR (KELEPÇELİ) | 1 ad. | | 50,600 |
| 012 097 020042 | 42 Ø PİRİNÇ RAKOR (KELEPÇELİ) | 1 ad. | | 68,459 |

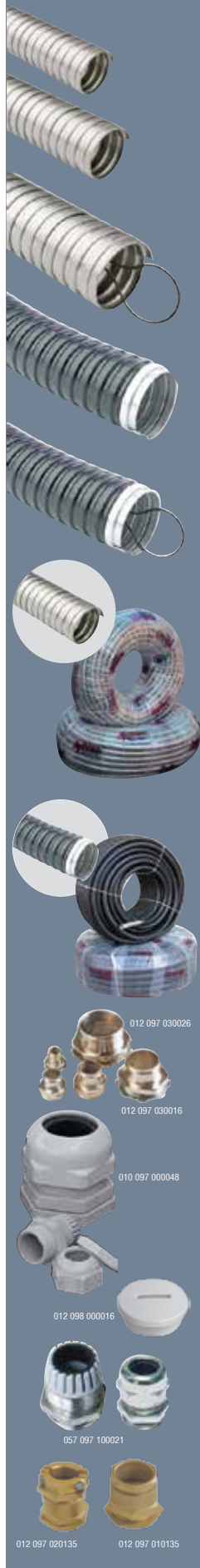

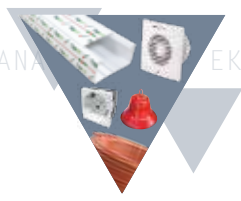

| Kod | Açıklama / Stok Cinsi | Amb. Kutu/Bağ | Amb. Koli/Çvl | FİYAT |
|-----|-----------------------|---------------|---------------|-------|
|-----|-----------------------|---------------|---------------|-------|

SİBOR SERİSİ HALOGEN FREE TURUNCU BORULAR (6 ATÜ) (ALEV YAYAN)(125N)

| | | | |
|----------------------|---------------------------------------|---------|-------|
| 001 165 706014 00 12 | 14/6 ATÜ BORU (H.FREE)(A.YAYAN) SİBOR | 100 mt. | 0,679 |
| 001 165 706016 00 12 | 16/6 ATÜ BORU (H.FREE)(A.YAYAN) SİBOR | 100 mt. | 0,835 |
| 001 165 706018 00 12 | 18/6 ATÜ BORU (H.FREE)(A.YAYAN) SİBOR | 100 mt. | 1,004 |
| 001 165 706020 00 12 | 20/6 ATÜ BORU (H.FREE)(A.YAYAN) SİBOR | 100 mt. | 1,121 |
| 001 165 706025 00 12 | 25/6 ATÜ BORU (H.FREE)(A.YAYAN) SİBOR | 100 mt. | 1,489 |
| 001 165 706032 00 12 | 32/6 ATÜ BORU (H.FREE)(A.YAYAN) SİBOR | 100 mt. | 2,374 |
| 001 165 706037 00 12 | 37/6 ATÜ BORU (H.FREE)(A.YAYAN) SİBOR | 100 mt. | 2,967 |
| 001 165 706040 00 12 | 40/6 ATÜ BORU (H.FREE)(A.YAYAN) SİBOR | 100 mt. | 3,441 |
| 001 165 706050 00 12 | 50/6 ATÜ BORU (H.FREE)(A.YAYAN) SİBOR | 100 mt. | 4,866 |

SİBOR SERİSİ H.FREE BORULAR (10 ATÜ) (A.YAYAN)(320N)

| | | | |
|----------------------|--|---------|-------|
| 001 165 710014 00 12 | 14/10 ATÜ BORU (H.FREE)(A.YAYAN) SİBOR | 100 mt. | 0,778 |
| 001 165 710016 00 12 | 16/10 ATÜ BORU (H.FREE)(A.YAYAN) SİBOR | 100 mt. | 0,916 |
| 001 165 710018 00 12 | 18/10 ATÜ BORU (H.FREE)(A.YAYAN) SİBOR | 100 mt. | 1,146 |
| 001 165 710020 00 12 | 20/10 ATÜ BORU (H.FREE)(A.YAYAN) SİBOR | 100 mt. | 1,368 |
| 001 165 710025 00 12 | 25/10 ATÜ BORU (H.FREE)(A.YAYAN) SİBOR | 100 mt. | 1,736 |
| 001 165 710032 00 12 | 32/10 ATÜ BORU (H.FREE)(A.YAYAN) SİBOR | 100 mt. | 2,779 |
| 001 165 710037 00 12 | 37/10 ATÜ BORU (H.FREE)(A.YAYAN) SİBOR | 100 mt. | 3,501 |
| 001 165 710040 00 12 | 40/10 ATÜ BORU (H.FREE)(A.YAYAN) SİBOR | 100 mt. | 4,526 |
| 001 165 710050 00 12 | 50/10 ATÜ BORU (H.FREE)(A.YAYAN) SİBOR | 100 mt. | 6,006 |

SİBOR SERİSİ H.FREE BORULAR (6 ATÜ) (A.YAYMAYAN)(125N)

| | | | |
|----------------------|--|---------|-------|
| 001 165 206014 00 12 | 14/6 ATÜ BORU (H.FREE)(A.YAYMAYAN) SİBOR | 100 mt. | 1,146 |
| 001 165 206016 00 12 | 16/6 ATÜ BORU (H.FREE)(A.YAYMAYAN) SİBOR | 100 mt. | 1,326 |
| 001 165 206018 00 12 | 18/6 ATÜ BORU (H.FREE)(A.YAYMAYAN) SİBOR | 100 mt. | 1,493 |
| 001 165 206020 00 12 | 20/6 ATÜ BORU (H.FREE)(A.YAYMAYAN) SİBOR | 100 mt. | 1,709 |
| 001 165 206025 00 12 | 25/6 ATÜ BORU (H.FREE)(A.YAYMAYAN) SİBOR | 100 mt. | 2,357 |
| 001 165 206032 00 12 | 32/6 ATÜ BORU (H.FREE)(A.YAYMAYAN) SİBOR | 100 mt. | 3,929 |
| 001 165 206037 00 12 | 37/6 ATÜ BORU (H.FREE)(A.YAYMAYAN) SİBOR | 100 mt. | 4,911 |
| 001 165 206040 00 12 | 40/6 ATÜ BORU (H.FREE)(A.YAYMAYAN) SİBOR | 100 mt. | 5,304 |
| 001 165 206050 00 12 | 50/6 ATÜ BORU (H.FREE)(A.YAYMAYAN) SİBOR | 100 mt. | 8,054 |

SİBOR SERİSİ H.FREE BORULAR (10 ATÜ) (A.YAYMAYAN)(320N)

| | | | |
|----------------------|---|---------|-------|
| 001 165 210014 00 12 | 14/10 ATÜ BORU (H.FREE)(A.YAYMAYAN) SİBOR | 100 mt. | 1,277 |
| 001 165 210016 00 12 | 16/10 ATÜ BORU (H.FREE)(A.YAYMAYAN) SİBOR | 100 mt. | 1,434 |
| 001 165 210018 00 12 | 18/10 ATÜ BORU (H.FREE)(A.YAYMAYAN) SİBOR | 100 mt. | 1,747 |
| 001 165 210020 00 12 | 20/10 ATÜ BORU (H.FREE)(A.YAYMAYAN) SİBOR | 100 mt. | 2,161 |
| 001 165 210025 00 12 | 25/10 ATÜ BORU (H.FREE)(A.YAYMAYAN) SİBOR | 100 mt. | 2,711 |
| 001 165 210032 00 12 | 32/10 ATÜ BORU (H.FREE)(A.YAYMAYAN) SİBOR | 100 mt. | 4,322 |
| 001 165 210037 00 12 | 37/10 ATÜ BORU (H.FREE)(A.YAYMAYAN) SİBOR | 100 mt. | 5,795 |
| 001 165 210040 00 12 | 40/10 ATÜ BORU (H.FREE)(A.YAYMAYAN) SİBOR | 100 mt. | 7,229 |
| 001 165 210050 00 12 | 50/10 ATÜ BORU (H.FREE)(A.YAYMAYAN) SİBOR | 100 mt. | 9,921 |

POLİETİLEN SİYAH YERALTI BORULAR (450N)

| | | | |
|----------------------|----------------------------------|---------|--------|
| 001 165 406014 00 11 | 14/6 ATÜ POLİETİLEN BORU (SİYAH) | 100 mt. | 0,591 |
| 001 165 406016 00 11 | 16/6 ATÜ POLİETİLEN BORU (SİYAH) | 100 mt. | 0,728 |
| 001 165 406018 00 11 | 18/6 ATÜ POLİETİLEN BORU (SİYAH) | 100 mt. | 0,845 |
| 001 165 406020 00 11 | 20/6 ATÜ POLİETİLEN BORU (SİYAH) | 100 mt. | 1,004 |
| 001 165 406025 00 11 | 25/6 ATÜ POLİETİLEN BORU (SİYAH) | 100 mt. | 1,347 |
| 001 165 406032 00 11 | 32/6 ATÜ POLİETİLEN BORU (SİYAH) | 100 mt. | 2,111 |
| 001 165 406037 00 11 | 37/6 ATÜ POLİETİLEN BORU (SİYAH) | 100 mt. | 2,482 |
| 001 165 406040 00 11 | 40/6 ATÜ POLİETİLEN BORU (SİYAH) | 100 mt. | 2,733 |
| 001 165 406050 00 11 | 50/6 ATÜ POLİETİLEN BORU (SİYAH) | 100 mt. | 4,083 |
| 001 165 406063 00 11 | 63/6 ATÜ POLİETİLEN BORU (SİYAH) | 100 mt. | 6,319 |
| 001 165 406075 00 11 | 75/6 ATÜ POLİETİLEN BORU (SİYAH) | 100 mt. | 8,317 |
| 001 165 406090 00 11 | 90/6 ATÜ POLİETİLEN BORU (SİYAH) | 100 mt. | 11,622 |

POLİETİLEN SİYAH YER ALTI BORULAR (750N)

| | | | |
|----------------------|------------------------------------|---------|--------|
| 001 165 410014 00 11 | 14/10 ATÜ POLİETİLEN BORU (SİYAH) | 100 mt. | 0,718 |
| 001 165 410016 00 11 | 16/10 ATÜ POLİETİLEN BORU (SİYAH) | 100 mt. | 0,842 |
| 001 165 410018 00 11 | 18/10 ATÜ POLİETİLEN BORU (SİYAH) | 100 mt. | 0,972 |
| 001 165 410020 00 11 | 20/10 ATÜ POLİETİLEN BORU (SİYAH) | 100 mt. | 1,185 |
| 001 165 410025 00 11 | 25/10 ATÜ POLİETİLEN BORU (SİYAH) | 100 mt. | 1,556 |
| 001 165 410032 00 11 | 32/10 ATÜ POLİETİLEN BORU (SİYAH) | 100 mt. | 2,245 |
| 001 165 410037 00 11 | 37/10 ATÜ POLİETİLEN BORU (SİYAH) | 100 mt. | 2,905 |
| 001 165 410040 00 11 | 40/10 ATÜ POLİETİLEN BORU (SİYAH) | 100 mt. | 3,418 |
| 001 165 410050 00 11 | 50/10 ATÜ POLİETİLEN BORU (SİYAH) | 100 mt. | 4,937 |
| 001 165 410063 00 11 | 63/10 ATÜ POLİETİLEN BORU (SİYAH) | 100 mt. | 7,150 |
| 001 165 410075 00 11 | 75/10 ATÜ POLİETİLEN BORU (SİYAH) | 100 mt. | 8,858 |
| 001 165 410090 00 11 | 90/10 ATÜ POLİETİLEN BORU (SİYAH) | 100 mt. | 14,112 |
| 001 165 410100 00 11 | 100/10 ATÜ POLİETİLEN BORU (SİYAH) | 50 mt. | 17,465 |
| 001 165 410110 00 11 | 110/10 ATÜ POLİETİLEN BORU (SİYAH) | 50 mt. | 19,961 |

HDPE KORUGE BORULAR

| | | | |
|----------------|-------------------------------|---------|-------|
| 096 045 150050 | 50 Ø KORUGE KANGAL BORU | 100 mt. | 4,167 |
| 096 045 150060 | 63 Ø KORUGE KANGAL BORU | 100 mt. | 4,554 |
| 096 045 150075 | 75 Ø KORUGE KANGAL BORU | 100 mt. | 5,417 |
| 096 045 150100 | 100 Ø KORUGE BOY BORU (6 MT.) | 6 mt. | 6,221 |
| 096 045 150115 | 115 Ø KORUGE BOY BORU (6 MT.) | 6 mt. | 6,548 |
| 096 045 150002 | 100 Ø MANŞON | 1 ad. | 2,866 |
| 096 045 150001 | 115 Ø MANŞON | 1 ad. | 3,163 |

HDPE KORUGE BORULAR

| | | | |
|----------------|---------------------------------|-------|-------|
| 096 045 160050 | 50 Ø KORUGE KANGAL BORU+MANŞON | 6 mt. | 4,344 |
| 096 045 160075 | 75 Ø KORUGE KANGAL BORU+MANŞON | 6 mt. | 5,317 |
| 096 045 150110 | 110 Ø KORUGE KANGAL BORU+MANŞON | 6 mt. | 7,251 |

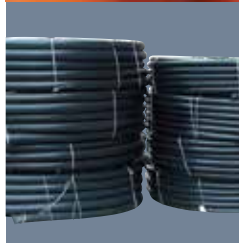

| Kod | Açıklama / Stok Cinsi | Amb. Kutu/Bağ | Amb. Koli/Çvl | FİYAT |
|-----|-----------------------|---------------|---------------|-------|
|-----|-----------------------|---------------|---------------|-------|

MEKS SERİSİ HALOGEN FREE TURUNCU BORULAR (6 ATÜ) (ALEV YAYAN)(320N)

| | | | |
|----------------------|---------------------------------|---------|--------|
| 001 165 506014 00 12 | 14/6 ATÜ BORU (H.FREE)(A.YAYAN) | 100 mt. | 0,720 |
| 001 165 506016 00 12 | 16/6 ATÜ BORU (H.FREE)(A.YAYAN) | 100 mt. | 0,872 |
| 001 165 506018 00 12 | 18/6 ATÜ BORU (H.FREE)(A.YAYAN) | 100 mt. | 1,050 |
| 001 165 506020 00 12 | 20/6 ATÜ BORU (H.FREE)(A.YAYAN) | 100 mt. | 1,179 |
| 001 165 506025 00 12 | 25/6 ATÜ BORU (H.FREE)(A.YAYAN) | 100 mt. | 1,556 |
| 001 165 506032 00 12 | 32/6 ATÜ BORU (H.FREE)(A.YAYAN) | 100 mt. | 2,429 |
| 001 165 506037 00 12 | 37/6 ATÜ BORU (H.FREE)(A.YAYAN) | 100 mt. | 3,102 |
| 001 165 506040 00 12 | 40/6 ATÜ BORU (H.FREE)(A.YAYAN) | 100 mt. | 3,597 |
| 001 165 506050 00 12 | 50/6 ATÜ BORU (H.FREE)(A.YAYAN) | 100 mt. | 5,038 |
| 001 165 506063 00 12 | 63/6 ATÜ BORU (H.FREE)(A.YAYAN) | 100 mt. | 7,867 |
| 001 165 506075 00 12 | 75/6 ATÜ BORU (H.FREE)(A.YAYAN) | 100 mt. | 9,928 |
| 001 165 506090 00 12 | 90/6 ATÜ BORU (H.FREE)(A.YAYAN) | 75 mt. | 14,998 |

MEKS SERİSİ H.FREE BORULAR (10 ATÜ) (A.YAYAN)(750N)

| | | | |
|----------------------|-----------------------------------|---------|--------|
| 001 165 510014 00 12 | 14/10 ATÜ BORU (H.FREE)(A.YAYAN) | 100 mt. | 0,813 |
| 001 165 510016 00 12 | 16/10 ATÜ BORU (H.FREE)(A.YAYAN) | 100 mt. | 0,968 |
| 001 165 510018 00 12 | 18/10 ATÜ BORU (H.FREE)(A.YAYAN) | 100 mt. | 1,198 |
| 001 165 510020 00 12 | 20/10 ATÜ BORU (H.FREE)(A.YAYAN) | 100 mt. | 1,457 |
| 001 165 510025 00 12 | 25/10 ATÜ BORU (H.FREE)(A.YAYAN) | 100 mt. | 1,815 |
| 001 165 510032 00 12 | 32/10 ATÜ BORU (H.FREE)(A.YAYAN) | 100 mt. | 2,878 |
| 001 165 510037 00 12 | 37/10 ATÜ BORU (H.FREE)(A.YAYAN) | 100 mt. | 3,641 |
| 001 165 510040 00 12 | 40/10 ATÜ BORU (H.FREE)(A.YAYAN) | 100 mt. | 4,732 |
| 001 165 510050 00 12 | 50/10 ATÜ BORU (H.FREE)(A.YAYAN) | 100 mt. | 6,173 |
| 001 165 510063 00 12 | 63/10 ATÜ BORU (H.FREE)(A.YAYAN) | 100 mt. | 8,942 |
| 001 165 510075 00 12 | 75/10 ATÜ BORU (H.FREE)(A.YAYAN) | 100 mt. | 10,561 |
| 001 165 510090 00 12 | 90/10 ATÜ BORU (H.FREE)(A.YAYAN) | 75 mt. | 17,424 |
| 001 165 510100 00 12 | 100/10 ATÜ BORU (H.FREE)(A.YAYAN) | 50 mt. | 21,609 |
| 001 165 510110 00 12 | 110/10 ATÜ BORU (H.FREE)(A.YAYAN) | 50 mt. | 24,033 |

MEKS SERİSİ H.FREE BORULAR (6 ATÜ) (A.YAYMAYAN)(320N)

| | | | |
|----------------------|------------------------------------|---------|--------|
| 001 165 106014 00 12 | 14/6 ATÜ BORU (H.FREE)(A.YAYMAYAN) | 100 mt. | 1,198 |
| 001 165 106016 00 12 | 16/6 ATÜ BORU (H.FREE)(A.YAYMAYAN) | 100 mt. | 1,397 |
| 001 165 106018 00 12 | 18/6 ATÜ BORU (H.FREE)(A.YAYMAYAN) | 100 mt. | 1,602 |
| 001 165 106020 00 12 | 20/6 ATÜ BORU (H.FREE)(A.YAYMAYAN) | 100 mt. | 1,951 |
| 001 165 106025 00 12 | 25/6 ATÜ BORU (H.FREE)(A.YAYMAYAN) | 100 mt. | 2,465 |
| 001 165 106032 00 12 | 32/6 ATÜ BORU (H.FREE)(A.YAYMAYAN) | 100 mt. | 4,108 |
| 001 165 106037 00 12 | 37/6 ATÜ BORU (H.FREE)(A.YAYMAYAN) | 100 mt. | 5,134 |
| 001 165 106040 00 12 | 40/6 ATÜ BORU (H.FREE)(A.YAYMAYAN) | 100 mt. | 5,751 |
| 001 165 106050 00 12 | 50/6 ATÜ BORU (H.FREE)(A.YAYMAYAN) | 100 mt. | 8,831 |
| 001 165 106063 00 12 | 63/6 ATÜ BORU (H.FREE)(A.YAYMAYAN) | 100 mt. | 12,998 |
| 001 165 106075 00 12 | 75/6 ATÜ BORU (H.FREE)(A.YAYMAYAN) | 100 mt. | 17,457 |
| 001 165 106090 00 12 | 90/6 ATÜ BORU (H.FREE)(A.YAYMAYAN) | 75 mt. | 24,645 |

MEKS SERİSİ H.FREE BORULAR (10 ATÜ) (A.YAYMAYAN)(750N)

| | | | |
|----------------------|--------------------------------------|---------|--------|
| 001 165 110014 00 12 | 14/10 ATÜ BORU (H.FREE)(A.YAYMAYAN) | 100 mt. | 1,335 |
| 001 165 110016 00 12 | 16/10 ATÜ BORU (H.FREE)(A.YAYMAYAN) | 100 mt. | 1,602 |
| 001 165 110018 00 12 | 18/10 ATÜ BORU (H.FREE)(A.YAYMAYAN) | 100 mt. | 1,951 |
| 001 165 110020 00 12 | 20/10 ATÜ BORU (H.FREE)(A.YAYMAYAN) | 100 mt. | 2,465 |
| 001 165 110025 00 12 | 25/10 ATÜ BORU (H.FREE)(A.YAYMAYAN) | 100 mt. | 2,875 |
| 001 165 110032 00 12 | 32/10 ATÜ BORU (H.FREE)(A.YAYMAYAN) | 100 mt. | 4,518 |
| 001 165 110037 00 12 | 37/10 ATÜ BORU (H.FREE)(A.YAYMAYAN) | 100 mt. | 6,161 |
| 001 165 110040 00 12 | 40/10 ATÜ BORU (H.FREE)(A.YAYMAYAN) | 100 mt. | 7,394 |
| 001 165 110050 00 12 | 50/10 ATÜ BORU (H.FREE)(A.YAYMAYAN) | 100 mt. | 10,680 |
| 001 165 110063 00 12 | 63/10 ATÜ BORU (H.FREE)(A.YAYMAYAN) | 100 mt. | 15,541 |
| 001 165 110075 00 12 | 75/10 ATÜ BORU (H.FREE)(A.YAYMAYAN) | 100 mt. | 19,781 |
| 001 165 110090 00 12 | 90/10 ATÜ BORU (H.FREE)(A.YAYMAYAN) | 75 mt. | 29,780 |
| 001 165 110100 00 12 | 100/10 ATÜ BORU (H.FREE)(A.YAYMAYAN) | 50 mt. | 37,304 |
| 001 165 110110 00 12 | 110/10 ATÜ BORU (H.FREE)(A.YAYMAYAN) | 50 mt. | 41,075 |

PLASTİK BORULAR

| | | | |
|----------------------|-------------------------------|-----------------|-------|
| 001 045 000014 30 00 | 14 MM KALIN BOY BORU | 102 mt 510 mt. | 0,550 |
| 001 045 000018 30 00 | 18 MM KALIN BOY BORU | 102 mt 510 mt. | 0,739 |
| 001 045 000026 30 00 | 26 MM KALIN BOY BORU | 51 mt. 255 mt. | 1,344 |
| 001 045 000037 30 00 | 37 MM KALIN BOY BORU | 30 mt. | 2,568 |
| 001 045 010014 00 11 | 14 MM KANGAL (NORMAL) | 100 mt. | 0,547 |
| 001 045 010018 00 11 | 18 MM KANGAL (NORMAL) | 100 mt. | 0,739 |
| 001 045 010026 00 11 | 26 MM KANGAL (NORMAL) | 50 mt. | 1,339 |
| 001 045 010037 00 11 | 37 MM KANGAL (NORMAL) | 50 mt. | 2,935 |
| 001 045 020014 00 00 | 14 MM KANGAL (KAUÇUK) | 100 mt. | 0,540 |
| 001 045 020018 00 00 | 18 MM KANGAL (KAUÇUK) | 100 mt. | 0,749 |
| 001 045 020026 00 00 | 26 MM KANGAL (KAUÇUK) | 50 mt. | 1,339 |
| 001 045 020037 00 00 | 37 MM KANGAL (KAUÇUK) | 50 mt. | 2,826 |
| 001 045 030014 00 00 | 14 MM KANGAL (KAUÇUK) (KALIN) | 100 mt. | 0,669 |
| 001 045 030018 00 00 | 18 MM KANGAL (KAUÇUK) (KALIN) | 100 mt. | 0,928 |

PLASTİK DİRSEK VE MUFLAR

| | | | |
|----------------------|---------------------|--------------|-------|
| 127 051 000014 | PLASTİK 14 Ø DİRSEK | 100 ad 2000 | 0,190 |
| 127 051 000018 | PLASTİK 18 Ø DİRSEK | 100 ad 1000 | 0,225 |
| 127 051 000026 | PLASTİK 26 Ø DİRSEK | 100 ad 500 | 0,306 |
| 001 051 020014 00 11 | PLASTİK 14 Ø MUF | 1500 | 0,190 |
| 001 051 020018 00 11 | PLASTİK 18 Ø MUF | 1000 | 0,257 |
| 001 051 020026 00 11 | PLASTİK 26 Ø MUF | 500 | 0,280 |

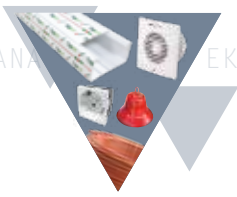

| Kod | Açıklama / Stok Cinsi | Amb. Kutu/Bağ | Amb. Koli/Çyl | FİYAT |
|--------------------------------------|--|---------------|---------------|-------|
| PVC.ALEV YAYMAYAN BOY BORULAR | | | | |
| 001 045 120014 30 17 | 14 Ø PVC. ALEV YAYMAYAN BOY BORU (BOY: 3 MT) | 102 mt. | | 1,236 |
| 001 045 120016 30 17 | 16 Ø PVC. ALEV YAYMAYAN BOY BORU (BOY: 3 MT) | 102 mt. | | 1,268 |
| 001 045 120018 30 17 | 18 Ø PVC. ALEV YAYMAYAN BOY BORU (BOY: 3 MT) | 102 mt. | | 1,693 |
| 001 045 120020 30 17 | 20 Ø PVC. ALEV YAYMAYAN BOY BORU (BOY: 3 MT) | 102 mt. | | 2,017 |
| 001 045 120025 30 17 | 25 Ø PVC. ALEV YAYMAYAN BOY BORU (BOY: 3 MT) | 51 mt. | | 2,742 |
| 001 045 120032 30 17 | 32 Ø PVC. ALEV YAYMAYAN BOY BORU (BOY: 3 MT) | 30 mt. | | 4,202 |
| 001 045 120040 30 17 | 40 Ø PVC. ALEV YAYMAYAN BOY BORU (BOY: 3 MT) | 30 mt. | | 7,615 |

| Kod | Açıklama / Stok Cinsi | Amb. Kutu/Bağ | Amb. Koli/Çyl | FİYAT |
|--|--|---------------|---------------|-------|
| PVC.ALEV YAYMAYAN KENDİNDEN MUFLU BOY BORULAR | | | | |
| 001 045 110014 30 17 | 14 Ø PVC. ALEV YAYMAYAN KENDİNDEN MUFLU BOY BORU(3M) | 102 mt. | | 1,475 |
| 001 045 110016 30 17 | 16 Ø PVC. ALEV YAYMAYAN KENDİNDEN MUFLU BOY BORU(3M) | 102 mt. | | 1,542 |
| 001 045 110018 30 17 | 18 Ø PVC. ALEV YAYMAYAN KENDİNDEN MUFLU BOY BORU(3M) | 102 mt. | | 1,807 |
| 001 045 110020 30 17 | 20 Ø PVC. ALEV YAYMAYAN KENDİNDEN MUFLU BOY BORU(3M) | 102 mt. | | 2,131 |
| 001 045 110025 30 17 | 25 Ø PVC. ALEV YAYMAYAN KENDİNDEN MUFLU BOY BORU(3M) | 51 mt. | | 3,010 |
| 001 045 110032 30 17 | 32 Ø PVC. ALEV YAYMAYAN KENDİNDEN MUFLU BOY BORU(3M) | 30 mt. | | 4,382 |
| 001 045 110040 30 17 | 40 Ø PVC. ALEV YAYMAYAN KENDİNDEN MUFLU BOY BORU(3M) | 30 mt. | | 7,769 |

| Kod | Açıklama / Stok Cinsi | Amb. Kutu/Bağ | Amb. Koli/Çyl | FİYAT |
|---------------------------------------|---------------------------|---------------|---------------|-------|
| DİRSEK VE MUFLAR ALEV YAYMAYAN | | | | |
| 001 051 010014 00 17 | 14 Ø DİRSEK ALEV YAYMAYAN | 100 ad. | 700 | 0,545 |
| 001 051 010016 00 17 | 16 Ø DİRSEK ALEV YAYMAYAN | 100 ad. | 600 | 0,457 |
| 001 051 010018 00 17 | 18 Ø DİRSEK ALEV YAYMAYAN | 100 ad. | 400 | 0,573 |
| 001 051 010020 00 17 | 20 Ø DİRSEK ALEV YAYMAYAN | 100 ad. | 300 | 0,786 |
| 001 051 010025 00 17 | 25 Ø DİRSEK ALEV YAYMAYAN | 50 ad. | 150 | 0,878 |
| 001 051 010032 00 17 | 32 Ø DİRSEK ALEV YAYMAYAN | 50 ad. | 100 | 2,018 |
| 001 051 030014 00 17 | 14-16 Ø MUF ALEV YAYMAYAN | 100 ad. | 700 | 0,304 |
| 001 051 030018 00 17 | 18-20 Ø MUF ALEV YAYMAYAN | 100 ad. | 700 | 0,735 |
| 001 051 030025 00 17 | 25 Ø MUF ALEV YAYMAYAN | 50 ad. | 300 | 0,795 |
| 001 051 030032 00 17 | 32 Ø MUF ALEV YAYMAYAN | 50 ad. | 200 | 0,878 |

| Kod | Açıklama / Stok Cinsi | Amb. Kutu/Bağ | Amb. Koli/Çyl | FİYAT |
|--|---|---------------|---------------|-------|
| GEÇMELİ TİP ANTİGRON BORU KROŞELERİ | | | | |
| 001 048 010016 00 17 | 16 Ø ANTİGRON BORU KROŞESİ (GEÇMELİ) | 100 ad. | 2000 | 0,184 |
| 001 048 010018 00 17 | 18 Ø ANTİGRON BORU KROŞESİ (GEÇMELİ) | 100 ad. | 4000 | 0,187 |
| 001 048 010020 00 17 | 20 Ø ANTİGRON BORU KROŞESİ (GEÇMELİ) | 100 ad. | 1500 | 0,190 |
| 001 048 010025 00 17 | 25 Ø ANTİGRON BORU KROŞESİ (GEÇMELİ) | 100 ad. | 1000 | 0,203 |
| 001 048 010032 00 17 | 32 Ø ANTİGRON BORU KROŞESİ (GEÇMELİ) | 100 ad. | 800 | 0,212 |
| 001 048 010040 00 17 | 40 Ø ANTİGRON BORU KROŞESİ (GEÇMELİ) | 100 ad. | 1000 | 0,429 |
| 074 048 050016 | 16 Ø ANTİGRON BORU KROŞESİ KAPAKLI(GEÇMELİ) | 100 ad. | 4000 | 0,306 |
| 074 048 050017 | 20 Ø ANTİGRON BORU KROŞESİ KAPAKLI(GEÇMELİ) | 100 ad. | 3000 | 0,306 |
| 074 048 050025 | 25 Ø ANTİGRON BORU KROŞESİ KAPAKLI(GEÇMELİ) | 100 ad. | 2500 | 0,345 |
| 074 048 050032 | 32 Ø ANTİGRON BORU KROŞESİ KAPAKLI(GEÇMELİ) | 100 ad. | 1500 | 0,470 |

| Kod | Açıklama / Stok Cinsi | Amb. Kutu/Bağ | Amb. Koli/Çyl | FİYAT |
|---|---|---------------|---------------|-------|
| ŞEFFAF H.F.A.YAYAN BORU-SPRAL EK MUF | | | | |
| 999 999 777616 | 16 LİK ŞEFFAF H.F.ALEV YAYAN BORU-SPRAL EK MUFU | 100 ad. | | 1,161 |
| 999 999 777620 | 20 LİK ŞEFFAF H.F.ALEV YAYAN BORU-SPRAL EK MUFU | 100 ad. | | 1,295 |
| 999 999 777625 | 25 LİK ŞEFFAF H.F.ALEV YAYAN BORU-SPRAL EK MUFU | 100 ad. | | 1,354 |
| 999 999 777632 | 32 LİK ŞEFFAF H.F.ALEV YAYAN BORU-SPRAL EK MUFU | 100 ad. | | 1,682 |



| Kod | Açıklama / Stok Cinsi | Amb. Kutu/Bağ | Amb. Koli/Çyl | FİYAT |
|--|---|---------------|---------------|--------|
| HALOJEN FREE ALEV YAYMAYAN BOY BORULAR (320N) | | | | |
| 001 045 500016 30 17 | 16 Ø PVC. A.YAYMAYAN BORU(3M) HALOJEN FREE (320N) | 102 mt. | | 3,479 |
| 001 045 500020 30 17 | 20 Ø PVC. A.YAYMAYAN BORU(3M) HALOJEN FREE (320N) | 102 mt. | | 4,474 |
| 001 045 500025 30 17 | 25 Ø PVC. A.YAYMAYAN BORU(3M) HALOJEN FREE (320N) | 102 mt. | | 6,462 |
| 001 045 500032 30 17 | 32 Ø PVC. A.YAYMAYAN BORU(3M) HALOJEN FREE (320N) | 102 mt. | | 9,444 |
| 001 045 500040 30 17 | 40 Ø PVC. A.YAYMAYAN BORU(3M) HALOJEN FREE (320N) | 51 mt. | | 13,421 |
| 001 045 500050 30 17 | 50 Ø PVC. A.YAYMAYAN BORU(3M) HALOJEN FREE (320N) | 30 mt. | | 28,570 |

| Kod | Açıklama / Stok Cinsi | Amb. Kutu/Bağ | Amb. Koli/Çyl | FİYAT |
|--|---|---------------|---------------|--------|
| HALOJEN FREE ALEV YAYMAYAN BOY BORULAR (750N) | | | | |
| 001 045 510016 30 17 | 16 Ø PVC. A.YAYMAYAN BORU(3M) HALOJEN FREE (750N) | 102 mt. | | 3,728 |
| 001 045 510020 30 17 | 20 Ø PVC. A.YAYMAYAN BORU(3M) HALOJEN FREE (750N) | 102 mt. | | 4,971 |
| 001 045 510025 30 17 | 25 Ø PVC. A.YAYMAYAN BORU(3M) HALOJEN FREE (750N) | 102 mt. | | 6,959 |
| 001 045 510032 30 17 | 32 Ø PVC. A.YAYMAYAN BORU(3M) HALOJEN FREE (750N) | 102 mt. | | 9,941 |
| 001 045 510040 30 17 | 40 Ø PVC. A.YAYMAYAN BORU(3M) HALOJEN FREE (750N) | 51 mt. | | 13,918 |
| 001 045 510050 30 17 | 50 Ø PVC. A.YAYMAYAN BORU(3M) HALOJEN FREE (750N) | 30 mt. | | 29,080 |

| Kod | Açıklama / Stok Cinsi | Amb. Kutu/Bağ | Amb. Koli/Çyl | FİYAT |
|---|--|---------------|---------------|--------|
| HALOJEN FREE ALEV YAYMAYAN BOY BORULAR (1250N) | | | | |
| 001 045 520016 30 17 | 16 Ø PVC. A.YAYMAYAN BORU(3M) HALOJEN FREE (1250N) | 102 mt. | | 3,976 |
| 001 045 520020 30 17 | 20 Ø PVC. A.YAYMAYAN BORU(3M) HALOJEN FREE (1250N) | 102 mt. | | 5,219 |
| 001 045 520025 30 17 | 25 Ø PVC. A.YAYMAYAN BORU(3M) HALOJEN FREE (1250N) | 102 mt. | | 7,456 |
| 001 045 520032 30 17 | 32 Ø PVC. A.YAYMAYAN BORU(3M) HALOJEN FREE (1250N) | 102 mt. | | 11,184 |
| 001 045 520040 30 17 | 40 Ø PVC. A.YAYMAYAN BORU(3M) HALOJEN FREE (1250N) | 51 mt. | | 14,415 |
| 001 045 520050 30 17 | 50 Ø PVC. A.YAYMAYAN BORU(3M) HALOJEN FREE (1250N) | 30 mt. | | 29,575 |

| Kod | Açıklama / Stok Cinsi | Amb. Kutu/Bağ | Amb. Koli/Çyl | FİYAT |
|---|---|---------------|---------------|-------|
| DÜZ BORU T DİRSEK H.FREE ALEV YAYMAYAN | | | | |
| 999 999 999888 | 16 Ø DÜZ BORU T DİRSEK H.FREE ALEV YAYMAYAN | 100 ad. | 300 | 1,741 |
| 999 999 999889 | 20 Ø DÜZ BORU T DİRSEK H.FREE ALEV YAYMAYAN | 100 ad. | 300 | 2,009 |
| 999 999 999890 | 25 Ø DÜZ BORU T DİRSEK H.FREE ALEV YAYMAYAN | 100 ad. | 300 | 2,158 |
| 999 999 999891 | 32 Ø DÜZ BORU T DİRSEK H.FREE ALEV YAYMAYAN | 100 ad. | 200 | 2,679 |

| Kod | Açıklama / Stok Cinsi | Amb. Kutu/Bağ | Amb. Koli/Çyl | FİYAT |
|---|---|---------------|---------------|-------|
| DÜZ BORU REKORU H.FREE ALEV YAYMAYAN | | | | |
| 999 999 998816 | 16 Ø DÜZ BORU REKORU H.FREE ALEV YAYMAYAN | 100 ad. | | 1,920 |
| 999 999 998820 | 20 Ø DÜZ BORU REKORU H.FREE ALEV YAYMAYAN | 100 ad. | | 2,247 |
| 999 999 998825 | 25 Ø DÜZ BORU REKORU H.FREE ALEV YAYMAYAN | 100 ad. | | 2,560 |
| 999 999 998832 | 32 Ø DÜZ BORU REKORU H.FREE ALEV YAYMAYAN | 100 ad. | | 3,200 |

| Kod | Açıklama / Stok Cinsi | Amb. Kutu/Bağ | Amb. Koli/Çyl | FİYAT |
|--|---|---------------|---------------|-------|
| ANTİGRON BORU KROŞESİ (GEÇMELİ) H.FREE A.YAYMAYAN | | | | |
| 074 048 060016 | 16 Ø ANT. BORU KROŞESİ(GEÇMELİ) KAPAKLI H.FREE A.YAYMAYAN | 100 ad. | | 0,387 |
| 074 048 060020 | 20 Ø ANT. BORU KROŞESİ(GEÇMELİ) KAPAKLI H.FREE A.YAYMAYAN | 100 ad. | | 0,446 |
| 074 048 060025 | 25 Ø ANT. BORU KROŞESİ(GEÇMELİ) KAPAKLI H.FREE A.YAYMAYAN | 100 ad. | | 0,506 |
| 074 048 060032 | 32 Ø ANT. BORU KROŞESİ(GEÇMELİ) KAPAKLI H.FREE A.YAYMAYAN | 50 ad. | | 0,580 |

| Kod | Açıklama / Stok Cinsi | Amb. Kutu/Bağ | Amb. Koli/Çyl | FİYAT |
|--|---|---------------|---------------|-------|
| SİRAL REKORU H.FREE ALEV YAYMAYAN | | | | |
| 999 999 777516 | 16 Ø SİRAL REKORU KAPAKLI H.FREE A.YAYMAYAN | 100 ad. | | 1,607 |
| 999 999 777520 | 20 Ø SİRAL REKORU KAPAKLI H.FREE A.YAYMAYAN | 100 ad. | | 2,247 |
| 999 999 777525 | 25 Ø SİRAL REKORU KAPAKLI H.FREE A.YAYMAYAN | 100 ad. | | 2,887 |
| 999 999 777532 | 32 Ø SİRAL REKORU KAPAKLI H.FREE A.YAYMAYAN | 50 ad. | | 3,840 |

| Kod | Açıklama / Stok Cinsi | Amb. Kutu/Bağ | Amb. Kolu/Cvl | FİYAT |
|-----------------------------------|-------------------------------|---------------|---------------|-------|
| PLASTİK KASA-BUAT-TAKOZLAR | | | | |
| 126 046 130103 | NORM KASA | 100 ad. | 1000 | 0,212 |
| 126 046 130104 | NORM BUAT (14-18 ÇIKIŞLI) | 50 ad. | 500 | 0,423 |
| 126 046 130105 | NORM BUAT KAPAKSIZ | 50 ad. | 500 | 0,357 |
| 001 046 160102 00 11 | GEÇMELİ PLASTİK KASA | 100 ad. | 400 | 0,588 |
| 126 046 130106 | GEÇMELİ DERİN KASA | 100 ad. | 500 | 0,423 |
| 126 046 130107 | GEÇMELİ DERİN KASA KAPAKSIZ | 100 ad. | 500 | 0,357 |
| 001 046 120101 00 11 | ALÇIPAN KASA 1'Lİ | 75 ad. | 300 | 1,023 |
| 001 046 120102 00 11 | ALÇIPAN KASA 2'Lİ | 50 ad. | 200 | 1,358 |
| 001 046 120103 00 11 | ALÇIPAN KASA 3'Lİ | 25 ad. | 100 | 1,795 |
| 001 046 120100 00 11 | GEÇMELİ ALÇ.KASA SİYAH | 50 ad. | 300 | 0,930 |
| 001 046 170101 00 11 | TUNEL KASA | 100 ad. | 500 | 1,016 |
| 001 046 170102 00 11 | TUNEL BUAT | 50 ad. | 300 | 0,528 |
| 001 046 000001 00 11 | PLASTİK TAKOZ (14-18 ÇIKIŞLI) | 100 ad. | 1000 | 0,283 |

TURUNCU KASA VE BUATLAR (ALEV YAYAN)

| | | | | |
|----------------------|--|---------|------|-------|
| 001 046 130102 00 12 | NORM KASA (TURUNCU)(ALEV YAYAN) | 100 ad. | 1000 | 0,311 |
| 001 046 130101 00 12 | NORM BUAT (TURUNCU)(ALEV YAYAN) | 50 ad. | 500 | 0,591 |
| 001 046 160102 00 12 | GEÇMELİ PLASTİK KASA (TURUNCU)(ALEV YAYAN) | 100 ad. | 400 | 0,457 |
| 001 046 160101 00 12 | GEÇMELİ DERİN KASA (TURUNCU)(ALEV YAYAN) | 100 ad. | 500 | 0,591 |
| 001 046 170101 00 12 | TUNEL KASA (TURUNCU)(ALEV YAYAN) | 100 ad. | 500 | 1,936 |
| 001 046 170102 00 12 | TUNEL BUAT (TURUNCU)(ALEV YAYAN) | 50 ad. | 300 | 1,023 |
| 001 046 120101 00 12 | ALÇIPAN KASA 1'Lİ (TURUNCU)(ALEV YAYAN) | 75 ad. | 300 | 1,137 |
| 001 046 120102 00 12 | ALÇIPAN KASA 2'Lİ (TURUNCU)(ALEV YAYAN) | 50 ad. | 200 | 1,415 |
| 001 046 120103 00 12 | ALÇIPAN KASA 3'LÜ (TURUNCU)(ALEV YAYAN) | 25 ad. | 100 | 1,857 |
| 001 046 120104 00 12 | ALÇIPAN KASA 4'LÜ (TURUNCU)(ALEV YAYAN) | 28 ad. | | 4,032 |
| 001 046 120105 00 12 | ALÇIPAN KASA 5'Lİ (TURUNCU)(ALEV YAYAN) | 24 ad. | | 4,885 |
| 001 046 120106 00 12 | ALÇIPAN KASA 6'Lİ (TURUNCU)(ALEV YAYAN) | 20 ad. | | 5,831 |
| 001 046 120100 00 12 | GEÇMELİ ALÇIPAN KASA (TURUNCU)(ALEV YAYAN) | 50 ad. | 300 | 1,165 |

TURUNCU KASA VE BUATLAR (ALEV YAYMAYAN)

| | | | | |
|----------------------|---|---------|------|-------|
| 001 046 131102 00 12 | NORM KASA (TURUNCU)(ALEV YAYMAYAN) | 100 ad. | 1000 | 0,389 |
| 001 046 131101 00 12 | NORM BUAT (TURUNCU)(ALEV YAYMAYAN) | 50 ad. | 500 | 0,716 |
| 001 046 161102 00 12 | GEÇMELİ PLASTİK KASA (TURUNCU)(ALEV YAYMAYAN) | 100 ad. | 400 | 0,630 |
| 001 046 161101 00 12 | GEÇMELİ DERİN KASA (TURUNCU)(ALEV YAYMAYAN) | 100 ad. | 500 | 0,716 |
| 001 046 210002 00 12 | TUNEL KASA (TURUNCU)(ALEV YAYMAYAN) | 100 ad. | 500 | 2,071 |
| 001 046 210003 00 12 | TUNEL BUAT (TURUNCU)(ALEV YAYMAYAN) | 50 ad. | 300 | 1,176 |
| 001 046 121101 00 12 | ALÇIPAN KASA 1'Lİ (TURUNCU)(ALEV YAYMAYAN) | 75 ad. | 300 | 1,285 |
| 001 046 121102 00 12 | ALÇIPAN KASA 2'Lİ (TURUNCU)(ALEV YAYMAYAN) | 50 ad. | 200 | 1,575 |
| 001 046 121103 00 12 | ALÇIPAN KASA 3'LÜ (TURUNCU)(ALEV YAYMAYAN) | 25 ad. | 100 | 2,034 |
| 001 046 121100 00 12 | GEÇMELİ ALÇIPAN KASA (TURUNCU)(ALEV YAYMAYAN) | 50 ad. | 300 | 1,302 |

BETON DUVAR ANAHTAR KASALARI (ALEV YAYAN)

| | | | | |
|----------------------|--|---------|------|-------|
| 000 700 000037 00 14 | BUAT ARKA KAPAK SARI (ALEV YAYAN) | 50 ad. | 500 | 0,385 |
| 000 700 000035 00 12 | BUAT GÖVDE 60'LİK TURUNCU (ALEV YAYAN) | 50 ad. | 350 | 0,525 |
| 000 700 000256 00 14 | KALIBA TESPİT ELEMANI SARI (ALEV YAYAN) | | 250 | 0,536 |
| 000 700 000039 00 12 | SİĞ BRÜT ANAH. KASASI TURUNCU (ALEV YAYAN) | 100 ad. | 500 | 0,572 |
| 000 700 000036 00 14 | KONİK GÖVDE SARI (ALEV YAYAN) | 50 ad. | 250 | 0,570 |
| 000 700 000214 00 14 | APLİK 20'LİK SARI (ALEV YAYAN) | 100 ad. | 1000 | 0,344 |
| 000 700 000215 00 12 | APLİK EĞİK BAĞLANTI DİRSEĞİ TURUNCU (ALEV YAYAN) | 100 ad. | 1000 | 0,286 |

BETON DUVAR ANAHTAR KASALARI (ALEV YAYMAYAN)

| | | | | |
|----------------------|---|---------|------|-------|
| 000 700 200037 00 14 | BUAT ARKA KAPAK SARI (ALEV YAYMAYAN) | 50 ad. | 500 | 0,576 |
| 000 700 200035 00 12 | BUAT GÖVDE 60'LİK TURUNCU (ALEV YAYMAYAN) | 50 ad. | 350 | 0,788 |
| 000 700 200256 00 14 | KALIBA TESPİT ELEMANI SARI (ALEV YAYMAYAN) | | 250 | 0,709 |
| 000 700 200039 00 12 | SİĞ BRÜT ANAH. KASASI TURUNCU (ALEV YAYMAYAN) | 100 ad. | 500 | 0,861 |
| 000 700 200036 00 14 | KONİK GÖVDE SARI (ALEV YAYMAYAN) | 50 ad. | 250 | 0,656 |
| 000 700 200214 00 14 | APLİK 20'LİK SARI (ALEV YAYMAYAN) | 100 ad. | 1000 | 0,515 |
| 000 700 200215 00 12 | APLİK EĞİK BAĞLANTI DİRSEĞİ TURUNCU (ALEV YAYMAYAN) | 100 ad. | 1000 | 0,431 |

KARE BUAT

| | | | | |
|----------------------|------------------------------------|--------|-----|-------|
| 001 046 021010 00 11 | 10X10 KARE BUAT | 10 ad. | 300 | 1,759 |
| 001 046 021212 00 11 | 12X12 KARE BUAT | 10 ad. | 200 | 1,683 |
| 001 046 021515 00 11 | 15X15 KARE BUAT | 10 ad. | 120 | 4,241 |
| 001 046 022020 00 11 | 20X20 KARE BUAT | 10 ad. | 70 | 6,596 |
| 001 046 000103 00 11 | ANTİGRON BUAT 3'LÜ PLASTİK (SİYAH) | 10 ad. | 240 | 1,149 |
| 001 046 000104 00 11 | ANTİGRON BUAT 4'LÜ PLASTİK (SİYAH) | 10 ad. | 240 | 0,840 |
| 001 046 000103 00 00 | ANTİGRON BUAT 3'LÜ PLASTİK (BEYAZ) | 10 ad. | 240 | 1,209 |
| 001 046 000104 00 00 | ANTİGRON BUAT 4'LÜ PLASTİK (BEYAZ) | 10 ad. | 240 | 1,059 |

TURUNCU KARE BUAT

| | | | | |
|----------------------|----------------------------|--------|-----|-------|
| 001 046 021010 00 12 | 10X10 KARE BUAT TURUNCU | 10 ad. | 300 | 1,847 |
| 001 046 021212 00 12 | 12X12 KARE BUAT TURUNCU | 10 ad. | 200 | 1,768 |
| 001 046 021515 00 12 | 15X15 KARE BUAT TURUNCU | 10 ad. | 120 | 4,453 |
| 001 046 022020 00 12 | 20X20 KARE BUAT TURUNCU | 10 ad. | 70 | 6,925 |
| 001 046 000103 00 12 | ANTİGRON BUAT 3'LÜ TURUNCU | 10 ad. | 240 | 1,209 |
| 001 046 000104 00 12 | ANTİGRON BUAT 4'LÜ TURUNCU | 10 ad. | 240 | 1,059 |

TURUNCU KARE BUAT (A.YAYMAYAN)

| | | | | |
|----------------------|---------------------------------------|--------|-----|-------|
| 001 046 051010 00 12 | KARE BUAT TURUNCU(10X10) (A.YAYMAYAN) | 10 ad. | 300 | 1,913 |
| 001 046 051212 00 12 | KARE BUAT TURUNCU(12X12) (A.YAYMAYAN) | 10 ad. | 200 | 2,472 |
| 001 046 051515 00 12 | KARE BUAT TURUNCU(15X15) (A.YAYMAYAN) | 10 ad. | 120 | 5,223 |
| 001 046 052020 00 12 | KARE BUAT TURUNCU(20X20) (A.YAYMAYAN) | 10 ad. | 70 | 7,836 |

KARE BUAT KAPAKLARI

| | | | | |
|----------------------|------------------------|-------|-----|-------|
| 000 700 000043 00 00 | 10X10 KARE BUAT KAPAĞI | 1 ad. | 300 | 0,494 |
| 000 700 000045 00 00 | 12X12 KARE BUAT KAPAĞI | 1 ad. | 200 | 0,627 |
| 000 700 000047 00 00 | 15X15 KARE BUAT KAPAĞI | 1 ad. | 200 | 0,804 |
| 000 700 000049 00 00 | 20X20 KARE BUAT KAPAĞI | 1 ad. | 100 | 1,644 |

LÜX BUAT KAPAKLARI

| | | | | |
|----------------|--------------------------------------|---------|------|-------|
| 126 046 180001 | LÜX BUAT KAPAĞI(BOMBELİ-PLS. AYAK) | 100 ad. | 1000 | 0,298 |
| 126 046 180002 | LÜX BUAT KAPAĞI(BOMBELİ-SAC AYAK) | 100 ad. | 1000 | 0,560 |
| 126 046 180003 | LÜX BUAT KAPAĞI(DÜZ PLS. AYAK) | 100 ad. | 1000 | 0,311 |
| 126 046 180004 | LÜX BUAT KAPAĞI(BOMB.PLS.AYAK)VIDALI | 100 ad. | 1000 | 0,467 |





| Kod | Açıklama / Stok Cinsi | Amb. Kutu/Bağ | Amb. Koli/Çift | FİYAT |
|--|--|---------------|----------------|----------|
| FİBER SUSTALAR | | | | |
| 999 999 000779 | FİBER KLAVUZ 11MM (100-120-150-200M) | 1 mt. | | 13,194 |
| 999 999 000780 | FİBER KLAVUZ MAKARASI | 1 ad. | | 663,009 |
| PVC.İZOLE KAPLI ÇELİK SUSTA | | | | |
| 049 019 300010 | 10 MT. PVC.İZOLE KAPLI ÇELİK SUSTA | 1 ad. | 30 | 28,738 |
| 049 019 300015 | 15 MT. PVC.İZOLE KAPLI ÇELİK SUSTA | 1 ad. | 24 | 43,106 |
| 049 019 300020 | 20 MT. PVC.İZOLE KAPLI ÇELİK SUSTA | 1 ad. | 20 | 57,475 |
| 049 019 300025 | 25 MT. PVC.İZOLE KAPLI ÇELİK SUSTA | 1 ad. | 18 | 71,844 |
| PLASTİK SUSTALAR (KILAVUZ TELLİ) | | | | |
| 049 019 400010 | 10 MT.KILAVUZ TELLİ PLASTİK SUSTA | 1 ad. | 25 | 11,181 |
| 049 019 400015 | 15 MT.KILAVUZ TELLİ PLASTİK SUSTA | 1 ad. | 20 | 16,073 |
| 049 019 400020 | 20 MT.KILAVUZ TELLİ PLASTİK SUSTA | 1 ad. | 15 | 22,052 |
| 049 019 400025 | 25 MT KILAVUZ TELLİ PLASTİK SUSTA | 1 ad. | 15 | 27,953 |
| ÇELİK SUSTA VE ZİNCİR | | | | |
| 001 019 000010 00 00 | SUSTA (1.KALİTE) (10M) | 40 ad. | 40 | 17,568 |
| 001 019 000015 00 00 | SUSTA (1.KALİTE) (15M) | 30 ad. | 30 | 25,289 |
| 001 019 000020 00 00 | SUSTA (1.KALİTE) (20M) | 20 ad. | 20 | 33,029 |
| 001 019 000025 00 00 | SUSTA (1.KALİTE) (25M) | 15 ad. | 15 | 40,768 |
| 001 019 100010 00 00 | TAKVİYELİ SUSTA(1.KALİTE)(10M) | 40 ad. | 40 | 20,890 |
| 001 019 100015 00 00 | TAKVİYELİ SUSTA(1.KALİTE)(15M) | 30 ad. | 30 | 30,272 |
| 001 019 100020 00 00 | TAKVİYELİ SUSTA(1.KALİTE)(20M) | 20 ad. | 20 | 39,671 |
| 001 019 100025 00 00 | TAKVİYELİ SUSTA(1.KALİTE)(25M) | 15 ad. | 15 | 49,071 |
| 001 018 000001 00 00 | FLORESAN ZİNCİRİ | 100 mt. | 500 | 0,685 |
| İTHAL SUSTA TABANCASI | | | | |
| 888 888 000007 | SUSTA TABANCASI | 1 ad. | | 396,00 € |
| BASINÇ ŞALTERLERİ VE SU SEVİYE FLATÖRLERİ | | | | |
| IP40 | | | | |
| 011 095 000500 | LM5 (1-6 BAR) MONOFAZE BASINÇ ŞALTERİ 1/4 | 1 ad. | | 38,307 |
| 011 095 000600 | LM6 (2-9 BAR) MONOFAZE BASINÇ ŞALTERİ 1/4 | 1 ad. | | 40,509 |
| 011 095 000601 | LM5 (2-9 BAR) MONOFAZE BSN. ŞALTERİ THL. 1/2 | 1 ad. | | 42,206 |
| 011 095 000100 | LM1 (1-5 BAR) BASINÇ ŞALTERİ TAHLİYESİZ 1/2 | 1 ad. | | 38,307 |
| 011 095 000101 | LM1 (1-5 BAR) BASINÇ ŞALTERİ TAHLİYELİ 1/2 | 1 ad. | | 40,509 |
| 011 095 000200 | LM2 (2-8 BAR) BASINÇ ŞALTERİ TAHLİYESİZ 1/2 | 1 ad. | | 46,403 |
| 011 095 000201 | LM2 (2-8 BAR) BASINÇ ŞALTERİ TAHLİYELİ 1/2 | 1 ad. | | 50,629 |
| 011 095 000300 | LM3 (3-11 BAR) BASINÇ ŞALTERİ TAHLİYESİZ 1/2 | 1 ad. | | 46,403 |
| 011 095 000301 | LM3 (3-11 BAR) BASINÇ ŞALTERİ TAHLİYELİ 1/2 | 1 ad. | | 50,629 |
| 011 095 000400 | LM4 (4-16 BAR) BASINÇ ŞALTERİ TAHLİYESİZ 1/2 | 1 ad. | | 46,403 |
| 011 095 000401 | LM4 (4-16 BAR) BASINÇ ŞALTERİ TAHLİYELİ 1/2 | 1 ad. | | 50,629 |
| 011 096 000591 | SU SEVİYE FLATÖRÜ (0,6M TTR KABLÖLÜ) | 1 ad. | | 24,466 |
| 011 096 000592 | SU SEVİYE FLATÖRÜ (1,6M TTR KABLÖLÜ) | 1 ad. | | 31,223 |
| 011 096 000593 | SU SEVİYE FLATÖRÜ (3M TTR KABLÖLÜ) | 1 ad. | | 35,449 |
| 011 096 000590 | SU SEVİYE FLATÖRÜ (5M TTR KABLÖLÜ) | 1 ad. | | 44,736 |
| 011 096 000594 | SU SEVİYE FLATÖRÜ (10M TTR KABLÖLÜ) | 1 ad. | | 75,959 |
| 011 096 000595 | ATIK SU SEVİYE FLATÖRÜ (3 MT KAUÇUK KABLÖLÜ) | 1 ad. | | 87,745 |
| 011 096 000596 | ATIK SU SEVİYE FLATÖRÜ (5 MT KAUÇUK KABLÖLÜ) | 1 ad. | | 97,895 |
| 011 096 000597 | ATIK SU SEVİYE FLATÖRÜ (10 MT KAUÇUK KABLÖLÜ) | 1 ad. | | 135,011 |
| 011 096 000598 | ATIK SU SEVİYE FLATÖRÜ (15 MT KAUÇUK KABLÖLÜ) | 1 ad. | | 163,704 |
| ŞALTERLER | | | | |
| 041 118 000201 | MONOFAZE ŞALTER | 1 ad. | 100 | 14,531 |
| 041 118 000200 | TRİFAZE ŞALTER | 1 ad. | 50 | 25,010 |
| SAYAÇ KUTULARI | | | | |
| 047 089 010855 | MONOFAZE MODÜLER SAYAÇ KUTUSU(215X405X115) MM | 1 ad. | | 59,874 |
| 047 089 010856 | TRİFAZE SAYAÇ KUTUSU(540X350X130) MM | 1 ad. | | 93,759 |
| 047 089 010843 | LÜKS MONOFAZE DİJİTAL SAYAÇ KUTUSU | 1 ad. | | 25,160 |
| 047 089 010844 | LÜKS MONOFAZE DİJİTAL MEKANİK SAYAÇ KUTUSU | 1 ad. | | 25,478 |
| 047 089 010845 | LÜKS MONOFAZE DİJİTAL MEKANİK SAYAÇ KUTUSU S/A | 1 ad. | | 26,115 |
| 047 089 010841 | LÜKS TRİFAZE DİJİTAL MEKANİK SAYAÇ KUTUSU | 1 ad. | | 39,651 |
| DEVRE KESEN VE NH00 KAİDELER | | | | |
| 025 110 000001 | TRİFAZE DEVRE KESEN | 1 ad. | | 34,973 |
| 025 110 000002 | MONOFAZE DEVRE KESEN | 2 ad. | | 19,347 |
| 025 110 000003 | TEK KOFRA | 1 ad. | | 66,226 |
| 025 110 000004 | NH00 BOY KAİDE | 6 ad. | | 7,203 |
| 025 110 000005 | NH00 BOY BIÇAKLI SİĞ. (32A.-160A.) | 10 ad. | | 7,143 |
| 025 110 000025 | NH POLYESTER YER ALTI KOFRA (KESİCİLİ) | 1 ad. | | 218,768 |

COMFORT SİGORTA VE ZAYIF AKIM KUTULARIMIZ İLE
**KENDİNİZİ GÜVENDE
HİSSEDİN**



225x270(İç Ölçü)
Zayıf Akım Kut. (S/Ü)



12'li Sigorta+Zayıf Akım
Kutusu (S/Ü)



24'lü Sigorta+Zayıf Akım
Kutusu (S/Ü)



| Kod | Açıklama / Stok Cinsi | Amb. Kutu/Bağ | Amb. Kolu/Çv | FİYAT |
|--|--|---------------|--------------|--------|
| MEKSBOX W OTOMAT KUTULARI | | | | |
| IP30 | | | | |
| 001 027 200001 00 00 | MÜHÜRLÜ W OTOMAT KUTUSU (S/Ü) 1 Lİ | 20 ad. | 160 | 1,813 |
| 001 027 200002 00 00 | MÜHÜRLÜ W OTOMAT KUTUSU (S/Ü) 2 Lİ | 20 ad. | 80 | 2,534 |
| 001 027 200004 00 00 | MÜHÜRLÜ W OTOMAT KUTUSU (S/Ü) 4 LÜ | 10 ad. | 80 | 3,760 |
| 001 027 100002 00 00 | W OTOMAT KUTUSU (S/Ü) MEKSBOX 2 Lİ | 1 ad. | 30 | 9,084 |
| 001 027 000002 00 00 | W OTOMAT KUTUSU (S/A) MEKSBOX 2 Lİ | 1 ad. | 30 | 8,839 |
| 001 027 100004 00 00 | W OTOMAT KUTUSU (S/Ü) MEKSBOX 4 LÜ | 1 ad. | 20 | 10,790 |
| 001 027 000004 00 00 | W OTOMAT KUTUSU (S/A) MEKSBOX 4 LÜ | 1 ad. | 20 | 8,901 |
| 001 027 100006 00 00 | W OTOMAT KUTUSU (S/Ü) MEKSBOX 6 Lİ | 1 ad. | 20 | 14,098 |
| 001 027 000006 00 00 | W OTOMAT KUTUSU (S/A) MEKSBOX 6 Lİ | 1 ad. | 20 | 12,069 |
| 001 027 100009 00 00 | W OTOMAT KUTUSU (S/Ü) MEKSBOX 9 LU | 1 ad. | 20 | 19,183 |
| 001 027 000009 00 00 | W OTOMAT KUTUSU (S/A) MEKSBOX 9 LU | 1 ad. | 20 | 18,678 |
| 001 027 100012 00 00 | W OTOMAT KUTUSU (S/Ü) MEKSBOX 12 Lİ | 1 ad. | 10 | 23,239 |
| 001 027 000012 00 00 | W OTOMAT KUTUSU (S/A) MEKSBOX 12 Lİ | 1 ad. | 10 | 25,421 |
| 001 027 100016 00 00 | W OTOMAT KUTUSU (S/Ü) MEKSBOX 16 Lİ | 1 ad. | 10 | 30,810 |
| 001 027 000016 00 00 | W OTOMAT KUTUSU (S/A) MEKSBOX 16 Lİ | 1 ad. | 10 | 29,844 |
| 001 027 100024 00 00 | W OTOMAT KUTUSU (S/Ü) MEKSBOX 24 LÜ | 1 ad. | 5 | 42,722 |
| 001 027 000024 00 00 | W OTOMAT KUTUSU (S/A) MEKSBOX 24 LÜ | 1 ad. | 5 | 36,946 |
| 001 027 100036 00 00 | W OTOMAT KUTUSU (S/Ü) MEKSBOX 36 Lİ | 1 ad. | 5 | 56,772 |
| 001 027 000036 00 00 | W OTOMAT KUTUSU (S/A) MEKSBOX 36 Lİ | 1 ad. | 5 | 50,204 |
| MEKSBOX W OTOMAT KUTULARI (ALEV YAYMAYAN) | | | | |
| IP30 | | | | |
| 001 027 210001 00 00 | MÜH.W OTOMAT KUTUSU ALEV YAYMAYAN (S/Ü) 1 Lİ | 20 ad. | 160 | 3,691 |
| 001 027 210002 00 00 | MÜH.W OTOMAT KUTUSU ALEV YAYMAYAN (S/Ü) 2 Lİ | 20 ad. | 80 | 3,835 |
| 001 027 210004 00 00 | MÜH.W OTOMAT KUTUSU ALEV YAYMAYAN (S/Ü) 4 LÜ | 10 ad. | 80 | 6,230 |
| 001 027 110002 00 00 | W OTOMAT KUTUSU (S/Ü) ALEV YAYMAYAN 2 Lİ | 1 ad. | 30 | 12,542 |
| 001 027 010002 00 00 | W OTOMAT KUTUSU (S/A) ALEV YAYMAYAN 2 Lİ | 1 ad. | 30 | 12,308 |
| 001 027 110004 00 00 | W OTOMAT KUTUSU (S/Ü) ALEV YAYMAYAN 4 LÜ | 1 ad. | 20 | 16,826 |
| 001 027 010004 00 00 | W OTOMAT KUTUSU (S/A) ALEV YAYMAYAN 4 LÜ | 1 ad. | 20 | 15,976 |
| 001 027 110006 00 00 | W OTOMAT KUTUSU (S/Ü) ALEV YAYMAYAN 6 Lİ | 1 ad. | 20 | 21,909 |
| 001 027 010006 00 00 | W OTOMAT KUTUSU (S/A) ALEV YAYMAYAN 6 Lİ | 1 ad. | 20 | 16,511 |
| 001 027 110009 00 00 | W OTOMAT KUTUSU (S/Ü) ALEV YAYMAYAN 9 LU | 1 ad. | 20 | 29,214 |
| 001 027 010009 00 00 | W OTOMAT KUTUSU (S/A) ALEV YAYMAYAN 9 LU | 1 ad. | 20 | 27,841 |
| 001 027 110012 00 00 | W OTOMAT KUTUSU (S/Ü) ALEV YAYMAYAN 12 Lİ | 1 ad. | 10 | 36,572 |
| 001 027 010012 00 00 | W OTOMAT KUTUSU (S/A) ALEV YAYMAYAN 12 Lİ | 1 ad. | 10 | 28,933 |
| 001 027 110016 00 00 | W OTOMAT KUTUSU (S/Ü) ALEV YAYMAYAN 16 Lİ | 1 ad. | 10 | 44,345 |
| 001 027 010016 00 00 | W OTOMAT KUTUSU (S/A) ALEV YAYMAYAN 16 Lİ | 1 ad. | 10 | 33,678 |
| 001 027 110024 00 00 | W OTOMAT KUTUSU (S/Ü) ALEV YAYMAYAN 24 LÜ | 1 ad. | 5 | 65,997 |
| 001 027 010024 00 00 | W OTOMAT KUTUSU (S/A) ALEV YAYMAYAN 24 LÜ | 1 ad. | 5 | 63,692 |
| 001 027 110036 00 00 | W OTOMAT KUTUSU (S/Ü) ALEV YAYMAYAN 36 Lİ | 1 ad. | 5 | 94,459 |
| 001 027 010036 00 00 | W OTOMAT KUTUSU (S/A) ALEV YAYMAYAN 36 Lİ | 1 ad. | 5 | 70,435 |
| ÖRTME PARÇALARI | | | | |
| 001 026 000002 00 00 | W OTOMAT ÖRTME PARÇASI (12'Lİ) YENİ TİP | 50 ad. | 400 | 0,882 |



| Kod | Açıklama / Stok Cinsi | Amb. Kutu/Bağ | Amb. Kolu/Çv | FİYAT |
|---|---|---------------|--------------|------------|
| COMFORT W OTOMAT KUTULARI | | | | IP40 |
| 001 057 200001 00 00 | COMFORT MÜH. SIGORTA KUTUSU(S/Ü) 1 Lİ | 20 ad. | 120 | 2,42 |
| 001 057 200002 00 00 | COMFORT MÜH. SIGORTA KUTUSU(S/Ü) 1-2 Lİ | 20 ad. | 80 | 2,82 |
| 001 057 200004 00 00 | COMFORT MÜH. SIGORTA KUTUSU(S/Ü) 2-4 Lİ | 10 ad. | 60 | 3,55 |
| 001 057 100006 00 00 | COMFORT SIGORTA KUTUSU (S/Ü) 6 Lİ | 1 ad. | 20 | 16,59 |
| 001 057 100009 00 00 | COMFORT SIGORTA KUTUSU (S/Ü) 9 LÜ | 1 ad. | 20 | 19,58 |
| 001 057 100012 00 00 | COMFORT SIGORTA KUTUSU (S/Ü) 12 Lİ | 1 ad. | 10 | 26,47 |
| 001 057 100018 00 00 | COMFORT SIGORTA KUTUSU (S/Ü) 18 Lİ | 1 ad. | 10 | 38,27 |
| 001 057 100024 00 00 | COMFORT SIGORTA KUTUSU (S/Ü) 24 LÜ | 1 ad. | 5 | 44,79 |
| 001 057 100036 00 00 | COMFORT SIGORTA KUTUSU (S/Ü) 36 Lİ | 1 ad. | 5 | 58,59 |
| 001 057 000006 00 00 | COMFORT SIGORTA KUTUSU (S/A) 6 Lİ | 1 ad. | 20 | 16,00 |
| 001 057 000009 00 00 | COMFORT SIGORTA KUTUSU (S/A) 9 LÜ | 1 ad. | 20 | 19,12 |
| 001 057 000012 00 00 | COMFORT SIGORTA KUTUSU (S/A) 12 Lİ | 1 ad. | 10 | 25,70 |
| 001 057 000018 00 00 | COMFORT SIGORTA KUTUSU (S/A) 18 Lİ | 1 ad. | 10 | 36,06 |
| 001 057 000024 00 00 | COMFORT SIGORTA KUTUSU (S/A) 24 LÜ | 1 ad. | 5 | 43,90 |
| 001 057 000036 00 00 | COMFORT SIGORTA KUTUSU (S/A) 36 Lİ | 1 ad. | 5 | 57,32 |
| COMFORT W OTOMAT KUTULARI (ALEV YAYMAYAN) | | | | IP40 |
| 001 057 210001 00 00 | COMFORT MÜH. SIGORTA (A.YAYMAYAN)(S/Ü) 1 Lİ | 20 ad. | 120 | 3,20 |
| 001 057 210002 00 00 | COMFORT MÜH. SIGORTA (A.YAYMAYAN)(S/Ü) 1-2 Lİ | 20 ad. | 80 | 3,76 |
| 001 057 210004 00 00 | COMFORT MÜH. SIGORTA (A.YAYMAYAN)(S/Ü) 2-4 LÜ | 10 ad. | 60 | 4,91 |
| 001 057 110006 00 00 | COMFORT SIGORTA KUTUSU(S/Ü)(A.YAYMAYAN) 6 Lİ | 1 ad. | 20 | 21,70 |
| 001 057 110009 00 00 | COMFORT SIGORTA KUTUSU(S/Ü)(A.YAYMAYAN) 9 LÜ | 1 ad. | 20 | 26,64 |
| 001 057 110012 00 00 | COMFORT SIGORTA KUTUSU(S/Ü)(A.YAYMAYAN) 12 Lİ | 1 ad. | 10 | 36,66 |
| 001 057 110018 00 00 | COMFORT SIGORTA KUTUSU(S/Ü)(A.YAYMAYAN) 18 Lİ | 1 ad. | 10 | 54,24 |
| 001 057 110024 00 00 | COMFORT SIGORTA KUTUSU(S/Ü)(A.YAYMAYAN) 24 LÜ | 1 ad. | 5 | 61,20 |
| 001 057 110036 00 00 | COMFORT SIGORTA KUTUSU(S/Ü)(A.YAYMAYAN) 36 Lİ | 1 ad. | 5 | 76,98 |
| 001 057 010006 00 00 | COMFORT SIGORTA KUTUSU(S/A) A.YAYMAYAN 6 Lİ | 1 ad. | 20 | 21,07 |
| 001 057 010009 00 00 | COMFORT SIGORTA KUTUSU(S/A) A.YAYMAYAN 9 LÜ | 1 ad. | 20 | 25,79 |
| 001 057 010012 00 00 | COMFORT SIGORTA KUTUSU(S/A) A.YAYMAYAN 12 Lİ | 1 ad. | 10 | 35,29 |
| 001 057 010018 00 00 | COMFORT SIGORTA KUTUSU(S/A) A.YAYMAYAN 18 Lİ | 1 ad. | 10 | 50,31 |
| 001 057 010024 00 00 | COMFORT SIGORTA KUTUSU(S/A) A.YAYMAYAN 24 LÜ | 1 ad. | 5 | 58,38 |
| 001 057 010036 00 00 | COMFORT SIGORTA KUTUSU(S/A) A.YAYMAYAN 36 Lİ | 1 ad. | 5 | 74,30 |
| COMFORT W OTOMAT KUTULARI H.FREE (ALEV YAYAN) | | | | IP40 |
| 001 057 220001 00 00 | COMFORT MÜH. SIGORTA KUTUSU H.FREE (ALEV YAYAN)(S/Ü) 1 Lİ | 20 ad. | 120 | 2,61 |
| 001 057 220002 00 00 | COMFORT MÜH. SIGORTA KUTUSU H.FREE (ALEV YAYAN)(S/Ü) 1-2 Lİ | 20 ad. | 80 | 3,05 |
| 001 057 220004 00 00 | COMFORT MÜH. SIGORTA KUTUSU H.FREE (ALEV YAYAN)(S/Ü) 2-4 Lİ | 10 ad. | 60 | 3,83 |
| 001 057 120006 00 00 | COMFORT SIGORTA KUTUSU H.FREE (ALEV YAYAN) (S/Ü) 6 Lİ | 1 ad. | 20 | 18,27 |
| 001 057 120009 00 00 | COMFORT SIGORTA KUTUSU H.FREE (ALEV YAYAN) (S/Ü) 9 LÜ | 1 ad. | 20 | 21,57 |
| 001 057 120012 00 00 | COMFORT SIGORTA KUTUSU H.FREE (ALEV YAYAN) (S/Ü) 12 Lİ | 1 ad. | 10 | 29,16 |
| 001 057 120018 00 00 | COMFORT SIGORTA KUTUSU H.FREE (ALEV YAYAN) (S/Ü) 18 Lİ | 1 ad. | 10 | 42,16 |
| 001 057 120024 00 00 | COMFORT SIGORTA KUTUSU H.FREE (ALEV YAYAN) (S/Ü) 24 LÜ | 1 ad. | 5 | 49,57 |
| 001 057 120036 00 00 | COMFORT SIGORTA KUTUSU H.FREE (ALEV YAYAN) (S/Ü) 36 Lİ | 1 ad. | 5 | 64,84 |
| 001 057 020006 00 00 | COMFORT SIGORTA KUTUSU H.FREE (ALEV YAYAN) (S/A) 6 Lİ | 1 ad. | 20 | 17,62 |
| 001 057 020009 00 00 | COMFORT SIGORTA KUTUSU H.FREE (ALEV YAYAN) (S/A) 9 LÜ | 1 ad. | 20 | 21,06 |
| 001 057 020012 00 00 | COMFORT SIGORTA KUTUSU H.FREE (ALEV YAYAN) (S/A) 12 Lİ | 1 ad. | 10 | 28,31 |
| 001 057 020018 00 00 | COMFORT SIGORTA KUTUSU H.FREE (ALEV YAYAN) (S/A) 18 Lİ | 1 ad. | 10 | 39,72 |
| 001 057 020024 00 00 | COMFORT SIGORTA KUTUSU H.FREE (ALEV YAYAN) (S/A) 24 LÜ | 1 ad. | 5 | 48,58 |
| 001 057 020036 00 00 | COMFORT SIGORTA KUTUSU H.FREE (ALEV YAYAN) (S/A) 36 Lİ | 1 ad. | 5 | 63,43 |
| COMFORT W OTOMAT ZAYIF AKIM KUTULARI | | | | IP40 |
| 001 057 101012 00 00 | COMFORT ZAYIF AKIM KUTUSU (S/Ü)(225x270) | 1 ad. | 10 | 25,76 |
| 001 057 101020 00 00 | COMFORT ZAYIF AKIM KUTUSU (S/Ü)(270x340) | | | HAZIRLIKTA |
| 001 057 101024 00 00 | COMFORT 12 Lİ SIGORTA + ZAYIF AKIM KUTUSU (S/Ü) | 1 ad. | 5 | 45,08 |
| 001 057 101036 00 00 | COMFORT 24 LÜ SIGORTA + ZAYIF AKIM KUTUSU (S/Ü) | 1 ad. | 5 | 61,70 |
| 001 057 001012 00 00 | COMFORT ZAYIF AKIM KUTUSU (S/A)(205x250) | 1 ad. | 10 | 24,58 |
| 001 057 001020 00 00 | COMFORT ZAYIF AKIM KUTUSU (S/A)(243x318) | | | HAZIRLIKTA |
| 001 057 001024 00 00 | COMFORT 12 Lİ SIGORTA + ZAYIF AKIM KUTUSU (S/A) | 1 ad. | 5 | 43,68 |
| 001 057 001036 00 00 | COMFORT 24 LÜ SIGORTA + ZAYIF AKIM KUTUSU (S/A) | 1 ad. | 5 | 60,03 |
| COMFORT W OTOMAT ZAYIF AKIM KUTULARI H.FREE (ALEV YAYAN) | | | | IP40 |
| 001 057 121012 00 00 | COMFORT ZAYIF AKIM KUTUSU H.FREE (ALEV YAYAN) (S/Ü)(225x270) | 1 ad. | 10 | 27,82 |
| 001 057 121020 00 00 | COMFORT ZAYIF AKIM KUTUSU H.FREE (ALEV YAYAN) (S/Ü)(270x340) | | | HAZIRLIKTA |
| 001 057 121024 00 00 | COMFORT 12 Lİ SIGORTA + ZAYIF AKIM KUTUSU H.FREE (ALEV YAYAN) (S/Ü) | 1 ad. | 5 | 48,68 |
| 001 057 121036 00 00 | COMFORT 24 LÜ SIGORTA + ZAYIF AKIM KUTUSU H.FREE (ALEV YAYAN) (S/Ü) | 1 ad. | 5 | 66,64 |
| 001 057 021012 00 00 | COMFORT ZAYIF AKIM KUTUSU H.FREE (ALEV YAYAN) (S/A)(205x250) | 1 ad. | 10 | 26,55 |
| 001 057 021020 00 00 | COMFORT ZAYIF AKIM KUTUSU H.FREE (ALEV YAYAN) (S/A)(243x318) | | | HAZIRLIKTA |
| 001 057 021024 00 00 | COMFORT 12 Lİ SIGORTA + ZAYIF AKIM KUTUSU H.FREE (ALEV YAYAN) (S/A) | 1 ad. | 5 | 47,17 |
| 001 057 021036 00 00 | COMFORT 24 LÜ SIGORTA + ZAYIF AKIM KUTUSU H.FREE (ALEV YAYAN) (S/A) | 1 ad. | 5 | 64,84 |
| COMFORT W OTOMAT ZAYIF AKIM KUTULARI (ALEV YAYMAYAN) | | | | IP40 |
| 001 057 111012 00 00 | COMFORT ZAYIF AKIM KUTUSU(A.YAYMAYAN)(S/Ü)(225x270) | 1 ad. | 10 | 36,53 |
| 001 057 111020 00 00 | COMFORT ZAYIF AKIM KUTUSU(A.YAYMAYAN)(S/Ü)(270x340) | | | HAZIRLIKTA |
| 001 057 111024 00 00 | COMFORT 12 Lİ SIGORTA + ZAYIF AKIM KUTUSU(A.YAYMAYAN)(S/Ü) | 1 ad. | 5 | 55,99 |
| 001 057 111036 00 00 | COMFORT 24 LÜ SIGORTA + ZAYIF AKIM KUTUSU(A.YAYMAYAN)(S/Ü) | 1 ad. | 5 | 75,77 |
| 001 057 011012 00 00 | COMFORT ZAYIF AKIM KUTUSU(A.YAYMAYAN)(S/A)(205x250) | 1 ad. | 10 | 34,71 |
| 001 057 011020 00 00 | COMFORT ZAYIF AKIM KUTUSU(A.YAYMAYAN)(S/A)(243x318) | | | HAZIRLIKTA |
| 001 057 011024 00 00 | COMFORT 12 Lİ SIGORTA + ZAYIF AKIM KUTUSU(A.YAYMAYAN)(S/A) | 1 ad. | 5 | 55,33 |
| 001 057 011036 00 00 | COMFORT 24 LÜ SIGORTA + ZAYIF AKIM KUTUSU(A.YAYMAYAN)(S/A) | 1 ad. | 5 | 75,25 |
| COMFORT W OTOMAT KUTUSU AKSESUARLARI | | | | IP40 |
| 001 057 990001 00 00 | S/A COMFORT ALÇIPAN MONTAJ SETİ | 1 ad. | | 1,58 |
| 001 057 990002 00 00 | COMFORT SU TERAZİSİ | 1 ad. | | 3,50 |
| 000 700 000574 00 00 | RAY YÜKSELTME PARÇASI (UZUN/KISA) | 1 ad. | | 0,50 |

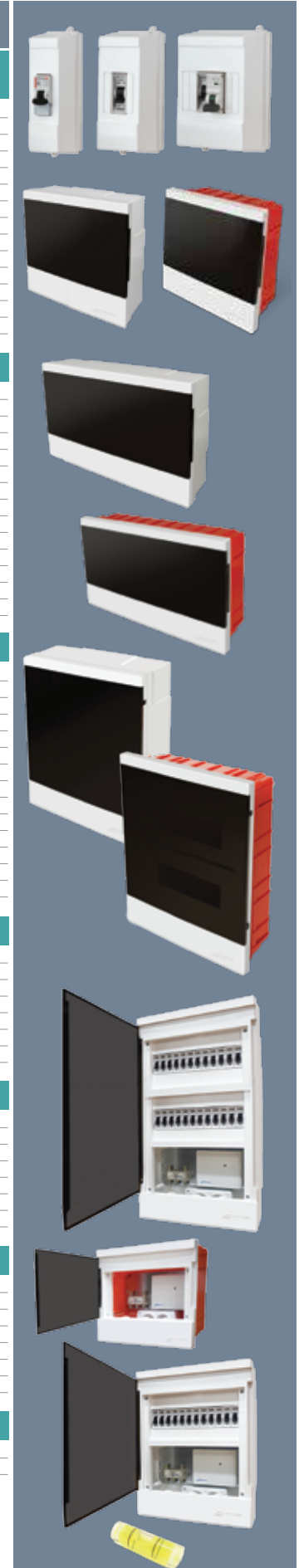



| Kod | Açıklama / Stok Cinsi | Amb. Kutu/Bağ | Amb. Kolu/Çvl | FİYAT |
|---|--|---------------|---------------|-----------|
| TELEFON DAĞITIM KUTULARI ve AKSESUARLARI | | | | |
| 001 049 001020 00 17 | TLF. DĞT. KUTUSU (10 - 20) BOŞ PLS. KLT | 2 ad. | 60 | 9,833 |
| 001 049 201020 00 17 | TLF.DĞT.KUTUSU(10-20)BOŞ PLS.(KİLİTLİ) (A. YAYMAYAN) | 2 ad. | 60 | 11,800 |
| 001 049 011020 00 17 | TLF. DĞT. KUTUSU (10 - 20) BOŞ KİLİTLİ | 2 ad. | 60 | 16,425 |
| 001 049 211020 00 17 | TLF.DĞT.KUTUSU(10-20)BOŞ(KİLİTLİ) (A. YAYMAYAN) | 2 ad. | 60 | 19,710 |
| 001 049 001050 00 17 | TLF. DĞT. KUTUSU(10-50) BOŞ PLS.KİLİT | 1 ad. | 28 | 20,448 |
| 001 049 201050 00 17 | TLF.DĞT.KUTUSU(10-50)BOŞ PLS.(KİLİTLİ) (A. YAYMAYAN) | 1 ad. | 28 | 24,538 |
| 001 049 011050 00 17 | TLF. DĞT. KUTUSU(10-50) KİLİTLİ | 1 ad. | 28 | 27,040 |
| 001 049 211050 00 17 | TLF.DĞT.KUTUSU(10-50)(KİLİTLİ) (A. YAYMAYAN) | 1 ad. | 28 | 32,447 |
| 061 049 015012 | H.TDK. (50 - 120) KİLİTLİ TİP. PER. BOŞ. | 1 ad. | 12 | 79,485 |
| 001 024 000001 00 00 | ÇATI (1 MODÜL İÇİN) | 1 ad. | 1000 | 1,227 |
| 001 024 000002 00 00 | ÇATI (2 MODÜL İÇİN) | 1 ad. | 500 | 2,453 |
| 001 024 000003 00 00 | ÇATI (3 MODÜL İÇİN) | 1 ad. | 400 | 3,836 |
| 001 024 000004 00 00 | ÇATI (4 MODÜL İÇİN) | 1 ad. | 300 | 5,124 |
| 001 024 000005 00 00 | ÇATI (5 MODÜL İÇİN) | 1 ad. | 200 | 6,412 |
| 001 024 000010 00 00 | ÇATI (10 MODÜL İÇİN) | 1 ad. | 100 | 12,267 |
| 888 049 050001 | KESMESİZ MODÜL | 10 ad. | 250 | 2,073 \$ |
| 888 049 050002 | KESMELİ MODÜL | 10 ad. | 250 | 2,883 \$ |
| 888 049 050003 | İRTİBATLAMA ALETİ | 1 ad. | 50 | 11,906 \$ |
| 031 049 040001 | DAİRE İÇİ TLF.DĞT. KUTUSU (TEK JAKLI) | 10 ad. | 50 | 0,595 \$ |
| 031 049 040002 | DAİRE İÇİ TLF.DĞT. KUTUSU (ÇİFT JAKLI) | 10 ad. | 50 | 0,685 \$ |
| 888 049 050005 | TELEFON SİRİAL KORDONU | 1 ad. | 100 | 0,815 \$ |
| 888 049 050006 | TELEFON KÖKEN KORDON (TEK JAKLI) | 1 ad. | 100 | 0,676 \$ |
| 888 049 050007 | TELEFON KÖKEN KORDON (ÇİFT JAKLI) | 1 ad. | 100 | 0,757 \$ |
| 888 101 010012 | DATA+TEL. SIKMA PENSESİ 8P6P | 1 ad. | 5 | 23,812 \$ |
| 888 049 050011 | VT4001 6P4C PLUG | 100 ad. | 1000 | 0,038 \$ |
| 888 049 050010 | VT4003 8P8C PLUG | 100 ad. | 1000 | 0,080 \$ |
| 888 049 050016 | VT4006 4P4C SPRAL KORUYUCU (FIRDÖNDÜ) | 1 ad. | 100 | 1,518 \$ |
| DUYLAR | | | | |
| 040 109 040002 | İTALYAN DUY E 27 | 50 ad. | | 2,024 |
| 040 109 040001 | İTALYAN DUY E 14 | 100 ad. | | 1,905 |
| 040 109 040005 | İTALYAN DUY RONDELASI E27 | 100 ad. | | 0,595 |
| 040 109 040003 | İTALYAN DUY RONDELASI E14 | 100 ad. | | 0,476 |
| 040 109 030004 | MİSFER E 27 BRONZ DUY | 50 ad. | | 5,358 |
| 040 109 030003 | MİSFER E 14 BRONZ DUY | 100 ad. | | 5,060 |
| 024 109 010008 | BAKALİT ASMA DUY | 50 ad. | | 1,711 |
| 039 109 010009 | PLASTİK MİNYONET DUY | 100 ad. | | 0,363 |
| 072 109 010001 | DUVAR DUY | 50 ad. | | 1,847 |
| 072 109 010002 | TAVAN DUY | 50 ad. | | 1,847 |
| 024 109 010004 | TAVAN GLOP DİBİ | 24 ad. | | 2,768 |
| 024 109 010003 | DUVAR GLOP DİBİ | 24 ad. | | 2,768 |
| 024 109 010005 | YAĞMUR DUY | 50 ad. | | 1,964 |
| FLORESANT SÖKETLER | | | | |
| 004 078 000001 | TMS TİPİ FLRS. TEKLİ (PLASTİK) | 50 tkm. | | 1,816 |
| 004 078 000002 | TMS TİPİ FLRS. SOKETİ ÇİFTLİ (PLASTİK) | 25 tkm. | | 4,762 |
| 004 078 000003 | TMS STARTER YUVASI (GEÇMELİ) | 100 ad. | | 0,566 |
| 001 078 010004 00 00 | FLORESANT TUTUCU AY AYAK (VİDALI TİP) | 250 ad. | | 0,135 |
| 004 078 000004 | STARTER YUVASI (VİDALI) | 100 ad. | | 1,250 |
| 072 078 010003 | SİMİT FLORESANT AY AYAK | 250 ad. | | 0,067 |
| 076 109 010007 | 32 W SİMİT KÜP DUY | 100 ad. | | 2,707 |
| 076 109 010006 | STARTER YUVALI KÜP DUY | 100 ad. | | 3,626 |
| FIŞ ÇEŞİTLERİ | | | | |
| 001 888 000001 00 00 | PRİZMATİK ÇOCUK KORUMA KAPAĞI | 100 ad. | | 2,200 |
| 999 999 000186 | 2 MT. KABLOLU BASKILI TEYP FIŞI | 1 ad. | | 5,060 |
| 024 109 060001 | DUY FIŞ PERÇİNLİ | 50 ad. | | 2,009 |
| 024 109 060002 | DUY PRİZ | 50 ad. | | 5,818 |
| 031 114 020005 | TV ERKEK FIŞ | 100 ad. | | 0,830 |
| 031 114 020006 | TV DIŞI FIŞ 2 | 100 ad. | | 0,830 |
| 031 114 000050 | OK-050 F KONNEKTÖR RG-6 | 100 ad. | | 0,534 |
| 031 114 000051 | OK-051 F KONNEKTÖR RG-59 | 100 ad. | | 0,554 |
| 031 114 000057 | OK-057 F ARA KONNEKTÖR | 100 ad. | | 0,778 |
| 031 114 000062 | OK-062İ 3RCA-3RCA ARA KABLO | 1 ad. | | 2,446 \$ |
| 031 114 000065 | OK-065İ SCART-3RCA ARA KABLO (İN) | 1 ad. | | 1,951 \$ |
| 031 114 000063 | OK-063İ SCART-SCART ARA KABLO | 1 ad. | | 2,112 \$ |
| 031 114 000088 | OK-88İ JAKLI TELEFON FIŞI | 50 ad. | | 0,978 \$ |
| 031 114 000082 | OK-082İ 6P4C DIŞI ARA ADAPTÖR | 1 ad. | | 2,103 \$ |

| Kod | Açıklama / Stok Cinsi | Amb. Kutu/Bağ | Amb. Koli/Cv | FİYAT |
|-----------------------------------|-----------------------------|---------------|--------------|-------|
| MUTLUSAN KONTROL KALEMLERİ | | | | |
| 104 119 000001 | JUMBO DÜZ KONTROL KALEMİ | 12 ad. | | 1,816 |
| 104 119 000002 | JUMBO YILDIZ KONTROL KALEMİ | 12 ad. | | 2,061 |
| 104 119 000003 | KOMBO DÜZ KONTROL KALEMİ | 12 ad. | | 2,208 |
| 104 119 000004 | KOMBO YILDIZ KONTROL KALEMİ | 12 ad. | | 2,520 |
| 104 119 500001 | LÜX DÜZ KONTROL KALEMİ | 12 ad. | | 7,441 |
| 104 119 500002 | LÜX YILDIZ KONTROL KALEMİ | 12 ad. | | 8,929 |

| | | | | |
|---------------------------------|--|-------|--|---------|
| VIP-TEC KOMBİNE PENSELER | | | | |
| 105 101 212160 | VT212160 VIP-TEC KOMBİNE PENSE 160MM | 6 ad. | | 58,070 |
| 105 101 212180 | VT212180 VIP-TEC KOMBİNE PENSE 180MM | 6 ad. | | 66,851 |
| 105 101 212200 | VT212200 VIP-TEC KOMBİNE PENSE 200MM | 6 ad. | | 78,042 |
| 105 101 213140 | VT213160 VIP-TEC YAN KESKİ 160MM | 6 ad. | | 59,648 |
| 105 101 213160 | VT213180 VIP-TEC YAN KESKİ 180MM | 6 ad. | | 69,589 |
| 105 101 200160 | VT200160 VIP-TEC PLATINIUM KOMBİNE PENSE 160MM | 6 ad. | | 67,893 |
| 105 101 200180 | VT200180 VIP-TEC PLATINIUM KOMBİNE PENSE 180MM | 6 ad. | | 73,220 |
| 105 101 201160 | VT201160 VIP-TEC PLATINIUM YAN KESKİ 160MM | 6 ad. | | 67,863 |
| 105 101 201180 | VT201180 VIP-TEC PLATINIUM YAN KESKİ 180MM | 6 ad. | | 73,310 |
| 105 119 210309 | VT210309 VIP-TEC MULTIBAG TORN.-PENSE TAKIMI (9 PRÇ) | 1 ad. | | 269,517 |
| 105 119 200309 | VT200309 VIP-TEC MULTIBAG TORN.-PENSE TAKIMI (9 PRÇ) | 1 ad. | | 324,521 |

| | | | | |
|-----------------------------|---|--------|--|--------|
| VIP-TEC TORNAVİDALAR | | | | |
| 105 101 610031 | VT6100/31 VIP-TEC DÜZ UÇLU TORNAVİDA 3.0X75MM | 12 ad. | | 6,310 |
| 105 101 610042 | VT6100/42 VIP-TEC DÜZ UÇLU TORNAVİDA 4.0X100MM | 12 ad. | | 10,685 |
| 105 101 610052 | VT6100/52 VIP-TEC DÜZ UÇLU TORNAVİDA 5.5X100MM | 12 ad. | | 12,382 |
| 105 101 610063 | VT6100/63 VIP-TEC DÜZ UÇLU TORNAVİDA 6.5X125MM | 12 ad. | | 15,686 |
| 105 101 620031 | VT6200/31 VIP-TEC YILDIZ UÇLU TORNAVİDA PH0X75MM | 12 ad. | | 6,965 |
| 105 101 620042 | VT6200/42 VIP-TEC YILDIZ UÇLU TORNAVİDA PH1X100MM | 12 ad. | | 10,656 |
| 105 101 620062 | VT6200/62 VIP-TEC YILDIZ UÇLU TORNAVİDA PH2X100MM | 12 ad. | | 13,692 |
| 105 101 620063 | VT6200/63 VIP-TEC YILDIZ UÇLU TORNAVİDA PH2X125MM | 12 ad. | | 15,329 |
| 105 101 607000 | VT6000/7ST1 VIP-TEC ART TORNAVİDA SETİ (7 PRÇ) | 1 ad. | | 82,983 |
| 105 119 006190 | VT6190 VIP-TEC DÜZ UÇLU KONTROL KALEMİ 3.5MM | 24 ad. | | 11,251 |
| 105 119 006191 | VT6191 VIP-TEC YILDIZ UÇLU KONTROL KALEMİ PH0 | 24 ad. | | 11,251 |
| 105 119 006192 | VT6192 VIP-TEC CEP KONTROL KALEMİ 4.0MM | 24 ad. | | 10,507 |
| 105 119 006193 | VT6193 VIP-TEC DÜZ UÇLU KONTROL KALEMİ 3.5MM | 24 ad. | | 11,638 |

| | | | | |
|-------------------------------------|---|--------|--|---------|
| VIPTEC 1000V İZOLELİ ALETLER | | | | |
| 105 101 201309 | VT201309 VIP-TEC 1000V İZOLELİ PENSE-TORN. ÇANTA (9 PRÇ) | 1 ad. | | 386,878 |
| 105 101 201310 | VT201310 VIP-TEC 1000V İZOLELİ PENSE-TORN. ÇANTA (10 PRÇ) | 1 ad. | | 598,949 |
| 105 101 210318 | VT210318 VIP-TEC MULTIBAG JUMBO TAKIM (9 PRÇ) | 1 ad. | | 649,043 |
| 105 101 810032 | VT8100/32 VIP-TEC 1000V İZOLELİ DÜZ UÇLU TORN. 3.0X100MM | 12 ad. | | 12,977 |
| 105 101 810042 | VT8100/42 VIP-TEC 1000V İZOLELİ DÜZ UÇLU TORN. 4.0X100MM | 12 ad. | | 17,412 |
| 105 101 810053 | VT8100/53 VIP-TEC 1000V İZOLELİ DÜZ UÇLU TORN. 5.5X125MM | 12 ad. | | 20,180 |
| 105 101 810064 | VT8100/64 VIP-TEC 1000V İZOLELİ DÜZ UÇLU TORN. 6.5X125MM | 12 ad. | | 24,466 |
| 105 101 820030 | VT8200/30 VIP-TEC 1000V İZOLELİ YILDIZ UÇLU TORN. PH0X60MM | 12 ad. | | 12,114 |
| 105 101 820041 | VT8200/41 VIP-TEC 1000V İZOLELİ YILDIZ UÇLU TORN. PH1X80MM | 12 ad. | | 16,222 |
| 105 101 820062 | VT8200/62 VIP-TEC 1000V İZOLELİ YILDIZ UÇLU TORN. PH2X100MM | 12 ad. | | 21,043 |
| 105 101 820084 | VT8200/84 VIP-TEC 1000V İZOLELİ YILDIZ UÇLU TORN. PH3X150MM | 12 ad. | | 32,086 |
| 105 101 205160 | VT205160 VIP-TEC 1000V İZOLELİ KOMBİNE PENSE 160MM | 6 ad. | | 77,090 |
| 105 101 205180 | VT205180 VIP-TEC 1000V İZOLELİ KOMBİNE PENSE 180MM | 6 ad. | | 81,614 |
| 105 101 206160 | VT206160 VIP-TEC 1000V İZOLELİ YAN KESKİ 160MM | 6 ad. | | 77,090 |
| 105 101 206180 | VT206180 VIP-TEC 1000V İZOLELİ YAN KESKİ 180MM | 6 ad. | | 79,947 |
| 105 101 208160 | VT208160 VIP-TEC 1000V İZOLELİ EĞRİ KARGABURNU 160MM | 6 ad. | | 70,780 |

| | | | | |
|-----------------------------------|--|-------|--|-----------|
| VIPTEC METAL TAKIM ÇANTASI | | | | |
| 105 101 105051 | VT895105D-51 ELEKTRİKÇİ TİP METAL TAKIM ÇANTASI (51 PRÇ) | 1 ad. | | 1,314,605 |

| | | | | |
|---|--|-------|--|----------|
| JOKARI KABLO SİYIRMA VE KESME İÇİN EV ALETLERİ | | | | |
| 129 087 000351 | 10160 4-16MM TÜM YUVARLAK KABLO KILIFLARINI SOYMAK İÇİN | 1 ad. | | 19,310 € |
| 129 087 000355 | 10282 8-28MM TÜM YUVARLAK KABLO KILIFLARINI SOYMAK İÇİN | 1 ad. | | 19,310 € |
| 129 087 000356 | 10350 27-35MM TÜM YUVARLAK KABLO KILIFLARINI SOYMAK İÇİN | 1 ad. | | 30,155 € |
| 129 087 000359 | 20050 MAX.2,5MMYE KADAR OLAN İLETKENLER İÇİN.UZUNLUK STOPU 6-15MM ARASI AYARLANABİLİR. | 1 ad. | | 27,444 € |

| | | | | |
|----------------------------------|---|--------|--|----------|
| KONTROL KALEMLERİ (İTHAL) | | | | |
| 888 119 010003 | FHT-159 VOL.TEST K.KALEMİAC/DC 100-250V | 12 ad. | | 0,828 \$ |
| 888 119 010007 | FHT-608 VOL.TEST K.KALEMİAC/DC 100-250V | 12 ad. | | 1,663 \$ |
| 888 119 010006 | FHT-304C VOL.TEST K.KALEMİAC/DC 100-250V | 12 ad. | | 0,656 \$ |
| 888 119 010010 | FHT-2006 VOL.TEST K.KAL.AC 110/220/380V | 10 ad. | | 3,219 \$ |
| 888 119 010011 | FHT-9818 VOLTAJ TEST KONTROL KALEMİ | 25 ad. | | 2,241 \$ |
| 888 119 010001 | FHT-023 KONTROL KALEMİ TAKIM KUTUSU | 1 ad. | | 1,719 \$ |
| 888 119 010004 | FHT-232 VOL.TEST K.KALEMİAC/DC 100-250V | 20 ad. | | 1,250 \$ |
| 888 119 010005 | FHT-233 VOL.TEST K.KALEMİAC/DC 100-250V | 20 ad. | | 1,219 \$ |
| 888 119 010009 | FHT-828R DİJ.VOLT.TEST.12,36,55,110,220V | 50 ad. | | 1,622 \$ |
| 888 119 010014 | FHT-611 İNCE TİP KONT.KALEMİ YILDIZ AC/DC 100-500V | 1 ad. | | 0,875 \$ |
| 888 119 010015 | FHT-602 KALIN TİP KONT.KALEMİ DÜZ AC/DC 100-500V | 1 ad. | | 0,938 \$ |
| 888 119 010016 | FHT-612 KALIN TİP KONT.KALEMİ YILDIZ AC/DC 100-500V | 1 ad. | | 0,938 \$ |
| 888 119 010018 | FHT-958 KOPIK HAT DEDEKTÖRÜ | 1 ad. | | 6,147 \$ |

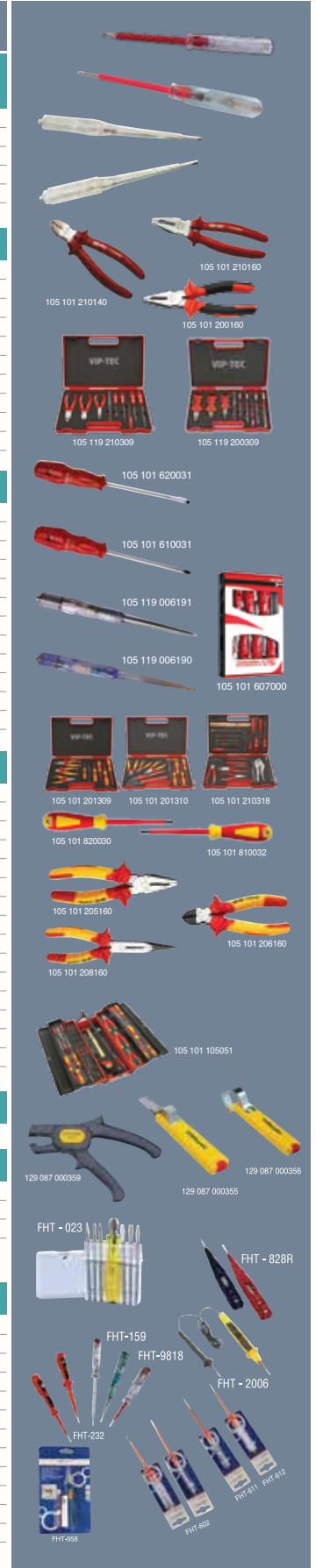



| Kod | Açıklama / Stok Cinsi | Amb. (Kutu/Bağ) | Amb. (Koli/Çv.) | FİYAT |
|---|--|--------------------|--------------------|-------|
| MUTLUSAN BETON ÇİVİLİ KROŞELER | | | | |
| 032 048 070000 | NO:0 BETON ÇİVİLİ KROŞE(0.75 YASSIKORD.) | MUTLUSAN | 1000ad. 30000 | 0,022 |
| 032 048 070001 | NO:1 BETON ÇİVİLİ KROŞE(0.75 YASSIKORD.) | MUTLUSAN | 1000ad. 30000 | 0,022 |
| 032 048 070002 | NO:2 BETON ÇİVİLİ KROŞE(0.75 YASSIKORD.) | MUTLUSAN | 1000ad. 20000 | 0,022 |
| 032 048 070003 | NO. 3 BETON ÇİVİLİ KROŞE (2X1.5-3X1.5) | MUTLUSAN | 1000ad. 20000 | 0,028 |
| 032 048 070004 | NO. 4 BETON ÇİVİLİ KROŞE (2X4) | MUTLUSAN | 1000ad. 20000 | 0,028 |
| 032 048 070005 | NO. 5 BETON ÇİVİLİ KROŞE (2X4-4X4) | MUTLUSAN | 1000ad. 10000 | 0,041 |
| 032 048 070006 | NO. 6 BETON ÇİVİLİ KROŞE (2X6) | MUTLUSAN | 1000ad. 10000 | 0,041 |
| 032 048 070007 | NO. 7 BETON ÇİVİLİ KROŞE (4X10) | MUTLUSAN | 1000ad. 8000 | 0,084 |
| 032 048 070008 | NO. 8 BETON ÇİVİLİ KROŞE (3X16+10) | MUTLUSAN | 1000ad. 5000 | 0,095 |
| BETON ÇİVİLİ KROŞELER (NETSAN) | | | | |
| 032 048 090000 | NO:0 BETON ÇİVİLİ KROŞE(0.75 YASSIKORD.) | NETSAN | 1000ad. 20000 | 0,026 |
| 032 048 090001 | NO:1 BETON ÇİVİLİ KROŞE(0.75 YASSIKORD.) | NETSAN | 1000ad. 20000 | 0,026 |
| 032 048 090002 | NO:2 BETON ÇİVİLİ KROŞE(0.75 YASSIKORD.) | NETSAN | 1000ad. 20000 | 0,026 |
| 032 048 090003 | NO. 3 BETON ÇİVİLİ KROŞE (2X1.5-3X1.5) | NETSAN | 1000ad. 20000 | 0,034 |
| 032 048 090004 | NO. 4 BETON ÇİVİLİ KROŞE (2X4) | NETSAN | 1000ad. 20000 | 0,034 |
| 032 048 090005 | NO. 5 BETON ÇİVİLİ KROŞE (2X4-4X4) | NETSAN | 1000ad. 10000 | 0,049 |
| 032 048 090006 | NO. 6 BETON ÇİVİLİ KROŞE (2X6) | NETSAN | 1000ad. 10000 | 0,049 |
| 032 048 090007 | NO. 7 BETON ÇİVİLİ KROŞE (4X10) | NETSAN | 1000ad. 5000 | 0,100 |
| 032 048 090008 | NO. 8 BETON ÇİVİLİ KROŞE (3X16+10) | NETSAN | 1000ad. 5000 | 0,123 |
| BETON ÇİVİLİ KROŞELER (GÖÇMEN) | | | | |
| 032 048 080000 | NO:0 BETON ÇİVİLİ KROŞE(0.75 YASSIKORD.) | GÖÇMEN | 1000ad. 40000 | 0,029 |
| 032 048 080001 | NO:1 BETON ÇİVİLİ KROŞE(0.75 YASSIKORD.) | GÖÇMEN | 1000ad. 40000 | 0,029 |
| 032 048 080002 | NO:2 BETON ÇİVİLİ KROŞE(0.75 YASSIKORD.) | GÖÇMEN | 1000ad. 40000 | 0,029 |
| 032 048 080003 | NO. 3 BETON ÇİVİLİ KROŞE (2X1.5-3X1.5) | GÖÇMEN | 1000ad. 24000 | 0,038 |
| 032 048 080004 | NO. 4 BETON ÇİVİLİ KROŞE (2X4) | GÖÇMEN | 1000ad. 24000 | 0,038 |
| 032 048 080005 | NO. 5 BETON ÇİVİLİ KROŞE (2X4-4X4) | GÖÇMEN | 1000ad. 20000 | 0,051 |
| 032 048 080006 | NO. 6 BETON ÇİVİLİ KROŞE (2X6) | GÖÇMEN | 1000ad. 18000 | 0,051 |
| 032 048 080007 | NO. 7 BETON ÇİVİLİ KROŞE (4X10) | GÖÇMEN | 800 ad. 10000 | 0,102 |
| 032 048 080008 | NO. 8 BETON ÇİVİLİ KROŞE (3X16+10) | GÖÇMEN | 400 ad. 4800 | 0,143 |
| 032 048 080009 | NO. 9 BETON ÇİVİLİ KROŞE (3X25+16) | GÖÇMEN | 400 ad. 4800 | 0,190 |
| GALVANİZLİ SAÇ KROŞELER | | | | |
| 001 048 060001 00 00 | NO. 1 TEKLİ GALVANİZ SAÇ KROŞE 12MM | | 1500ad. | 0,088 |
| 001 048 060002 00 00 | NO. 2 TEKLİ GALVANİZ SAÇ KROŞE 14MM | | 1000ad. | 0,082 |
| 001 048 060003 00 00 | NO. 3 TEKLİ GALVANİZ SAÇ KROŞE 17MM | | 700ad. | 0,103 |
| 001 048 060004 00 00 | NO. 4 TEKLİ GALVANİZ SAÇ KROŞE 20MM | | 500ad. | 0,126 |
| 001 048 060007 00 00 | NO. 7 TEKLİ GALVANİZ SAÇ KROŞE 26MM | | 350ad. | 0,168 |
| 001 048 060008 00 00 | NO. 8 TEKLİ GALVANİZ SAÇ KROŞE 34MM | | 250ad. | 0,250 |
| 001 048 060009 00 00 | NO. 9 TEKLİ GALVANİZ SAÇ KROŞE 43MM | | 200ad. | 0,327 |
| 001 048 060010 00 00 | NO. 10 TEKLİ GALVANİZ SAÇ KROŞE 53MM | | 150ad. | 0,377 |
| 001 048 060011 00 00 | NO. 11 TEKLİ GALVANİZ SAÇ KROŞE 55MM | | 120ad. | 0,461 |
| 001 048 070002 00 00 | NO. 2 ÇİFTLİ GALVANİZ SAÇ KROŞE 13MM | | 600ad. | 0,108 |
| 001 048 070003 00 00 | NO. 3 ÇİFTLİ GALVANİZ SAÇ KROŞE 16MM | | 500ad. | 0,127 |
| 001 048 070004 00 00 | NO. 4 ÇİFTLİ GALVANİZ SAÇ KROŞE 22MM | | 400ad. | 0,143 |
| 001 048 070007 00 00 | NO. 7 ÇİFTLİ GALVANİZ SAÇ KROŞE 25MM | | 400ad. | 0,174 |
| 001 048 070008 00 00 | NO. 8 ÇİFTLİ GALVANİZ SAÇ KROŞE 35MM | | 300ad. | 0,316 |
| 001 048 070009 00 00 | NO. 9 ÇİFTLİ GALVANİZ SAÇ KROŞE 45MM | | 200ad. | 0,395 |
| 001 048 070010 00 00 | NO. 10 ÇİFTLİ GALVANİZ SAÇ KROŞE 50MM | | 150ad. | 0,462 |
| 001 048 070011 00 00 | NO. 11 ÇİFTLİ GALVANİZ SAÇ KROŞE 55MM | | 100ad. | 0,537 |
| P KLİPS ÇEŞİTLERİ | | | | |
| 106 048 000001 | P-1 KLİPS 7mm | | 100 ad. | 0,446 |
| 106 048 000002 | P-2 KLİPS 10mm | | 100 ad. | 0,461 |
| 106 048 000003 | P-3 KLİPS 14mm | | 100 ad. | 0,476 |
| 106 048 000004 | P-4 KLİPS 16mm | | 100 ad. | 0,506 |
| 106 048 000005 | P-5 KLİPS 21mm | | 100 ad. | 0,536 |
| 106 048 000006 | P-6 KLİPS 28mm | | 100 ad. | 0,580 |
| 106 048 000007 | P-7 KLİPS 35mm | | 100 ad. | 0,640 |
| 106 048 000008 | P-8 KLİPS 42mm | | 100 ad. | 0,699 |
| 106 048 000009 | P-9 KLİPS 55mm | | 100 ad. | 0,804 |
| 106 048 000010 | P-10 KLİPS 60mm | | 100 ad. | 0,833 |
| RAY KROŞE VE TANDIR KROŞELER | | | | |
| 035 048 100001 | NO. 1 RAY KROŞE (2X1.5-4X2.5) | | 350 ad. | 0,426 |
| 035 048 100002 | NO. 2 RAY KROŞE (4X4-4X16) | | 250 ad. | 0,443 |
| 001 025 010100 00 00 | GALVANİZ KROŞE RAYI (1M) | | 50 ad. | 3,576 |
| 035 048 110001 | NO. 1 TANDIR KROŞE (2X1.5-2X6) | | 350 ad. | 0,327 |
| 035 048 110002 | NO. 2 TANDIR KROŞE (4X6) | | 250 ad. | 0,327 |
| 035 048 110003 | NO. 3 TANDIR KROŞE (4X10) | | 250 ad. | 0,327 |
| 035 048 110004 | NO. 4 TANDIR KROŞE (4X16) | | 150 ad. | 0,405 |
| 035 048 110005 | NO. 5 TANDIR KROŞE (3X25+16) | | 150 ad. | 0,405 |

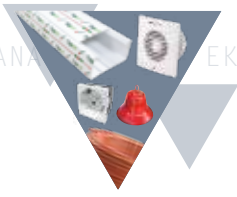

| Kod | Açıklama / Stok Cinsi | Amb. Kutu/Bağ | Amb. Koli/Çvl | FİYAT |
|-------------------------|-------------------------------|---------------|---------------|-------|
| PLASTİK DÜBELLER | | | | |
| 016 053 000014 | BURGULU ALÇIBAN DÜBELİ (YENİ) | 100 ad. | 10000 | 0,096 |
| 016 053 308100 | 8X100MM BOŞLUK DÜBELİ | 100 ad. | 10000 | 0,123 |
| 001 053 000001 00 00 | ALÇIPAN DÜBEL | 100 ad. | 15000 | 0,137 |
| 016 053 100002 | MEGA DÜBEL | 1000ad. | 14000 | 0,071 |
| 001 053 000002 00 00 | KANAL DÜBELİ | 1000ad. | 14000 | 0,066 |
| 888 129 080185 | DÜBELLLİ KABLO BAĞI 8X18,5 | 100 ad. | 1700 | 0,209 |
| 001 053 000005 00 00 | KORNİŞ DÜBELİ | 1000ad. | 14000 | 0,069 |
| 016 053 000006 | 6 MM BEYAZ DÜBEL | 1000ad. | 35000 | 0,020 |
| 016 053 000007 | 7 MM BEYAZ DÜBEL | 1000ad. | 25000 | 0,021 |
| 016 053 000008 | 8 MM BEYAZ DÜBEL | 1000ad. | 20000 | 0,022 |
| 016 053 000010 | 10 MM BEYAZ DÜBEL | 1000ad. | 10000 | 0,050 |
| 016 053 000012 | 12 MM BEYAZ DÜBEL | 250 ad. | 2500 | 0,113 |
| 016 053 000106 | 6 MM RENKLİ DÜBEL (YEŞİL) | 1000ad. | 35000 | 0,020 |
| 016 053 000107 | 7 MM RENKLİ DÜBEL (SARI) | 1000ad. | 25000 | 0,023 |
| 016 053 000108 | 8 MM RENKLİ DÜBEL (KIRMIZI) | 1000ad. | 10000 | 0,025 |
| 016 053 000110 | 10 MM RENKLİ DÜBEL (MAVİ) | 1000ad. | 10000 | 0,052 |
| 016 053 300008 | 8 MM ROKET DÜBEL | 1000ad. | 20000 | 0,070 |
| 016 053 300010 | 10 MM ROKET DÜBEL | 500 ad. | 10000 | 0,105 |

| DÜBELLİ KROŞELER | | | | |
|-------------------------|--------------------------|---------|-------|-------|
| 001 048 090002 00 17 | 3/13 TEKLİ KABLO KROŞESİ | 500 ad. | 10000 | 0,044 |
| 001 048 090006 00 17 | 8/28 TEKLİ KABLO KROŞESİ | 500 ad. | 5000 | 0,064 |
| 001 048 090001 00 00 | ÇİFTLİ KABLO KROŞESİ | 100 ad. | 2500 | 0,071 |
| 001 048 090003 00 17 | 16'LIK BORU KELEPÇESİ | 100 ad. | 2000 | 0,106 |
| 001 048 090004 00 17 | 20'LIK BORU KELEPÇESİ | 100 ad. | 1500 | 0,129 |
| 001 048 090005 00 17 | 25'LIK BORU KELEPÇESİ | 100 ad. | 1000 | 0,169 |

| ANTİGRON KROŞELER | | | | |
|--------------------------|--|---------|------|-------|
| 128 048 000001 | NO:1 ANT. KROŞE(2X1.5-2X2.5-3X1.5-3X2.5) | 100 ad. | 3000 | 0,179 |
| 128 048 000015 | NO: 1.5 ANTİGRON KROŞE (2X4-2X6-4X4-4X6) | 100 ad. | 2000 | 0,193 |
| 128 048 000002 | NO: 2 ANTİGRON KROŞELER (4X10) | 100 ad. | 1500 | 0,295 |
| 128 048 000003 | NO: 3 ANTİGRON KROŞELER (4X16-3X25+16) | 50 ad. | 800 | 0,446 |

| KANCA VİDALAR | | | | |
|----------------------|-------------------|--------|--|--------|
| 013 099 031860 | 18X60 KANCA VİDA | 1 grs. | | 23,311 |
| 013 099 031960 | 19X60 KANCA VİDA | 1 grs. | | 30,122 |
| 013 099 031970 | 19X70 KANCA VİDA | 1 grs. | | 31,693 |
| 013 099 032060 | 20X60 KANCA VİDA | 1 grs. | | 33,396 |
| 013 099 032070 | 20X70 KANCA VİDA | 1 grs. | | 34,705 |
| 013 099 032080 | 20X80 KANCA VİDA | 1 grs. | | 24,883 |
| 013 099 032180 | 21X80 KANCA VİDA | 1 grs. | | 28,157 |
| 013 099 021100 | 21X100 KANCA VİDA | 1 grs. | | 16,370 |

| YILDIZ BAŞLI AĞAÇ VİDALARI | | | | |
|-----------------------------------|-------------------------|---------|--|--------|
| 013 099 011930 | 19X30 VİDA YILDIZ BAŞLI | 12 grs. | | 7,530 |
| 013 099 011935 | 19X35 VİDA YILDIZ BAŞLI | 12 grs. | | 8,382 |
| 013 099 011940 | 19X40 VİDA YILDIZ BAŞLI | 12 grs. | | 9,167 |
| 013 099 012020 | 20X20 VİDA YILDIZ BAŞLI | 12 grs. | | 7,203 |
| 013 099 012025 | 20X25 VİDA YILDIZ BAŞLI | 12 grs. | | 7,858 |
| 013 099 012030 | 20X30 VİDA YILDIZ BAŞLI | 12 grs. | | 9,167 |
| 013 099 012035 | 20X35 VİDA YILDIZ BAŞLI | 12 grs. | | 10,150 |
| 013 099 012040 | 20X40 VİDA YILDIZ BAŞLI | 12 grs. | | 11,132 |
| 013 099 012045 | 20X45 VİDA YILDIZ BAŞLI | 12 grs. | | 12,376 |
| 013 099 012050 | 20X50 VİDA YILDIZ BAŞLI | 12 grs. | | 13,293 |
| 013 099 012060 | 20X60 VİDA YILDIZ BAŞLI | 12 grs. | | 15,716 |

| SUNTA VİDASI ÇİNKO KAPLAMA | | | | |
|-----------------------------------|--|--------|--|--------|
| 013 099 043535 | 3,5X35 SUNTA VİDASI (1000 ADET FİYATI) | 1 grs. | | 52,123 |
| 013 099 043540 | 3,5X40 SUNTA VİDASI (500 ADET FİYATI) | 1 grs. | | 28,485 |
| 013 099 040425 | 4X25 SUNTA VİDASI (500 ADET FİYATI) | 1 grs. | | 26,062 |
| 013 099 040430 | 4X30 SUNTA VİDASI (500 ADET FİYATI) | 1 grs. | | 29,139 |
| 013 099 040435 | 4X35 SUNTA VİDASI (500 ADET FİYATI) | 1 grs. | | 32,479 |
| 013 099 040440 | 4X40 SUNTA VİDASI (500 ADET FİYAT) | 1 grs. | | 36,932 |
| 013 099 040445 | 4X45 SUNTA VİDASI (500ADET FİYAT) | 1 grs. | | 39,158 |
| 013 099 040460 | 4X60 SUNTA VİDASI (200 ADET FİYATI) | 1 grs. | | 19,645 |
| 013 099 040450 | 4X50 SUNTA VİDASI (500 ADET FİYATI) | 1 grs. | | 42,301 |
| 013 099 044460 | 4,5X60 SUNTA VİDASI (200 ADET FİYATI) | 1 grs. | | 24,228 |
| 013 099 044530 | 4,5X30 SUNTA VİDASI (500 ADET FİYATI) | 1 grs. | | 46,385 |
| 013 099 044535 | 4,5X35 SUNTA VİDASI (200 ADET FİYATI) | 1 grs. | | 16,370 |
| 013 099 044540 | 4,5X40 SUNTA VİDASI (200 ADET FİYATI) | 1 grs. | | 17,680 |
| 013 099 044545 | 4,5X45 SUNTA VİDASI (200 ADET FİYATI) | 1 grs. | | 19,121 |
| 013 099 044550 | 4,5X50 SUNTA VİDASI (200 ADET FİYATI) | 1 grs. | | 21,216 |
| 013 099 040530 | 5X30 SUNTA VİDASI (200 ADET FİYATI) | 1 grs. | | 16,894 |
| 013 099 040535 | 5X35 SUNTA VİDASI (200 ADET FİYATI) | 1 grs. | | 20,496 |
| 013 099 040540 | 5X40 SUNTA VİDASI (200 ADET FİYATI) | 1 grs. | | 21,609 |
| 013 099 040545 | 5X45 SUNTA VİDASI (200 ADET FİYATI) | 1 grs. | | 24,228 |
| 013 099 040550 | 5X50 SUNTA VİDASI (200 ADET FİYATI) | 1 grs. | | 27,699 |
| 013 099 040560 | 5X60 SUNTA VİDASI (200 ADET FİYATI) | 1 grs. | | 29,663 |

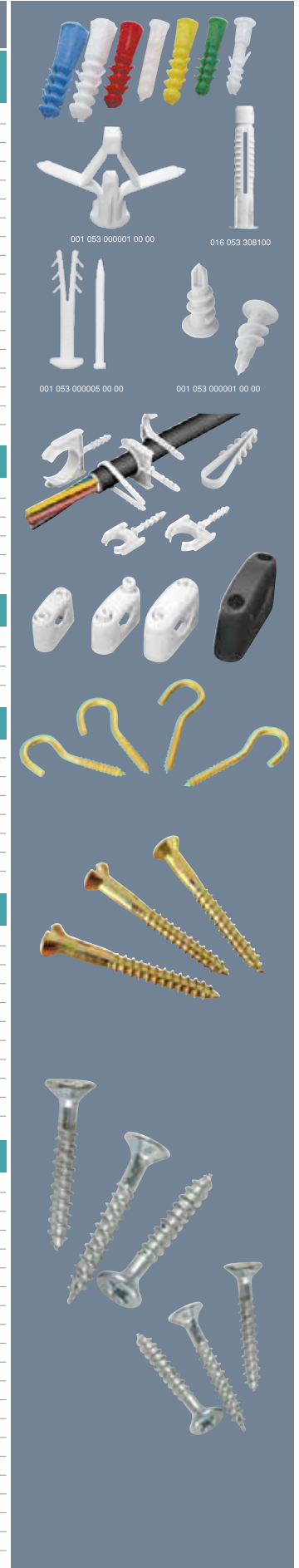



| Kod | Açıklama / Stok Cinsi | Amb. (Kutu/Bag) | Amb. (Koli/Çvt.) | FİYAT |
|---|--|-----------------|------------------|---------|
| GEÇMELİ BUAT KLEMENSLERİ €€ | | | | |
| 888 094 260802 | BM802 GEÇMELİ BUAT KLEMENSİ (2'Lİ) | 400 | 6400 | 0,139\$ |
| 888 094 260803 | BM803 GEÇMELİ BUAT KLEMENSİ (3'Lİ) | 300 | 4800 | 0,197\$ |
| 888 094 260804 | BM804 GEÇMELİ BUAT KLEMENSİ (4'Lİ) | 200 | 3200 | 0,239\$ |
| 888 094 260805 | BM805 GEÇMELİ BUAT KLEMENSİ (5'Lİ) | 200 | 3200 | 0,277\$ |
| 015 094 160001 | NO. 2 ZEYTİN (BUAT) KLEMENS | 1000 | 5000 | 0,104 |
| WAGO BUAT KLEMENSLERİ €€ | | | | |
| 999 094 280225 | 2X2.5 MM WAGO BUAT KLEMENSİ | 1000 | ad. | 0,680 |
| 999 094 280325 | 3X2.5 MM WAGO BUAT KLEMENSİ | 1000 | ad. | 0,760 |
| 999 094 280425 | 4X2.5 MM WAGO BUAT KLEMENSİ | 1000 | ad. | 0,940 |
| 999 094 280525 | 5X2.5 MM WAGO BUAT KLEMENSİ | 1000 | ad. | 1,020 |
| 999 094 280825 | 8X2.5 MM WAGO BUAT KLEMENSİ | 500 | ad. | 2,260 |
| WAGO KOMPAKT ÇOK AMAÇLI KLEMENS €€ | | | | |
| 999 094 300412 | 221-412 İKİLİ ÇOK AMAÇLI KOMPAKT KLEMENS | 1000 | ad. | 1,630 |
| 999 094 300413 | 221-413 ÜÇLÜ ÇOK AMAÇLI KOMPAKT KLEMENS | 500 | ad. | 2,080 |
| 999 094 300415 | 221-415 BEŞLİ ÇOK AMAÇLI KOMPAKT KLEMENS | 250 | ad. | 3,310 |

- Nominal akım: 32 A
- Nominal gerilim: 450 V
- Yüksek sıcaklıklar için:
 - Sürekli çalışma sıcaklığı: maks. 105 °C
 - Ortam sıcaklığı: maks. 85 °C (T85)

- 0.14-4 mm² (24-12 AWG)
- 0.2-4 mm² (24-12 AWG)



Tornavida
Yok
+ Tüm kablo
+ Tipleri için
+ 100%
Güvenli



WAGO ÖLÇÜM ALETLERİ



KOD: : 999 094 310810
ÜRÜN ADI : 206-810 MULTİMETRE
FİYAT : 190,78 EURO

- AC-DC True-RMS
- Data-Hold Fonksiyonu, diyet test fonksiyonu, buzzer
- 0,01 A -60/600 DC A aralığı seçimi
- 0,01 A -600 AC A aralığı seçimi 40-400Hz arası
- 600mV 600V AC/DC 40-400Hz arası ölçüm seçimi
- Frekans ölçümü Clamp ile 600Hz - 1KHz(>1A)
- Frekans ölçümü Prob ile 600Hz - 10KHz
- 60 Megaohm a kadar direnç, 60mF a kadar kapasite ölçümü
- 4 Dijit LCD Ekran ve otomatik kapanma fonksiyonu
- LED Lamba ile aydınlanma
- CAT III 600 V ve IP44
- TÜV/GS onaylı, IEC/EN 61010-1 (DIN VDE 0411)
- 5 YIL GARANTİ



KOD: : 999 094 310315
ÜRÜN ADI : 206-315 CLAMP AMPER METRE
FİYAT : 190,78 EURO

- AC-DC True-RMS Akım ölçümü
- Data-Hold Fonksiyonu
- Max. kablı çapı ø 21 mm
- Dar alanlarda rahat kullanım için küçük boyutlar
- 0,01 A -40 A aralığı seçim yada
- 0,1 A -200 A aralığı seçim
- Saniyede 3 kez deger yenileme
- Otomatik kapanma fonksiyonu
- CAT III 300 V ve IP44
- TÜV/GS onaylı
- IEC/EN 61010-1 (DIN VDE 0411)
- 5 YIL GARANTİ



KOD: : 999 094 310816
ÜRÜN ADI : 06-816 CLAMP AMPER METRE
FİYAT : 298,45 EURO

- AC-DC True-RMS Akım/Gerilim ölçümlü multimetre
- Data-Hold Fonksiyonu, diyet test fonksiyonu, buzzer
- 0,01 A -60/600 DC A aralığı seçimi
- 0,01 A -600 AC A aralığı seçimi 40 -400Hz arası
- 600m V-600V AC/DC 40 -400Hz arası ölçüm seçimi
- Frekans ölçümü Clamp ile 600Hz - 1KHz (>1A)
- Frekans ölçümü Prob ile 600Hz - 10KHz
- 60 Megaohm a kadar direnç, 60mF a kadar kapasitör ölçümü
- 4 Dijit LCD Ekran ve otomatik kapanma fonksiyonu
- LED lamba ile aydınlatma
- CAT III 600 V ve IP44
- TÜV/GS onaylı, IEC/EN 61010-1 (DIN VDE 0411)
- 5 YIL GARANTİ



KOD: : 999 094 310806
ÜRÜN ADI : 206-806 LED GÖSTERGELİ VOLT M.
FİYAT : 102,00 EURO

- IP65 su ve tozdan koruma
- 6-1000 VAC/DC otomatik gösterim
- AC>100 V gerilimi temassız tespit
- 2 kutup (R-L) faz sırası testi ve faz gösterimi
- 2000 Ω a kadar ölçüm ve Buzzer test
- SCHUKO ve CEE prizler için tek el kullanımı
- LED Lamba özelliği ve otomatik arka plan ışığı
- 35V üzeri hayati gerilimlerde sesli uyarı
- Otomatik kapanma fonksiyonu
- CAT IV 1000 V, IEC/EN 61243-3
- TÜV/GS onaylı
- 5 YIL GARANTİ



KOD: : 999 094 310807
ÜRÜN ADI : 206-807 PROFİ LCD PLUS
FİYAT : 168,11 EURO

- LCD ekranlı
- IP65 su ve tozdan koruma
- 6-1000 VAC/DC otomatik gösterim
- AC>100 V gerilimi temassız tespit
- 2 kutup (R-L) faz sırası testi ve faz gösterimi
- 2000 Ω a kadar ölçüm ve Buzzer test
- SCHUKO ve CEE prizler için tek el kullanımı
- LED Lamba özelliği ve otomatik arka plan ışığı
- 35V üzeri hayati gerilimlerde sesli uyarı
- Otomatik kapanma fonksiyonu
- CAT IV 1000 V, IEC/EN 61243-3
- TÜV/GS onaylı
- 5 YIL GARANTİ



KOD: : 999 094 310804
ÜRÜN ADI : 206-804 TEST BOY
FİYAT : 49,12 EURO

- Elektrik olan kabloların, prizlerin, arızalı ampullerin tespiti için ideal
- 12-1000 VAC arası tespit
- IP44 ABS Plastik
- CAT III 1000V, IEC/EN 61010-1
- 45 gr ağırlıklı
- Sesli ve görsel uyarı
- LED fener özelliği
- 2xAAA pil ile çalışır
- 5 YIL GARANTİ

| Kod | Açıklama / Stok Cinsi | Amb. Kutu/Bağ | Amb. Koli/Cv | FİYAT |
|---|---|---------------|--------------|--------|
| GEÇMELİ SOKET KLEMENS | | | | |
| 999 999 991212 | 12'LI GEÇMELİ SOKET KLEMENS | 30 ad. | | 15,374 |
| METAL ÜZERİ BAKIR VE NİKEL KAPLAMALI SIRA KLEMENSLER | | | | |
| 015 094 153001 | NO. 1 NİKEL KAPLAMA SIRA KLEMENSLER SİYAH (2.5-4 MM2) | 50 ad. | 1000 | 1,637 |
| 015 094 153002 | NO. 2 NİKEL KAPLAMA SIRA KLEMENSLER SİYAH (4-6 MM2) | 50 ad. | 1000 | 1,994 |
| 015 094 153003 | NO. 3 NİKEL KAPLAMA SIRA KLEMENSLER SİYAH (6-10 MM2) | 50 ad. | 400 | 3,155 |
| 015 094 153004 | NO. 4 NİKEL KAPLAMA SIRA KLEMENSLER SİYAH (10-16 MM2) | 50 ad. | 400 | 3,512 |
| YANMAZ (v2) METAL ÜZERİ BAKIR VE NİKEL KAPLAMALI SIRA KLEMENSLER | | | | |
| 015 094 173001 | NO. 1 YANMAZ (v2) NİKEL KAPLAMA KLEMENSLER ŞEFFAF (2.5-4 MM2) | 50 ad. | 1000 | 1,786 |
| 015 094 173002 | NO. 2 YANMAZ (v2) NİKEL KAPLAMA KLEMENSLER ŞEFFAF (4-6 MM2) | 50 ad. | 1000 | 2,143 |
| 015 094 173003 | NO. 3 YANMAZ (v2) NİKEL KAPLAMA KLEMENSLER ŞEFFAF (6-10 MM2) | 50 ad. | 400 | 3,274 |
| 015 094 173004 | NO. 4 YANMAZ (v2) NİKEL KAPLAMA KLEMENSLER ŞEFFAF (10-16 MM2) | 50 ad. | 400 | 4,227 |
| ALEV ALMAZ (v0) METAL ÜZERİ BAKIR VE NİKEL KAPLAMALI SIRA KLEMENSLER | | | | |
| 015 094 174001 | NO. 1 ALEV ALMAZ (v0) NİKEL KAPLAMA KLEMENSLER KAHVERENGİ (2.5-4 MM2) | 50 ad. | 1000 | 1,994 |
| 015 094 174002 | NO. 2 ALEV ALMAZ (v0) NİKEL KAPLAMA KLEMENSLER KAHVERENGİ (4-6 MM2) | 50 ad. | 1000 | 2,470 |
| 015 094 174003 | NO. 3 ALEV ALMAZ (v0) NİKEL KAPLAMA KLEMENSLER KAHVERENGİ (6-10 MM2) | 50 ad. | 400 | 3,750 |
| 015 094 174004 | NO. 4 ALEV ALMAZ (v0) NİKEL KAPLAMA KLEMENSLER KAHVERENGİ (10-16 MM2) | 50 ad. | 400 | 4,614 |
| EKO SERİSİ PLASTİK SIRA KLEMENSLER | | | | |
| 015 094 151001 | NO. 1 SIRA KLEMENSLER (EKO) (2.5-4 MM2) | 50 ad. | 1000 | 1,906 |
| 015 094 151002 | NO. 2 SIRA KLEMENSLER (EKO) (4-6 MM2) | 50 ad. | 800 | 2,336 |
| 015 094 151003 | NO. 3 SIRA KLEMENSLER (EKO) (6-10 MM2) | 50 ad. | 500 | 2,541 |
| 015 094 151004 | NO. 4 SIRA KLEMENSLER (EKO) (10-16 MM2) | 50 ad. | 500 | 3,240 |
| 015 094 151005 | NO. 5 SIRA KLEMENSLER (EKO) (16-25 MM2) | 50 ad. | 500 | 3,844 |
| EKO SERİSİ ISIYA DAYANIKLI PLASTİK SIRA KLEMENSLER | | | | |
| 015 094 171001 | NO. 1 ISIYA DAYANIKLI KLEMENSLER (EKO) (2.5-4 MM2) | 50 ad. | 1000 | 2,256 |
| 015 094 171002 | NO. 2 ISIYA DAYANIKLI KLEMENSLER (EKO) (4-6 MM2) | 50 ad. | 800 | 2,772 |
| 015 094 171003 | NO. 3 ISIYA DAYANIKLI KLEMENSLER (EKO) (6-10 MM2) | 50 ad. | 500 | 2,912 |
| 015 094 171004 | NO. 4 ISIYA DAYANIKLI KLEMENSLER (EKO) (10-16 MM2) | 50 ad. | 500 | 3,529 |
| 015 094 171005 | NO. 5 ISIYA DAYANIKLI KLEMENSLER (EKO) (16-25 MM2) | 50 ad. | 500 | 4,440 |
| PLASTİK SIRA KLEMENSLER | | | | |
| 015 094 150001 | NO. 1 SIRA KLEMENSLER (2.5-4 MM2) | 50 ad. | 1000 | 2,468 |
| 015 094 150002 | NO. 2 SIRA KLEMENSLER (4-6 MM2) | 50 ad. | 800 | 2,922 |
| 015 094 150003 | NO. 3 SIRA KLEMENSLER (6-10 MM2) | 50 ad. | 500 | 4,026 |
| 015 094 150004 | NO. 4 SIRA KLEMENSLER (10-16 MM2) | 50 ad. | 500 | 4,254 |
| 015 094 150005 | NO. 5 SIRA KLEMENSLER (16-25 MM2) | 50 ad. | 500 | 5,466 |
| ISIYA DAYANIKLI SIRA KLEMENSLER | | | | |
| 015 094 170001 | NO. 1 ISIYA DAYANIKLI KLEMENSLER (2.5-4 MM2) | 50 ad. | 1000 | 2,695 |
| 015 094 170002 | NO. 2 ISIYA DAYANIKLI KLEMENSLER (4-6 MM2) | 50 ad. | 800 | 3,280 |
| 015 094 170003 | NO. 3 ISIYA DAYANIKLI KLEMENSLER (6-10 MM2) | 50 ad. | 500 | 4,611 |
| 015 094 170004 | NO. 4 ISIYA DAYANIKLI KLEMENSLER (10-16 MM2) | 50 ad. | 500 | 4,936 |
| 015 094 170005 | NO. 5 ISIYA DAYANIKLI KLEMENSLER (16-25 MM2) | 50 ad. | 500 | 5,975 |
| PORSELEN KLEMENSLER | | | | |
| 015 094 180002 | NO. 1-2'Lİ PORSELEN KLEMENS | 300 ad. | | 0,929 |
| 015 094 180003 | NO. 1-3'LÜ PORSELEN KLEMENS | 220 ad. | | 1,326 |
| 015 094 180004 | NO. 2-2'Lİ PORSELEN KLEMENS | 200 ad. | | 1,366 |
| 015 094 180005 | NO. 2-3'LÜ PORSELEN KLEMENS | 177 ad. | | 1,752 |
| 015 094 180006 | NO. 3-2'Lİ PORSELEN KLEMENS | 104 ad. | | 1,793 |
| 015 094 180007 | NO. 3-3'Lİ PORSELEN KLEMENS | 64 ad. | | 2,458 |
| U KLEMENSLER | | | | |
| 014 094 030006 | 6'LİK U KLEMENSİ | 300 ad. | | 1,572 |
| 014 094 030010 | 10'LUK U KLEMENSİ | 250 ad. | | 2,108 |
| 014 094 030016 | 16'LİK U KLEMENSİ | 100 ad. | | 3,031 |
| 014 094 030025 | 25'LİK U KLEMENSİ | 100 ad. | | 3,525 |
| 014 094 030035 | 35'LİK U KLEMENSİ | 75 ad. | | 4,282 |
| 014 094 030050 | 50'LİK U KLEMENSİ | 50 ad. | | 6,588 |
| 014 094 030070 | 70'LİK U KLEMENSİ | 40 ad. | | 7,511 |
| 014 094 030095 | 95'LİK U KLEMENSİ | 25 ad. | | 11,266 |
| 014 094 030120 | 120'LİK U KLEMENSİ | 20 ad. | | 13,407 |
| 014 094 030150 | 150'LİK U KLEMENSİ | 15 ad. | | 18,941 |
| ŞEFFAF ISIYA DAYANIKLI BUAT KLEMESLER | | | | |
| 888 094 000105 | NO.2 ŞEFFAF BUAT KLEMENS (1 ADET FİYAT) | 560 ad. | | 0,432 |
| 888 094 000205 | NO.3 ŞEFFAF BUAT KLEMENS (1 ADET FİYAT) | 420 ad. | | 0,595 |
| 888 094 000405 | NO.4 ŞEFFAF BUAT KLEMENS (1 ADET FİYAT) | 300 ad. | | 1,042 |
| 888 094 000605 | NO.5 ŞEFFAF BUAT KLEMENS (1 ADET FİYAT) | 160 ad. | | 1,191 |
| MOTOR KLEMENSLER | | | | |
| 022 094 200001 | NO. 1 MOTOR KLEMENS | 50 ad. | | 3,096 |
| 022 094 200002 | NO. 2 MOTOR KLEMENS | 50 ad. | | 3,603 |
| 022 094 200003 | NO. 3 MOTOR KLEMENS | 50 ad. | | 4,668 |
| 022 094 200004 | NO. 4 MOTOR KLEMENS | 40 ad. | | 6,791 |
| 022 094 200005 | NO. 5 MOTOR KLEMENS | 15 ad. | | 12,628 |
| 022 094 200006 | NO. 6 MOTOR KLEMENS | 6 ad. | | 22,334 |
| TIRNAKLI KLEMENSLER | | | | |
| 014 094 100001 | NO:1 TIRNAKLI KLEMENS 16MM | 500 ad. | | 2,834 |
| 014 094 100002 | NO:2 TIRNAKLI KLEMENS 25MM | 250 ad. | | 3,828 |
| 014 094 100003 | NO:3 TIRNAKLI KLEMENS 35MM | 100 ad. | | 4,917 |
| 014 094 100004 | NO:4 TIRNAKLI KLEMENS 50MM | 100 ad. | | 7,328 |
| 014 094 100005 | NO:5 TIRNAKLI KLEMENS 70MM | 100 ad. | | 8,746 |
| 014 094 100006 | NO:6-7 TIRNAKLI KLEMENS 95MM | 50 ad. | | 17,263 |

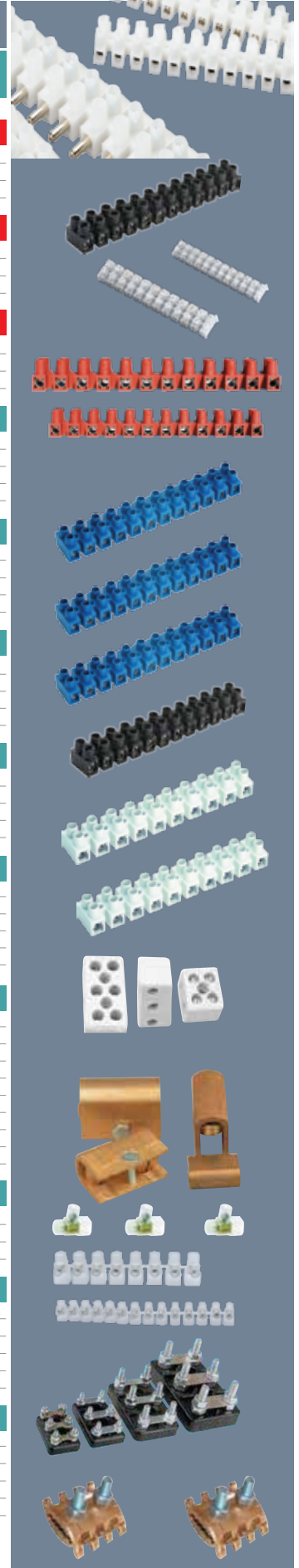



| Kod | Açıklama / Stok Cinsi | Amb. (Kutu/Bag) | Amb. (Koli/Çv.) | FİYAT |
|---|--|--------------------|--------------------|-----------|
| 125 A. 1 KUTUPLU DAĞITIM ÜNİTESİ (7X12 MM) | | | | |
| 014 102 112507 | 125 A. 1 KUTUP DAĞITIM ÜNİTESİ 7 DELİKLİ | | 65 | 6,876 |
| 014 102 112510 | 125 A. 1 KUTUP DAĞITIM ÜNİTESİ 10 DELİKLİ | | 48 | 8,304 |
| 014 102 112512 | 125 A. 1 KUTUP DAĞITIM ÜNİTESİ 12 DELİKLİ | | 40 | 9,822 |
| 014 102 112515 | 125 A. 1 KUTUP DAĞITIM ÜNİTESİ 15 DELİKLİ | | 36 | 11,608 |
| 014 102 112520 | 125 A. 1 KUTUP DAĞITIM ÜNİTESİ 20 DELİKLİ | | 30 | 15,716 |
| 125 A. 2 KUTUPLU DAĞITIM ÜNİTESİ (7X12 MM) | | | | |
| 014 102 212507 | 125 A. 2 KUTUP DAĞITIM ÜNİTESİ 7 DELİKLİ | | 22 | 16,073 |
| 014 102 212510 | 125 A. 2 KUTUP DAĞITIM ÜNİTESİ 10 DELİKLİ | | 15 | 17,859 |
| 014 102 212512 | 125 A. 2 KUTUP DAĞITIM ÜNİTESİ 12 DELİKLİ | | 14 | 19,645 |
| 014 102 212515 | 125 A. 2 KUTUP DAĞITIM ÜNİTESİ 15 DELİKLİ | | 12 | 25,895 |
| 014 102 212520 | 125 A. 2 KUTUP DAĞITIM ÜNİTESİ 20 DELİKLİ | | 6 | 32,503 |
| 125 A. 4 KUTUPLU DAĞITIM ÜNİTESİ (7X12 MM) | | | | |
| 014 102 412507 | 125 A. 4 KUTUP DAĞITIM ÜNİTESİ 7 DELİKLİ | | 10 | 37,503 |
| 014 102 412510 | 125 A. 4 KUTUP DAĞITIM ÜNİTESİ 10 DELİKLİ | | 8 | 39,289 |
| 014 102 412512 | 125 A. 4 KUTUP DAĞITIM ÜNİTESİ 12 DELİKLİ | | 6 | 42,861 |
| 014 102 412515 | 125 A. 4 KUTUP DAĞITIM ÜNİTESİ 15 DELİKLİ | | 5 | 50,897 |
| 014 102 412520 | 125 A. 4 KUTUP DAĞITIM ÜNİTESİ 20 DELİKLİ | | 4 | 64,827 |
| 014 102 412522 | 125 A. 4 KUTUP DAĞITIM ÜNİTESİ 22 DELİKLİ | | 4 | 68,756 |
| 014 102 412525 | 125 A. 4 KUTUP DAĞITIM ÜNİTESİ 25 DELİKLİ | | 4 | 80,364 |
| KAPI VE MERDİVEN OTOMATIĞI | | | | |
| 027 112 000001 | GİZLİ KAPI OTOMATIĞI (DOKUNMATİK) | 1 ad. | 20 | 53,504 |
| 027 112 000002 | GİZLİ KAPI OTOMATIĞI (BASMATİK) | 1 ad. | 20 | 53,504 |
| 027 112 000007 | ELEK. KİLİTLİ (ANAHTARLI) KAPI OTOMATIĞI | 1 ad. | 12 | 94,778 |
| 027 112 000009 | ELEKTRİKLİ KİLİTLİ KAPI OTOMATIĞI (BİLYELİ) | 1 ad. | 12 | 92,271 |
| 027 112 000003 | BUTONLU KAPI OTOMATIĞI | 1 ad. | 30 | 36,688 |
| 028 112 000004 | KAPI OTOMATIĞI (NORMAL) | 1 ad. | 30 | 35,160 |
| 027 112 000005 | MERDİVEN OTOMATIĞI (RAYLI) | 1 ad. | 30 | 29,045 |
| 027 112 000006 | MERDİVEN OTOMATIĞI (NORMAL) | 1 ad. | 30 | 29,045 |
| ZİL BUTONU ÇEŞİTLERİ | | | | |
| 037 106 020001 | 1'Lİ ALÜMİNYUM ZİL BUTONU 1.KALİTE | 1 ad. | | 4,127 |
| 037 106 020002 | 2'Lİ ALÜMİNYUM ZİL BUTONU 1.KALİTE | 1 ad. | | 8,255 |
| 037 106 020003 | 3'LÜ ALÜMİNYUM ZİL BUTONU 1.KALİTE | 1 ad. | | 12,382 |
| 037 106 020004 | 4'LÜ ALÜMİNYUM ZİL BUTONU 1.KALİTE | 1 ad. | | 16,510 |
| 037 106 020005 | 5'Lİ ALÜMİNYUM ZİL BUTONU 1.KALİTE | 1 ad. | | 20,637 |
| 037 106 020006 | 6'Lİ ALÜMİNYUM ZİL BUTONU 1.KALİTE | 1 ad. | | 24,765 |
| 037 106 020007 | 7'Lİ ALÜMİNYUM ZİL BUTONU 1.KALİTE | 1 ad. | | 28,892 |
| 037 106 020008 | 8'Lİ ALÜMİNYUM ZİL BUTONU 1.KALİTE | 1 ad. | | 33,019 |
| 037 106 020009 | 9'LÜ ALÜMİNYUM ZİL BUTONU 1.KALİTE | 1 ad. | | 37,147 |
| 037 106 020010 | 10'LÜ ALÜMİNYUM ZİL BUTONU 1.KALİTE | 1 ad. | | 41,274 |
| MUTLUSAN UZAKTAN KUMANDALI ZİL ve KAPI PENCERE ALARMLARI | | | | |
| 888 038 218000 | Q218 KABLOSUZ KAPI ZİLİ LEDLİ 100 MT. 32MELODİ | 1 ad. | 10 | 15,847 \$ |
| 888 038 007000 | 007-D KAPI/PENCERE ALARMI 2 SESLİ | 1 ad. | 10 | 5,117 \$ |
| 889 038 008000 | 008-C LEDLİ İNFAZ.PIR.SEN.ALARM/KAPI ZİL 32M.8MT | 1 ad. | 10 | 17,304 \$ |
| ZİLLER VE ZİL TRAFOLARI | | | | |
| 027 105 010012 | ZİL TRAFOSU 12 V | 1 ad. | 80 | 13,394 |
| 027 105 010015 | ZİL TRAFOSU 15 V | 1 ad. | 30 | 23,812 |
| 028 105 020003 | KAMPANA ZİL 220 V | 1 ad. | 24 | 44,647 |
| 028 105 020004 | KAMPANA ZİL 12V, 24V, 110V | 1 ad. | 24 | 53,576 |
| 028 105 020000 | MUNZAM ZİL ROLESİ | 1 ad. | 100 | 29,764 |
| 018 105 000006 | KANARYA ZİL (TEK SES) | 1 ad. | 50 | 9,376 |
| 018 105 000007 | KANARYA ZİL (UÇ SES) | 1 ad. | 50 | 9,673 |
| 018 105 000001 | TELEFON ZİLİ (AYARLI) | 1 ad. | 50 | 11,162 |
| 018 105 000002 | DİNG DONG ZİL ELEKTRONİK (3 SES) | 1 ad. | 50 | 12,501 |
| 018 105 000003 | MEKANİK DİNG DONG ZİL | 1 ad. | 20 | 44,647 |
| 018 105 000004 | KONUŞAN ZİL 120 MELODİ | 1 ad. | 30 | 17,859 |
| DIYAFON MERKEZİ VE ŞUBELERİ | | | | |
| 018 104 000001 | DIYAFON MERKEZİ 1"LI | 1 ad. | | 89,293 |
| 018 104 000002 | DIYAFON MERKEZİ 2"LI | 1 ad. | | 93,758 |
| 018 104 000003 | DIYAFON MERKEZİ 3"LU | 1 ad. | | 98,223 |
| 018 104 000004 | DIYAFON MERKEZİ 4"LU | 1 ad. | | 102,687 |
| 018 104 000005 | DIYAFON MERKEZİ 5"LI | 1 ad. | | 107,152 |
| 018 104 000099 | DIYAFON ŞUBESİ | 1 ad. | | 9,673 |
| İTHAL ÜRÜNLERİMİZ | | | | |
| 999 999 000081 | 9V PİLLİ DUMAN DEDEKTÖRÜ | 1 ad. | | 14,824 \$ |
| 999 999 000080 | KABLOLU GAZ DEDEKTÖRÜ | 1 ad. | | 13,372 |
| 888 038 250027 | 360 DERECE PIR HAREKET SENSÖRÜ | 1 ad. | | 16,153 \$ |
| 999 133 011019 | ERİYEN BANT | 1 ad. | | 2,446 \$ |
| 065 133 001019 | 10X19 İZOLE BANT | 1 ad. | | 0,599 \$ |
| 065 133 020000 | ÇİFT TARAFLI BANT 1mm 20mm*50mt | 50 ad. | | 6,406 € |
| 065 133 020003 | ÇİFT TARAFLI BANT 1mm 25mm*50mt | 50 mt. | | 8,007 € |
| 065 133 020001 | ÇİFT TARAFLI BANT 1mm 30mm*50mt | 50 mt. | | 9,609 € |

YANGIN ALGILAMA SİSTEMLERİ



| Kod | Açıklama / Stok Cinsi | Amb. (Kutu/Bag) | Amb. (Kali/Çel.) | TL |
|---|---|--------------------|---------------------|-----------|
| DÖNER LAMBA FLAŞÖR SİREN REFKONTAK | | | | |
| 001 111 020004 00 00 | DÖNER LAMBA 220 V AC | 1 ad. | | 55,808 |
| 001 111 020001 00 00 | DÖNER LAMBA 12 V AC | 1 ad. | | 62,505 |
| 001 111 020002 00 00 | DÖNER LAMBA 24 V AC | 1 ad. | | 62,505 |
| 001 111 030003 00 00 | FLAŞÖRLÜ İKAZ LAMBASI 220 V | 1 ad. | | 43,158 |
| 026 111 020005 | 12 V.DC.MIKNATISLI DÖNER LAMBA(OTO TIPI) | 1 ad. | | 133,940 |
| 102 111 000012 | LEDLİ FLAŞÖRLÜ ELEKTRONİK SİREN 12V | 1 ad. | | 44,647 |
| 102 111 000024 | LEDLİ FLAŞÖRLÜ ELEKTRONİK SİREN 24V | 1 ad. | | 44,647 |
| 102 111 000220 | LEDLİ FLAŞÖRLÜ ELEKTRONİK SİREN 220V | 1 ad. | | 49,111 |
| 026 111 000001 | UÇAK İKAZ LAMBASI (AMPULLÜ) | 1 ad. | | 145,846 |
| 026 111 000002 | UÇAK İKAZ LAMBA SEHPASI | 1 ad. | | 104,363 |
| 888 111 050004 | MS190 MİNİ SİREN (105 db.) | 1 ad. | | 18,040 \$ |
| 001 999 050005 00 00 | MS290P PLASTİK SİREN 220V (80 db.) | 1 ad. | | 21,389 |
| 026 111 010001 | AS. 1 MOTORLU SİREN (PLS. GÖV.)220V,150W (110 db.) | 1 ad. | | 89,293 |
| 026 111 010002 | AS. 2 MOTORLU SİREN (PLS.GÖV.)220V,200W (115 db.) | 1 ad. | | 133,940 |
| 026 111 010003 | AS. 1 MOTORLU SİREN (METAL.GÖV.)220V,150W (112 db.) | 1 ad. | | 148,822 |
| 026 111 010004 | AS. 2 MOTORLU SİREN (METAL.GÖV.)220V,200W (117 db.) | 1 ad. | | 178,586 |
| 026 111 010005 | AS.3 MOTORLU SİREN 220V-280W (150 db.) | 1 ad. | | 1.011,990 |
| 026 111 010008 | AS.4 MOTORLU SİREN 220V-500W (160 db.) | 1 ad. | | 1.384,045 |
| 026 111 010009 | AS.5 MOTORLU SİREN 220V-750W (180 db.) | 1 ad. | | 5.804,060 |
| ALARM KORNA VE YANGIN İHBAR BUTONU | | | | |
| 010 090 050050 | RESETELEBİLİR BUTON | 1 ad. | | 41,671 |
| 010 090 050051 | RESETELEBİLİR BUTON (KAPAKLI) | 1 ad. | | 47,624 |
| 028 120 010006 | ALARM KORNA PLASTİK | 1 ad. | | 44,647 |
| 028 120 010005 | ALARM KORNA DÖKÜM | 1 ad. | | 47,624 |





| Kod | Açıklama / Stok Cinsi | Amb. (Kutu/Bag) | Amb. (Kolu/Çv.) | FİYAT |
|---|--|--------------------|--------------------|-------------|
| YANGIN İHBAR KONTROL PANELLERİ STANDART | | | | |
| 006 086 601004 | EFIRE ECP-1004 4 ZONLU KONTROL PANELİ | 1 ad. | | 220,000\$ |
| 006 086 601008 | EFIRE ECP-1008 8 ZONLU KONTROL PANELİ | 1 ad. | | 240,000\$ |
| 006 086 601012 | EFIRE ECP-1012 12 ZONLU KONTROL PANELİ | 1 ad. | | 270,000\$ |
| 006 086 601016 | EFIRE ECP-1016 16 ZONLU KONTROL PANELİ | 1 ad. | | 320,000\$ |
| YANGIN İHBAR KONTROL TEKRARLAMA PANELLERİ | | | | |
| 006 086 001005 | EFIRE ECP-RP 4 ZONLU TEKRARLAMA PANELİ | 1 ad. | | 180,000\$ |
| 006 086 001007 | EFIRE ECP-RP 8 ZONLU TEKRARLAMA PANELİ | 1 ad. | | 195,000\$ |
| 006 086 001012 | EFIRE ECP-RP 12 ZONLU TEKRARLAMA PANELİ | 1 ad. | | 210,000\$ |
| 006 086 001017 | EFIRE ECP-RP 16 ZONLU TEKRARLAMA PANELİ | 1 ad. | | 300,000\$ |
| 006 086 200015 | E-NW-485 TEKRARLAMA PANEL NETWORK KARTI | 1 ad. | | 75,000\$ |
| KURU VE SIZDIRMAZ TİP BAKIM GEREKTİRMİYEN AKÜLER | | | | |
| 006 086 101220 | BAT-1220 12V / 2AH. KURU TİP AKÜ | 1 ad. | | 29,000\$ |
| 006 086 101270 | BAT-1270 12V / 7AH. KURU TİP AKÜ | 1 ad. | | 35,000\$ |
| YANGIN İHBAR DEDEKTÖRLERİ | | | | |
| 006 086 200001 | EFIRE EOD OPTİK DUMAN DEDEKTÖRÜ | 1 ad. | | 19,000\$ |
| 006 086 200005 | EFIRE EHD-58 SABİT SICAKLIK DEDEKTÖRÜ-58 C | 1 ad. | | 14,000\$ |
| 006 086 200006 | EFIRE EHD-82 SABİT SICAKLIK DEDEKTÖRÜ-82 C | 1 ad. | | 14,000\$ |
| 006 086 200002 | EFIRE ERD SICAKLIK ARTIŞ HIZI DEDEKTÖRÜ | 1 ad. | | 14,000\$ |
| 006 086 326225 | EFIRE ECD KOMBİNE (DUMAN+HSI) DEDEKTÖRÜ | 1 ad. | | 26,000\$ |
| 006 086 200003 | EFIRE EDB STANDART DEDEKTÖR SÖKETİ | 1 ad. | | 3,000\$ |
| YANGIN İHBAR BUTON, SİRENLERİ VE AKSESUARLARI | | | | |
| 006 086 300001 | EFIRE EYIB YNG.İHB. BUT. VE KASASI 12-24V | 1 ad. | | 12,000\$ |
| 006 086 401224 | AS-1224 ELEKTRONİK SİREN | 1 ad. | | 13,000\$ |
| 006 086 500009 | AS-1224-LED FLAŞÖRLÜ ELEKTRONİK SİREN | 1 ad. | | 25,000\$ |
| 006 086 700009 | E-PIL-PARALEL İHBAR LAMBASI | 1 ad. | | 12,000\$ |
| 999 999 777149 | EGD 200-220-LPG GAZ DEDEKTÖRÜ 220V | 1 ad. | | 30,000\$ |
| 999 999 777164 | EGD 200-24-LPG GAZ DEDEKTÖRÜ 12-24V | 1 ad. | | 30,000\$ |
| 006 086 400220 | AS220-ELEKTRONİK SİREN 220V | 1 ad. | | 15,000\$ |
| 006 086 500010 | AS220-LED ELEKTRONİK SİREN 220V | 1 ad. | | 27,000\$ |
| 006 125 100110 | EFIRE EYIB NO/NC-YANGIN İHBAR BUTONU NO/NC ÇIKIŞLI 220V | 1 ad. | | 14,000\$ |
| ÖZEL AMAÇLI ÜRÜNLER | | | | |
| 006 086 700010 | DLFB-R-IŞIN TİPİ BEAM DEDEKTÖR 3-100 MT / SD3 | 1 ad. | | 810,000€ |
| 006 086 700011 | DLFB30-R-IŞIN TİPİ BEAM DEDEKTÖR 30MT / SD3 | 1 ad. | | 660,000€ |
| 885 325 000138 | NB-138-12VDC-SU BASKIN DEDEKTÖRÜ RÖLE ÇIKIŞI / WIZMART | 1 ad. | | 24,000\$ |
| 885 325 000606 | NB-606-4-SIGARA DUMANI ALGILAMA DEDEKTÖRÜ 24V / WIZMART | 1 ad. | | 55,000\$ |
| 885 326 002000 | FS2000E-DAHİLİ ORTAM ALEV DEDEKTÖRÜ / PULNIX | 1 ad. | | 445,000\$ |
| 885 326 005000 | FS5000E-HARİCİ ORTAM ALEV DEDEKTÖRÜ / PULNIX | 1 ad. | | 860,000\$ |
| 999 999 000581 | NFE-MEKANİK DEPREM SENSÖRÜ | 1 ad. | | 500,000\$ |
| 999 999 001191 | SISCUT ELEKTRONİK DEPREM SENSÖRÜ | 1 ad. | | 230,000\$ |
| ADRESLİ YANGIN İHBAR PANELLERİ VE AKSESUARLARI | | | | |
| 006 086 510240 | SAYA 1 LOOP ADRESLİ PANEL 240 ADRES | 1 ad. | | 950,000€ |
| 006 086 530720 | SAYA 3 LOOP ADRESLİ PANEL 720 ADRES | 1 ad. | | 1.650,000€ |
| 006 086 210001 | V2100-1 LOOP ADRESLİ PANEL 240 ADRES / VELOX | 1 ad. | | 1.625,000\$ |
| 006 086 220002 | V2200-2 LOOP ADRESLİ PANEL 480 ADRES / VELOX | 1 ad. | | 2.625,000\$ |
| 006 086 440033 | 4400-3L-3 LOOP ADRESLİ PANEL-720 ADRES / VELOX | 1 ad. | | 5.658,000\$ |
| 006 086 004020 | 4020-TEKRARLAMA PANELİ 4000 SERİ PANELLER İÇİN / VELOX | 1 ad. | | 2.080,000\$ |
| 006 086 004420 | 4420-RS 485 PANELLER NETWORK KARTI / VELOX | 1 ad. | | 550,000\$ |
| 006 086 500001 | S-485 SAYA PANELLER İÇİN NETWORK KARTI | 1 ad. | | 400,000€ |
| 006 086 511000 | SAYA-RP SAYA TEKRARLAMA PANELİ | 1 ad. | | 685,000€ |
| ADRESLİ YANGIN İHBAR DEDEKTÖRLERİ | | | | |
| 888 888 000100 | LV100-ADRESLİ DUMAN DEDEKTÖRÜ / VELOX | 1 ad. | | 39,130\$ |
| 888 888 000350 | LV350-ADRESLİ İSİ DEDEKTÖRÜ / VELOX | 1 ad. | | 39,130\$ |
| 888 888 000200 | LV200-ADRESLİ KOMBİNE DEDEKTÖRÜ / VELOX | 1 ad. | | 44,500\$ |
| 888 888 040900 | 40900-ADRESLİ DEDEKTÖR SÖKETİ / VELOX | 1 ad. | | 4,000\$ |
| YANGIN İHBAR BUTON, SİRENLERİ VE MODÜLLER | | | | |
| 888 888 040800 | 40800-ADRESLİ YANGIN İHBAR BUTONU / VELOX | 1 ad. | | 48,000\$ |
| 888 888 040300 | 40300-ADRESLİ SİREN / VELOX | 1 ad. | | 90,870\$ |
| 888 888 040002 | 40002-2 Lİ ÇIKIŞ RÖLE MODÜLÜ / VELOX | 1 ad. | | 61,000\$ |
| 888 888 040010 | 40010-SİREN KONTROL MODÜLÜ (HARİCEN BESLENİR) / VELOX | 1 ad. | | 74,000\$ |
| 888 888 040100 | 40100-TEKLI GİRİŞ İZLEME MODÜLÜ / VELOX | 1 ad. | | 53,000\$ |
| 888 888 040102 | 40102-TEKLI GİRİŞ (İZLEME) 2'Lİ ÇIKIŞ RÖLE MODÜLÜ / VELOX | 1 ad. | | 88,000\$ |
| 888 888 040110 | 40110-TEKLI GİRİŞ (İZLEME) VE SİREN KONTROL MODÜLÜ / VELOX | 1 ad. | | 85,000\$ |
| 888 888 040500 | 40500-KONVANSİYONEL ZON MODÜLÜ / VELOX | 1 ad. | | 173,000\$ |



| Kod | Açıklama / Stok Cinsi | Amb. (Kutu/Bag) | Amb. (Kali/Çul) | FİYAT |
|---|--|--------------------|--------------------|-------------|
| MAXLOGIC SERİSİ KONVANSİYONEL YANGIN ALARM SANTRALLERİ | | | | |
| 006 090 022102 | ML-22102 KONVANSİYONEL YANGIN ALARM SANTRALI, 2 BÖLGE | | | 475,000\$ |
| 006 090 022104 | ML-22104 KONVANSİYONEL YANGIN ALARM SANTRALI, 4 BÖLGE | | | 500,000\$ |
| 006 090 022108 | ML-22108 KONVANSİYONEL YANGIN ALARM SANTRALI, 8 BÖLGE | | | 600,000\$ |
| 006 090 022116 | ML-22116 KONVANSİYONEL YANGIN ALARM SANTRALI, 16 BÖLGE | | | 700,000\$ |
| MAXLOGIC KONVANSİYONEL STANDART YANGIN ALGILAMA DEDEKTÖRLERİ | | | | |
| 006 090 002110 | ML-2110 OPTİK DUMAN DEDEKTÖRÜ | | | 28,000\$ |
| 006 090 002120 | ML-2120 KOMBİNE SICAKLIK DEDEKTÖRÜ | | | 24,000\$ |
| 006 090 002130 | ML-2130 SABİT SICAKLIK DEDEKTÖRÜ | | | 24,000\$ |
| 006 090 002140 | ML-2140 MULTİSENSÖR DEDEKTÖRÜ | | | 42,000\$ |
| 006 090 003510 | ML-0140 DEDEKTÖR SOKETİ | | | 5,000\$ |
| MAVİGARD KONVANSİYONEL RÖLE ÇIKIŞLI YANGIN ALGILAMA DEDEKTÖRLERİ | | | | |
| 006 090 002100 | MGR-2100 OPTİK DUMAN DEDEKTÖRÜ, RÖLE ÇIKIŞLI, 12V DC | | | 28,000\$ |
| 006 090 002500 | MGR-2500 MULTİSENSÖR DEDEKTÖR (OPTİK DUMAN+SICAKLIK), RÖLE ÇIKIŞLI, 12V DC | | | 42,000\$ |
| 006 090 003550 | MG-3550 DEDEKTÖR SOKETİ (MGR SERİSİ İÇİN) | | | 5,000\$ |
| MAXLOGIC KONVANSİYONEL İŞİN (BEAM) TİPİ DUMAN DEDEKTÖRLERİ | | | | |
| 006 090 002170 | ML-2170 İŞİN (BEAM) TİPİ DUMAN DEDEKTÖRÜ (ALICI-VERİCİ DAHİL) | | | 1.350,000\$ |
| 006 090 002171 | ML-2171 İŞİN (BEAM) TİPİ DUMAN DEDEKTÖRÜ ALICISI | | | 900,000\$ |
| 006 090 002172 | ML-2172 İŞİN (BEAM) TİPİ DUMAN DEDEKTÖRÜ VERİCİSİ | | | 450,000\$ |
| 006 090 002173 | ML-2173 REFLEKTÖRLÜ İŞİN (BEAM) TİPİ DUMAN DEDEK. (ALICI-VERİCİ-REFLEKTÖR DAHİL) | | | 1.300,000\$ |
| 006 090 002174 | ML-2174 REFLEKTÖRLÜ İŞİN (BEAM) TİPİ DUMAN DEDEKTÖRÜ, ALICI-VERİCİ ÜNİTESİ | | | 1.225,000\$ |
| 006 090 000171 | ML-0171 İŞİN (BEAM) TİPİ DUMAN DEDEKTÖRÜ REFLEKTÖRÜ, 1'Lİ | | | 75,000\$ |
| 006 090 000174 | ML-0174 İŞİN (BEAM) TİPİ DUMAN DEDEKTÖRÜ REFLEKTÖRÜ, 4'LÜ | | | 300,000\$ |
| MAXLOGIC ELEKTRONİK SİREN, FLAŞÖRLÜ SİREN VE AKSESUARLAR | | | | |
| 006 090 002410 | ELEKTRONİK SİREN, KIRMIZI 24V DC | | | 35,000\$ |
| 006 090 002420 | ELEKTRONİK FLAŞÖR | | | 50,000\$ |
| 006 090 002430 | FLAŞÖRLÜ ELEKTRONİK SİREN, KIRMIZI 24V DC | | | 60,000\$ |
| 006 090 002710 | KONVANSİYONEL SİSTEM YANGIN ALARM BUTONU, RESETLENEBİLİR | | | 20,000\$ |
| MAVİGARD İKİ ALARM SEVİYESİ ÇIKIŞLI, ELEKTROKİMYASAL SENSÖRLÜ KONVANSİYONEL GAZ DEDEKTÖRLERİ | | | | |
| 006 090 002012 | GD2R-12EC KARBONMONOKSİT GAZ DEDEK. (CO), 12V DC, 2 ALR. SEV. ÇIKIŞLI, ELEKTROKİMYASAL | | | 150,000\$ |
| 006 090 002024 | GD2R-24EC KARBONMONOKSİT GAZ DEDEK. (CO), 24V DC, 2 ALR. SEV. ÇIKIŞLI, ELEKTROKİMYASAL | | | 150,000\$ |
| 006 090 002220 | GD2R-220EC KARBONMONOKSİT GAZ DEDEK. (CO), 230V AC, 2 ALR. SEV. ÇIKIŞLI, ELEKTROKİMYASAL | | | 150,000\$ |
| 006 090 000120 | ML-0120 SIVA ÜSTÜ BAĞLANTI KUTUSU | | | 12,000\$ |
| GD / GDR / TGDR SERİSİ KONVANSİYONEL GAZ DEDEKTÖRLERİ | | | | |
| 006 090 041224 | GDR-1224L LPG (BÜTAN+PROPAN) DEDEKTÖRÜ, 12/24V DC, RÖLE ÇIKIŞLI | | | 60,000\$ |
| 006 090 051224 | GDR-1224M METAN (DOĞALGAZ) DEDEKTÖRÜ, 12/24V DC, RÖLE ÇIKIŞLI | | | 60,000\$ |
| 006 090 040220 | GDR-220L LPG (BÜTAN+PROPAN) DEDEKTÖRÜ, 230V AC, RÖLE ÇIKIŞLI | | | 60,000\$ |
| 006 090 050220 | GDR-220M METAN (DOĞALGAZ) DEDEKTÖRÜ, 230V AC, RÖLE ÇIKIŞLI | | | 60,000\$ |
| 006 090 060220 | GD-220L LPG (BÜTAN+PROPAN) DEDEKTÖRÜ, 230V AC | | | 60,000\$ |
| 006 090 070220 | GD-220M METAN (DOĞALGAZ) DEDEKTÖRÜ, 230V AC | | | 60,000\$ |
| 006 090 080220 | GD-220EC KARBONMONOKSİT DEDEKTÖRÜ, 230V AC, ELEKTROKİMYASAL | | | 130,000\$ |
| 006 090 061224 | TGDR-1224M TAVAN TİPİ DOĞALGAZ (METAN) DEDEKTÖRÜ, 12/24V DC, RÖLELİ | | | 60,000\$ |
| 006 090 000120 | ML-0120 SIVA ÜSTÜ BAĞLANTI KUTUSU | | | 12,000\$ |
| MAXLOGIC SERİSİ AKILLI ADRESLİ YANGIN ALARM SANTRALLERİ, 8 ÇEVİRİME KADAR | | | | |
| 006 090 001230 | ML-1230 YANGIN ALARM SANTRALI, ÇEVİRİMSİZ | | | 1.250,000\$ |
| 006 090 001231 | ML-1231 YANGIN ALARM SANTRALI, 1 ÇEVİRİM, 127 ADRES | | | 1.750,000\$ |
| 006 090 001232 | ML-1232 YANGIN ALARM SANTRALI, 2 ÇEVİRİM, 254 ADRES | | | 2.500,000\$ |
| 006 090 001233 | ML-1233 YANGIN ALARM SANTRALI, 3 ÇEVİRİM, 381 ADRES | | | 3.250,000\$ |
| 006 090 001234 | ML-1234 YANGIN ALARM SANTRALI, 4 ÇEVİRİM, 508 ADRES | | | 4.000,000\$ |
| MAVİGARD / MAXLOGIC AKILLI ADRESLİ YANGIN ALGILAMA DEDEKTÖRLERİ | | | | |
| 006 090 009100 | MG-9100 OPTİK DUMAN DEDEKTÖRÜ | | | 60,000\$ |
| 006 090 009300 | MG-9300 İSİ DEDEKTÖRÜ | | | 60,000\$ |
| 006 090 009400 | MG-9400 MULTİSENSÖR DEDEKTÖRÜ (OPTİK DUMAN+İSİ) | | | 90,000\$ |
| 006 090 001110 | ML-1110 OPTİK DUMAN DEDEKTÖRÜ | | | 60,000\$ |
| 006 090 001130 | ML-1130 SICAKLIK DEDEKTÖRÜ | | | 60,000\$ |
| 006 090 001140 | ML-1140 MULTİSENSÖR DEDEKTÖRÜ | | | 90,000\$ |
| 006 090 051110 | ML-1110.SCI OPTİK DUMAN DEDEKTÖRÜ, KISA DEVRE İZOLATÖRLÜ | | | 80,000\$ |
| 006 090 051130 | ML-1130.SCI SICAKLIK DEDEKTÖRÜ, KISA DEVRE İZOLATÖRLÜ | | | 80,000\$ |
| 006 090 051140 | ML-1140.SCI MULTİSENSÖR DEDEKTÖRÜ, KISA DEVRE İZOLATÖRLÜ | | | 120,000\$ |
| 006 090 000140 | ML-0140 DEDEKTÖR SOKETİ | | | 5,000\$ |
| 006 090 003510 | MG-3510 DEDEKTÖR SOKETİ | | | 5,000\$ |
| MAXLOGIC AKILLI ADRESLİ YANGIN ALGILAMA VE ALARM SİSTEMLERİ İÇİN AKSESUARLAR | | | | |
| 006 090 001410 | ML-1410 ADRESLİ SİREN | | | 140,000\$ |
| 006 090 051410 | ML-1410.SCI ADRESLİ SİREN, KISA DEVRE İZOLATÖRLÜ | | | 160,000\$ |
| 006 090 001420 | ML-1420 ADRESLİ FLAŞÖR | | | 160,000\$ |
| 006 090 051420 | ML-1420.SCI ADRESLİ FLAŞÖR, KISA DEVRE İZOLATÖRLÜ | | | 180,000\$ |
| 006 090 001430 | ML-1430 ADRESLİ FLAŞÖRLÜ SİREN | | | 180,000\$ |
| 006 090 051430 | ML-1430.SCI ADRESLİ FLAŞÖRLÜ SİREN, KISA DEVRE İZOLATÖRLÜ | | | 200,000\$ |
| 006 090 001710 | ML-1710 ADRESLENEBİLİR YANGIN ALARM BUT., RESETLENEBİLİR, MONTAJ KASASI DAHİL | | | 70,000\$ |
| 006 090 051710 | ML-1710.SCI ADRESLENEBİLİR YANGIN ALR. BUT., KISA DEVRE İZOLATÖRLÜ, RESETLENEBİLİR | | | 100,000\$ |
| MAVİGARD AGD SERİSİ AKILLI ADRESLİ GAZ DEDEKTÖRLERİ | | | | |
| 006 090 011224 | AGD-1224L/VIP LPG (BÜTAN+PROPAN) DEDEKTÖRÜ, 12/24V DC | | | 135,000\$ |
| 006 090 021224 | AGD-1224M/VIP METAN (DOĞALGAZ) DEDEKTÖRÜ, 12/24V DC | | | 135,000\$ |
| 006 090 031224 | AGD-1224EC/VIP KARBONMONOKSİT DEDEKTÖRÜ, 24V DC, ELEKTROKİMYASAL | | | 200,000\$ |
| 006 090 010220 | AGD-220L/VIP LPG (BÜTAN+PROPAN) DEDEKTÖRÜ, 230V AC | | | 160,000\$ |
| 006 090 020220 | AGD-220M/VIP METAN (DOĞALGAZ) DEDEKTÖRÜ, 230V AC | | | 160,000\$ |
| 006 090 030220 | AGD-220EC/VIP KARBONMONOKSİT DEDEKTÖRÜ, 230V AC, ELEKTROKİMYASAL | | | 200,000\$ |
| 006 090 000120 | ML-0120 SIVA ÜSTÜ BAĞLANTI KUTUSU | | | 12,000\$ |
| MAXLOGIC AKILLI ADRESLİ İŞİN (BEAM) TİPİ DUMAN DEDEKTÖRLERİ | | | | |
| 006 090 001170 | ML-1170 İŞİN (BEAM) TİPİ DUMAN DEDEK. (ALICI-VERİCİ DAHİL) | | | 1.600,000\$ |
| 006 090 051170 | ML-1170.SCI İŞİN (BEAM) TİPİ DUMAN DEDEK. KISA DEVRE İZOLATÖRLÜ (ALICI-VERİCİ DAHİL) | | | 1.650,000\$ |
| 006 090 001171 | ML-1171 İŞİN (BEAM) TİPİ DUMAN DEDEK. ALICISI | | | 1.050,000\$ |
| 006 090 051171 | ML-1171.SCI İŞİN (BEAM) TİPİ DUMAN DEDEK. ALICISI, KISA DEVRE İZOLATÖRLÜ | | | 1.100,000\$ |
| 006 090 001172 | ML-1172 İŞİN (BEAM) TİPİ DUMAN DEDEK. VERİCİSİ | | | 550,000\$ |
| 006 090 001173 | ML-1173 REFLEKTÖRLÜ İŞİN (BEAM) TİPİ DUMAN DEDEK. (ALICI-VERİCİ-REFLEKTÖR DAHİL) | | | 1.550,000\$ |
| 006 090 051173 | ML-1173.SCI REFLEKTÖRLÜ İŞİN (BEAM) TİPİ DUMAN DEDEK. KISA DEVRE İZOLATÖRLÜ (ALICI-VERİCİ-REFL. DAHİL) | | | 1.600,000\$ |
| 006 090 001174 | ML-1174 REFLEKTÖRLÜ İŞİN (BEAM) TİPİ DUMAN DEDEK. ALICI-VERİCİ ÜNİTESİ | | | 1.475,000\$ |
| 006 090 051174 | ML-1174.SCI REFLEKTÖRLÜ İŞİN (BEAM) TİPİ DUMAN DEDEK. ALICI-VERİCİ ÜNİTESİ, KISA DEVRE İZOLATÖRLÜ | | | 1.525,000\$ |
| 006 090 000171 | ML-0171 İŞİN (BEAM) TİPİ DUMAN DEDEKTÖRÜ REFLEK. 1'Lİ | | | 75,000\$ |
| 006 090 000174 | ML-0174 İŞİN (BEAM) TİPİ DUMAN DEDEKTÖRÜ REFLEKTÖRÜ, 4'LÜ | | | 300,000\$ |



| Kod | Açıklama / Stok Cinsi | Amb. (Kutu/Bag) | Amb. (Kali/Çvli) | FİYAT |
|-----|-----------------------|--------------------|---------------------|-------|
|-----|-----------------------|--------------------|---------------------|-------|

MUTLUSAN ASPİRATÖR ÇEŞİTLERİ

| | | | | |
|----------------------|------------------------|-------|----|--------|
| 001 111 000100 00 00 | MUTLUSAN 100 ASPİRATÖR | 1 ad. | 20 | 26,139 |
| 001 111 000120 00 00 | MUTLUSAN 120 ASPİRATÖR | 1 ad. | 20 | 29,406 |
| 001 111 000150 00 00 | MUTLUSAN 150 ASPİRATÖR | 1 ad. | 20 | 35,688 |
| 001 111 000200 00 00 | MUTLUSAN 200 ASPİRATÖR | 1 ad. | 20 | 59,381 |











AIRCOL ASPİRATÖR ÇEŞİTLERİ

| | | |
|---|--|---|
|  <p>ÜRÜN KODU 029 088 110100 ÜRÜN ADI AIRCOL 100 ASPİRATÖR AMBALAJ ADET / KOLİ 1 ad. / 10 FİYAT 50,588 TL</p> |  <p>ÜRÜN KODU 029 088 130049 ÜRÜN ADI AIRCOL COMFORT 100 ASPİRATÖR (KROM) AMBALAJ ADET / KOLİ 1 ad. / 10 FİYAT 68,235 TL</p> |  <p>ÜRÜN KODU 029 088 120100 ÜRÜN ADI AIRCOL 100 ASPİRATÖR (OTOMATİK PANJURLU) AMBALAJ ADET / KOLİ 1 ad. / 10 FİYAT 89,412 TL</p> |
|  <p>ÜRÜN KODU 029 088 110120 ÜRÜN ADI AIRCOL 120 ASPİRATÖR AMBALAJ ADET / KOLİ 1 ad. / 10 FİYAT 56,471 TL</p> |  <p>ÜRÜN KODU 029 088 130120 ÜRÜN ADI AIRCOL COMFORT 120 ASPİRATÖR (KROM) AMBALAJ ADET / KOLİ 1 ad. / 10 FİYAT 81,176 TL</p> |  <p>ÜRÜN KODU 029 088 120120 ÜRÜN ADI AIRCOL 120 ASPİRATÖR (OTOMATİK PANJURLU) AMBALAJ ADET / KOLİ 1 ad. / 10 FİYAT 103,529 TL</p> |
|  <p>ÜRÜN KODU 029 088 110150 ÜRÜN ADI AIRCOL 150 ASPİRATÖR AMBALAJ ADET / KOLİ 1 ad. / 10 FİYAT 72,941 TL</p> |  <p>ÜRÜN KODU 029 088 130051 ÜRÜN ADI AIRCOL COMFORT 150 ASPİRATÖR (KROM) AMBALAJ ADET / KOLİ 1 ad. / 10 FİYAT 90,588 TL</p> |  <p>ÜRÜN KODU 029 088 120150 ÜRÜN ADI AIRCOL 150 ASPİRATÖR (OTOMATİK PANJURLU) AMBALAJ ADET / KOLİ 1 ad. / 10 FİYAT 123,529 TL</p> |
|  <p>ÜRÜN KODU 029 088 110200 ÜRÜN ADI AIRCOL 200 ASPİRATÖR AMBALAJ ADET / KOLİ 1 ad. / 10 FİYAT 101,176 TL</p> |  <p>ÜRÜN KODU 029 088 130052 ÜRÜN ADI AIRCOL COMFORT 200 ASPİRATÖR (KROM) AMBALAJ ADET / KOLİ 1 ad. / 10 FİYAT 141,176 TL</p> |  <p>ÜRÜN KODU 029 088 140250 ÜRÜN ADI AIRCOL 250-K ASP. (TAVAN TİPİ) AMBALAJ ADET / KOLİ 1 ad. / 6 FİYAT 176,471 TL</p> |

YENİ
200'lük
SERİ

AIRCOL ASPİRATÖR ÇEŞİTLERİ

| | | |
|--|---|--|
|  <p>ÜRÜN KODU 029 088 130043 ÜRÜN ADI AIRCOL-100KT KANAL TİPİ ASPİRATÖR AMBALAJ ADET / KOLİ 1 ad. / 10 FİYAT 43,529 TL</p> |  <p>ÜRÜN KODU 029 088 130150 ÜRÜN ADI AIRCOL 150-K ASPİRATÖR (KAPAKLI) AMBALAJ ADET / KOLİ 1 ad. / 10 FİYAT 94,118 TL</p> |  <p>ÜRÜN KODU 029 088 130046 ÜRÜN ADI AIRCOL-LÜX DUVAR VE TAVAN TİPİ ASPİRATÖR AMBALAJ ADET / KOLİ 1 ad. / 6 FİYAT 188,235 TL</p> |
|  <p>ÜRÜN KODU 029 088 130044 ÜRÜN ADI AIRCOL-120KT KANAL TİPİ ASPİRATÖR AMBALAJ ADET / KOLİ 1 ad. / 10 FİYAT 50,588 TL</p> |  <p>ÜRÜN KODU 029 088 130200 ÜRÜN ADI AIRCOL 200-K ASPİRATÖR (KAPAKLI) AMBALAJ ADET / KOLİ 1 ad. / 10 FİYAT 104,706 TL</p> |  <p>ÜRÜN KODU 029 088 130250 ÜRÜN ADI AIRCOL 250-2DF DUVAR TAVAN TİPİ ASPİRATÖR AMBALAJ ADET / KOLİ 1 ad. / 10 FİYAT 211,765 TL</p> |
|  <p>ÜRÜN KODU 029 088 130045 ÜRÜN ADI AIRCOL-150KT KANAL TİPİ ASPİRATÖR AMBALAJ ADET / KOLİ 1 ad. / 10 FİYAT 64,706 TL</p> |  <p>ÜRÜN KODU 029 088 131150 ÜRÜN ADI AIRCOL-150C MP CAM VE DUVAR TİPİ ASPİRATÖR AMBALAJ ADET / KOLİ 1 ad. / 10 FİYAT 137,647 TL</p> |  <p>ÜRÜN KODU 029 088 130055 ÜRÜN ADI AIRCOL SUMMER TAVAN TİPİ ASPİRATÖR AMBALAJ ADET / KOLİ 1 ad. / 6 FİYAT 123,529 TL</p> |
|  <p>ÜRÜN KODU 029 088 125100 ÜRÜN ADI AIRCOL 100-SM ASPİRATÖR (SWİTCHLİ) AMBALAJ ADET / KOLİ 1 ad. / 10 FİYAT 61,176 TL</p> |  <p>ÜRÜN KODU 029 088 132150 ÜRÜN ADI AIRCOL-150C OP CAM VE DUVAR TİPİ ASPİRATÖR AMBALAJ ADET / KOLİ 1 ad. / 10 FİYAT 158,824 TL</p> |  <p>ÜRÜN KODU 029 088 130042 ÜRÜN ADI AIRCOL SPRİNG LIGHT TAVAN TİPİ ASPİRATÖR AMBALAJ ADET / KOLİ 1 ad. / 6 FİYAT 147,059 TL</p> |
|  <p>ÜRÜN KODU 029 088 125120 ÜRÜN ADI AIRCOL 120-SM ASPİRATÖR (SWİTCHLİ) AMBALAJ ADET / KOLİ 1 ad. / 10 FİYAT 70,588 TL</p> |  <p>ÜRÜN KODU 029 088 130020 ÜRÜN ADI AIRCOL 20-K ASPİRATÖR (KAPAKLI) AMBALAJ ADET / KOLİ 1 ad. / 10 FİYAT 123,529 TL</p> |  <p>ÜRÜN KODU 029 088 130025 ÜRÜN ADI AIRCOL 25-K ASPİRATÖR (KAPAKLI) AMBALAJ ADET / KOLİ 1 ad. / 10 FİYAT 144,706 TL</p> |
|  <p>ÜRÜN KODU 029 088 136200 ÜRÜN ADI AIRCOL-200 KF RADYAL KANAL İÇİ FAN AMBALAJ ADET / KOLİ 1 ad. FİYAT 335,294 TL</p> |  <p>ÜRÜN KODU 029 088 137120 ÜRÜN ADI AIRCOL-120 AKS SALYANGOZ RADYAL FAN AMBALAJ ADET / KOLİ 1 ad. FİYAT 247,059 TL</p> | |

| | Kod | Açıklama / Stok Cinsi | Amb. (Kutu/Bag) | Amb. (Kolu/Çv.) | FİYAT |
|---|---|--|--------------------|--------------------|---------|
|  | AIRCOL MS SERİSİ AKSİYEL FANLAR | | | | |
| | 029 088 170200 | AIRCOL-200 MS AKSİYEL FAN | 1 ad. | | 241,176 |
| | 029 088 170250 | AIRCOL-250 MS AKSİYEL FAN | 1 ad. | | 282,353 |
| | 029 088 170300 | AIRCOL-300 MS AKSİYEL FAN | 1 ad. | | 317,647 |
|  | AIRCOL S SERİSİ KARE MODEL AKSİYEL FANLAR | | | | |
| | 029 088 175300 | AIRCOL-300 S KARE MODEL | 1 ad. | | 282,353 |
| | 029 088 175400 | AIRCOL-400 S KARE MODEL | 1 ad. | | 311,765 |
| | 029 088 175450 | AIRCOL-450 S KARE MODEL | 1 ad. | | 541,176 |
| | 029 088 075500 | AIRCOL-500 S KARE MODEL | 1 ad. | | 588,235 |
|  | AIRCOL S SERİSİ SANAYİ TİPİ AKSİYEL FANLAR | | | | |
| | 029 088 130030 | AIRCOL-300 S SANAYİ TİPİ | 1 ad. | | 258,824 |
| | 029 088 130040 | AIRCOL-400 S SANAYİ TİPİ | 1 ad. | | 282,353 |
| | 029 088 130047 | AIRCOL-450 S SANAYİ TİPİ | 1 ad. | | 494,118 |
| | 029 088 130048 | AIRCOL-500 S SANAYİ TİPİ | 1 ad. | | 529,412 |
|  | AC AKSİYEL KAPAKLI ASPİRATÖRLER | | | | |
| | 080 088 200160 | BK160MM KAPAKLI ASPİRATÖR (40WATT 1200 DEV/DAK) | 1 ad. | | 142,059 |
| | 080 088 200200 | BK200MM KAPAKLI ASPİRATÖR (40WATT 1200 DEV/DAK) | 1 ad. | | 162,353 |
| | 080 088 200250 | BK250MM KAPAKLI ASPİRATÖR (50WATT 1100 DEV/DAK) | 1 ad. | | 196,176 |
| | 080 088 200300 | BK300MM KAPAKLI ASPİRATÖR (60WATT 1050 DEV/DAK) | 1 ad. | | 257,059 |
|  | AC AKSİYEL BACA ASPİRATÖRLER | | | | |
| | 080 088 160160 | BB160MM BACA ASPİRATÖR (40WATT 1200 DEV/DAK) | 1 ad. | | 128,529 |
| | 080 088 160200 | BB200MM BACA ASPİRATÖR (40WATT 1200 DEV/DAK) | 1 ad. | | 142,059 |
| | 080 088 160250 | BB250MM BACA ASPİRATÖR (50WATT 1100 DEV/DAK) | 1 ad. | | 182,647 |
| | 080 088 160300 | BB300MM BACA ASPİRATÖR (60WATT 1050 DEV/DAK) | 1 ad. | | 230,000 |
|  | MONOFAZE SANAYİ TİPİ ASPİRATÖRLER | | | | |
| | 080 088 002250 | BSM250-2K MONOFAZE SANAYİ ASP. (180W 2900 DEV/DAK) | 1 ad. | | 401,824 |
| | 080 088 000250 | BSM250 MONOFAZE SANAYİ ASP. (160W 1480 DEV/DAK) | 1 ad. | | 349,735 |
| | 080 088 000300 | BSM300 MONOFAZE SANAYİ ASP. (180W 1400 DEV/DAK) | 1 ad. | | 364,618 |
| | 080 088 000350 | BSM350 MONOFAZE SANAYİ ASP. (200W 1450 DEV/DAK) | 1 ad. | | 386,941 |
| | 080 088 000400 | BSM400 MONOFAZE SANAYİ ASP. (220W 1450 DEV/DAK) | 1 ad. | | 424,147 |
| | 080 088 000450 | BSM450 MONOFAZE SANAYİ ASP. (240W 1400 DEV/DAK) | 1 ad. | | 461,353 |
| | 080 088 000500 | BSM500 MONOFAZE SANAYİ ASP. (280W 1400 DEV/DAK) | 1 ad. | | 491,118 |
| | 080 088 000550 | BSM550 MONOFAZE SANAYİ ASP. (290W 1400 DEV/DAK) | 1 ad. | | 625,059 |
| | 080 088 000600 | BSM600 MONOFAZE SANAYİ ASP. (310W 1400 DEV/DAK) | 1 ad. | | 625,059 |
| |  | TRİFAZE SANAYİ TİPİ ASPİRATÖRLER | | | |
| 080 088 102250 | | BST250-2K TRİFAZE SANAYİ ASP. (180W 2800 DEV/DAK) | 1 ad. | | 401,824 |
| 080 088 100250 | | BST250 TRİFAZE SANAYİ ASP. (100W 1400 DEV/DAK) | 1 ad. | | 349,735 |
| 080 088 100300 | | BST300 TRİFAZE SANAYİ ASP. (125W 1400 DEV/DAK) | 1 ad. | | 364,618 |
| 080 088 100350 | | BST350 TRİFAZE SANAYİ ASP. (175W 1400 DEV/DAK) | 1 ad. | | 386,941 |
| 080 088 100400 | | BST400 TRİFAZE SANAYİ ASP. (170W 1400 DEV/DAK) | 1 ad. | | 424,147 |
| 080 088 100450 | | BST450 TRİFAZE SANAYİ ASP. (210W 1400 DEV/DAK) | 1 ad. | | 461,353 |
| 080 088 100500 | | BST500 TRİFAZE SANAYİ ASP. (230W 1400 DEV/DAK) | 1 ad. | | 491,118 |
| 080 088 100550 | | BST550 TRİFAZE SANAYİ ASP. (220W 1400 DEV/DAK) | 1 ad. | | 625,059 |
| 080 088 100600 | | BST600 TRİFAZE SANAYİ ASP. (200W 1400 DEV/DAK) | 1 ad. | | 625,059 |
|  | AC RADYAL FANLAR (SAC GÖVDELİ) | | | | |
| | 080 088 012550 | BDRS 125-50 AC RADYAL FAN (97W 2450 DEV/DAK) | 1 ad. | | 282,765 |
| | 080 088 012060 | BDRS 120-60 AC RADYAL FAN (90W 2400 DEV/DAK) | 1 ad. | | 282,765 |
| | 080 088 014060 | BDRS 140-60 AC RADYAL FAN (160W 2300 DEV/DAK) | 1 ad. | | 327,412 |
| 080 088 016060 | BDRS 160-60 AC RADYAL FAN (225W 2200 DEV/DAK) | 1 ad. | | 372,059 | |
|  | AC TEK GİRİŞLİ SALYANGOZ FANLAR | | | | |
| | 080 088 000140 | OBR140M-2K SALYANGOZ FAN (250W 2800 D/D) | 1 ad. | | 401,824 |
| | 080 088 002200 | OBR200M-2K SALYANGOZ FAN (620W 2800 D/D) | 1 ad. | | 446,471 |
| | 080 088 002400 | OBR200M-4K SALYANGOZ FAN (200W 1450 D/D) | 1 ad. | | 446,471 |
| | 080 088 002220 | OBR200T-2K SALYANGOZ FAN (600W 2800 D/D) | 1 ad. | | 446,471 |
| | 080 088 002410 | OBR200T-4K SALYANGOZ FAN (130W 1400 D/D) | 1 ad. | | 446,471 |

CAMALEX
EKO SERISI
MEKS SERISI

LED AYDINLATMA

SERISI
LED PANELLER
MEKS PLUS
H. FR
SPILLARER
COMFORT SERISI



LED Panel Montaj Tipleri

LED Panel Installation Types

Bu Üründe
OSRAM LED ve
PHILIPS Driver
kullanılmıştır.



Sıva Altı

Recessed LED Panel

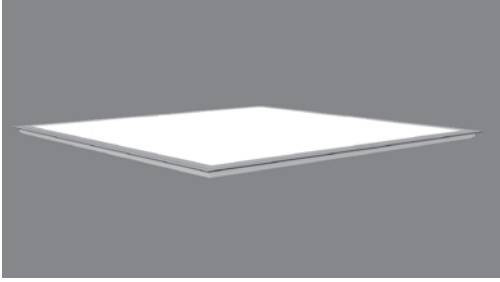

| | |
|--------------------------|----------------------------|
| Boyut | 595x595x16 mm |
| Ağırlık | 3 kg |
| Giriş Voltajı | 220-240 V AC - 50/60hz |
| Işık Kaynağı | OSRAM LED |
| Tüketil Gücü | 35 W |
| Işık Renkleri | 3000K, 6500K |
| Kullanım Ömrü | 50.000 h(L ₇₀) |
| Ortam Sıcaklığı | -25 °C / +45 °C |
| Işık Akışı | 3000 lm |
| Verimlilik | 85 lm/W |
| Genkrel Geriverim Değeri | ≥ 80 (typ.85) |
| Garanti (Yıl) | 3 |

| KOD | AÇIKLAMA | Ambalaj | Fiyat |
|-----------------|----------------------|---------|-----------|
| 006 087 00 xxxx | 60x60 Slim Led Panel | 1 ad. | 80,000 \$ |

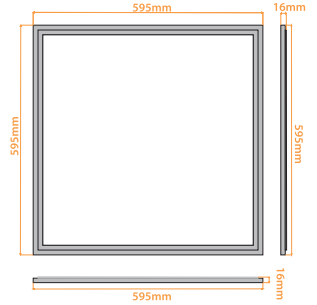

Clip-in

Clip-in



| | |
|--------------------------|----------------------------|
| Boyut | 597x597x25 mm |
| Ağırlık | 3 kg |
| Giriş Voltajı | 220-240 V AC - 50/60hz |
| Işık Kaynağı | OSRAM LED |
| Tüketil Gücü | 35 W |
| Işık Renkleri | 3000K, 6500K |
| Kullanım Ömrü | 50.000 h(L ₇₀) |
| Ortam Sıcaklığı | -25 °C / +45 °C |
| Işık Akışı | 3000 lm |
| Verimlilik | 85 lm/W |
| Genkrel Geriverim Değeri | ≥ 80 (typ.85) |
| Garanti (Yıl) | 3 |

| KOD | AÇIKLAMA | Ambalaj | Fiyat |
|-----------------|----------------------|---------|-----------|
| 006 087 00 xxxx | 60x60 Slim Led Panel | 1 ad. | 80,000 \$ |
| 999 999 999322 | Clip-in Aparat 60x60 | 1 ad. | 14,882 \$ |

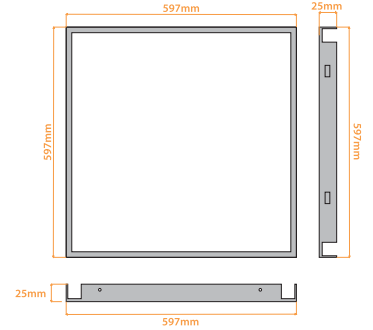

Alçı Tavan

LED Panel for gypsum ceiling



| | |
|--------------------------|----------------------------|
| Boyut | 595x595x16 mm |
| Ağırlık | 3 kg |
| Giriş Voltajı | 220-240 V AC - 50/60hz |
| Işık Kaynağı | OSRAM LED |
| Tüketil Gücü | 35 W |
| Işık Renkleri | 3000K, 6500K |
| Kullanım Ömrü | 50.000 h(L ₇₀) |
| Ortam Sıcaklığı | -25 °C / +45 °C |
| Işık Akışı | 3000 lm |
| Verimlilik | 85 lm/W |
| Genkrel Geriverim Değeri | ≥ 80 (typ.85) |
| Garanti (Yıl) | 3 |

| KOD | AÇIKLAMA | Ambalaj | Fiyat |
|-----------------|----------------------|---------|-----------|
| 006 087 00 xxxx | 60x60 Slim Led Panel | 1 ad. | 80,000 \$ |
| 999 999 999320 | Alçıpan Aparat 60x60 | 1 ad. | 8,929 \$ |

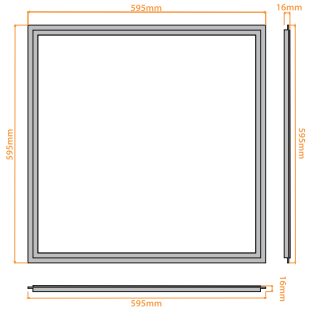

Sıva Üstü

Surface Mounted LED Panel



| | |
|--------------------------|----------------------------|
| Boyut | 597x597x50 mm |
| Ağırlık | 3 kg |
| Giriş Voltajı | 220-240 V AC - 50/60hz |
| Işık Kaynağı | OSRAM LED |
| Tüketil Gücü | 35 W |
| Işık Renkleri | 3000K, 6500K |
| Kullanım Ömrü | 70.000 h(L ₇₀) |
| Ortam Sıcaklığı | -25 °C / +45 °C |
| Işık Akışı | 3000 lm |
| Verimlilik | 85 lm/W |
| Genkrel Geriverim Değeri | ≥ 80 (typ.85) |
| Garanti (Yıl) | 3 |

| KOD | AÇIKLAMA | Ambalaj | Fiyat |
|-----------------|----------------------|---------|-----------|
| 006 087 00 xxxx | 60x60 Slim Led Panel | 1 ad. | 80,000 \$ |
| 999 999 999321 | S/Ü Aparat 60x60 | 1 ad. | 20,835 \$ |

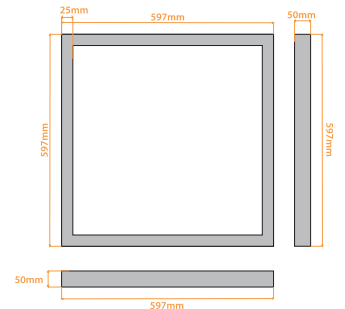

RENK KODU: Sonu xxxx ile belirtilen kodlar için ışık renk kodunu lütfen siparişte bildiriniz.

Aynı Markalı Ürünün 30x30 30x60 30x115 Ölçüleri Bulunmaktadır. Bu Ürünler için Fiyat İsteyiniz.



DOWNLIGHT BACKLIGHT LED ARMATÜRLER

| Kod | Wat | Ölçüsü | Kelvin | Lumen | CRI | Armatür Ölçüsü(mm) | Kesim Ölçüsü(mm) | IP Sınıfı | Kutu/Koli | Fiyat |
|----------------|-----|--------|--------|-------|-----|--------------------|------------------|-----------|-----------|----------|
| 016 038 302008 | 8 | 2,5 | 3000 | 720 | 85+ | 90x25 | 80 | 20 | 1/40 | 25,60 \$ |
| 016 038 302012 | 12 | 4 | 3000 | 1116 | 85+ | 122x25 | 105 | 20 | 1/40 | 31,55 \$ |
| 016 038 302018 | 18 | 6 | 3000 | 1710 | 85+ | 175x25 | 155 | 20 | 1/25 | 35,12 \$ |
| 016 038 302023 | 23 | 8 | 3000 | 2230 | 85+ | 225x25 | 200 | 20 | 1/25 | 44,65 \$ |
| 016 038 402008 | 8 | 2,5 | 4000 | 720 | 85+ | 90x25 | 80 | 20 | 1/40 | 25,60 \$ |
| 016 038 402012 | 12 | 4 | 4000 | 1116 | 85+ | 122x25 | 105 | 20 | 1/40 | 31,55 \$ |
| 016 038 402018 | 18 | 6 | 4000 | 1710 | 85+ | 175x25 | 155 | 20 | 1/25 | 35,12 \$ |
| 016 038 402023 | 23 | 8 | 4000 | 2230 | 85+ | 225x25 | 200 | 20 | 1/25 | 44,65 \$ |
| 016 038 602008 | 8 | 2,5 | 6000 | 720 | 85+ | 90x25 | 80 | 20 | 1/40 | 25,60 \$ |
| 016 038 602012 | 12 | 4 | 6000 | 1116 | 85+ | 122x25 | 105 | 20 | 1/40 | 31,55 \$ |
| 016 038 602018 | 18 | 6 | 6000 | 1710 | 85+ | 175x25 | 155 | 20 | 1/25 | 35,12 \$ |
| 016 038 602023 | 23 | 8 | 6000 | 2230 | 85+ | 225x25 | 200 | 20 | 1/25 | 44,65 \$ |

ACİL KİT / RADAR SENSÖR / DALİ SİSTEM için Fiyat Alınır



Bu Üründe

LED: **OSRAM** ve **SAMSUNG**
Driver: **OSRAM** ve **PHILIPS**

BACKLIGHT
LED 30x30
ARMATÜR

30x30 LED ARMATÜR - CLIPP-IN TAVAN

| Kod | Wat | Kelvin | Lumen | CRI | Armatür Ölçüsü(mm) | Kesim Ölçüsü(mm) | IP Sınıfı | Kutu/Koli | Fiyat |
|----------------|-----|--------|-------|-----|--------------------|------------------|-----------|-----------|----------|
| 016 038 314030 | 15 | 3000 | 1515 | 85+ | 297x297x45 | | 40 | 2/10 | 49,11 \$ |
| 016 038 314040 | 15 | 4000 | 1515 | 85+ | 297x297x45 | | 40 | 2/10 | 49,11 \$ |
| 016 038 314060 | 15 | 6000 | 1515 | 85+ | 297x297x45 | | 40 | 2/10 | 49,11 \$ |
| 016 038 315430 | 15 | 3000 | 1515 | 85+ | 297x297x45 | | 54 | 2/10 | 62,51 \$ |
| 016 038 315440 | 15 | 4000 | 1515 | 85+ | 297x297x45 | | 54 | 2/10 | 62,51 \$ |
| 016 038 315460 | 15 | 6000 | 1515 | 85+ | 297x297x45 | | 54 | 2/10 | 62,51 \$ |

30x30 LED ARMATÜR - TAŞYÜNÜ TAVAN

| Kod | Wat | Kelvin | Lumen | CRI | Armatür Ölçüsü(mm) | Kesim Ölçüsü(mm) | IP Sınıfı | Kutu/Koli | Fiyat |
|----------------|-----|--------|-------|-----|--------------------|------------------|-----------|-----------|----------|
| 016 038 324030 | 15 | 3000 | 1515 | 85+ | 297x297x45 | | 40 | 2/10 | 44,05 \$ |
| 016 038 324040 | 15 | 4000 | 1515 | 85+ | 297x297x45 | | 40 | 2/10 | 44,05 \$ |
| 016 038 324060 | 15 | 6000 | 1515 | 85+ | 297x297x45 | | 40 | 2/10 | 44,05 \$ |
| 016 038 325430 | 15 | 3000 | 1515 | 85+ | 297x297x45 | | 54 | 2/10 | 57,45 \$ |
| 016 038 325440 | 15 | 4000 | 1515 | 85+ | 297x297x45 | | 54 | 2/10 | 57,45 \$ |
| 016 038 325460 | 15 | 6000 | 1515 | 85+ | 297x297x45 | | 54 | 2/10 | 57,45 \$ |

30x30 LED ARMATÜR - ALÇIPAN TAVAN

| Kod | Wat | Kelvin | Lumen | CRI | Armatür Ölçüsü(mm) | Kesim Ölçüsü(mm) | IP Sınıfı | Kutu/Koli | Fiyat |
|----------------|-----|--------|-------|-----|--------------------|------------------|-----------|-----------|----------|
| 016 038 334030 | 15 | 3000 | 1515 | 85+ | 297x297x45 | 275X275 | 40 | 2/10 | 46,14 \$ |
| 016 038 334040 | 15 | 4000 | 1515 | 85+ | 297x297x45 | 275X275 | 40 | 2/10 | 46,14 \$ |
| 016 038 334060 | 15 | 6000 | 1515 | 85+ | 297x297x45 | 275X275 | 40 | 2/10 | 46,14 \$ |
| 016 038 335430 | 15 | 3000 | 1515 | 85+ | 297x297x45 | 275X275 | 54 | 2/10 | 59,53 \$ |
| 016 038 335440 | 15 | 4000 | 1515 | 85+ | 297x297x45 | 275X275 | 54 | 2/10 | 59,53 \$ |
| 016 038 335460 | 15 | 6000 | 1515 | 85+ | 297x297x45 | 275X275 | 54 | 2/10 | 59,53 \$ |

30x30 LED ARMATÜR - SIVA ÜSTÜ

| Kod | Wat | Kelvin | Lumen | CRI | Armatür Ölçüsü(mm) | Kesim Ölçüsü(mm) | IP Sınıfı | Kutu/Koli | Fiyat |
|----------------|-----|--------|-------|-----|--------------------|------------------|-----------|-----------|----------|
| 016 038 344030 | 15 | 3000 | 1515 | 85+ | 310X310 | | 40 | 2/10 | 52,09 \$ |
| 016 038 344040 | 15 | 4000 | 1515 | 85+ | 310X310 | | 40 | 2/10 | 52,09 \$ |
| 016 038 344060 | 15 | 6000 | 1515 | 85+ | 310X310 | | 40 | 2/10 | 52,09 \$ |
| 016 038 345430 | 15 | 3000 | 1515 | 85+ | 310X310 | | 54 | 2/10 | 65,48 \$ |
| 016 038 345440 | 15 | 4000 | 1515 | 85+ | 310X310 | | 54 | 2/10 | 65,48 \$ |
| 016 038 345460 | 15 | 6000 | 1515 | 85+ | 310X310 | | 54 | 2/10 | 65,48 \$ |

ACİL KİT / RADAR SENSÖR / DALİ SİSTEM için Fiyat Alınır



Bu Üründe

LED: **OSRAM** ve **SAMSUNG**
Driver: **OSRAM** ve **PHILIPS**

BACKLIGHT
LED
ARMATÜR **60x60**

60x60 LED ARMATÜR - CLIPP-IN TAVAN

| Kod | Wat | Kelvin | Lumen | CRI | Armatür Ölçüsü(mm) | Kesim Ölçüsü(mm) | IP Sınıfı | Kutu/Koli | Fiyat |
|----------------|-----|--------|-------|-----|--------------------|------------------|-----------|-----------|----------|
| 016 038 614030 | 35 | 3000 | 3390 | 85+ | 595X595x65 | | 40 | 2/8 | 83,34 \$ |
| 016 038 614040 | 35 | 4000 | 3390 | 85+ | 595X595x65 | | 40 | 2/8 | 83,34 \$ |
| 016 038 614060 | 35 | 6000 | 3390 | 85+ | 595X595x65 | | 40 | 2/8 | 83,34 \$ |
| 016 038 615430 | 35 | 3000 | 3390 | 85+ | 595X595x65 | | 54 | 2/8 | 98,22 \$ |
| 016 038 615440 | 35 | 4000 | 3390 | 85+ | 595X595x65 | | 54 | 2/8 | 98,22 \$ |
| 016 038 615460 | 35 | 6000 | 3390 | 85+ | 595X595x65 | | 54 | 2/8 | 98,22 \$ |

60x60 LED ARMATÜR - TAŞYÜNÜ TAVAN

| Kod | Wat | Kelvin | Lumen | CRI | Armatür Ölçüsü(mm) | Kesim Ölçüsü(mm) | IP Sınıfı | Kutu/Koli | Fiyat |
|----------------|-----|--------|-------|-----|--------------------|------------------|-----------|-----------|----------|
| 016 038 624030 | 35 | 3000 | 3390 | 85+ | 595X595x65 | | 40 | 2/8 | 69,95 \$ |
| 016 038 624040 | 35 | 4000 | 3390 | 85+ | 595X595x65 | | 40 | 2/8 | 69,95 \$ |
| 016 038 624060 | 35 | 6000 | 3390 | 85+ | 595X595x65 | | 40 | 2/8 | 69,95 \$ |
| 016 038 625430 | 35 | 3000 | 3390 | 85+ | 595X595x65 | | 54 | 2/8 | 86,32 \$ |
| 016 038 625440 | 35 | 4000 | 3390 | 85+ | 595X595x65 | | 54 | 2/8 | 86,32 \$ |
| 016 038 625460 | 35 | 6000 | 3390 | 85+ | 595X595x65 | | 54 | 2/8 | 86,32 \$ |

60x60 LED ARMATÜR - ALÇIPAN TAVAN

| Kod | Wat | Kelvin | Lumen | CRI | Armatür Ölçüsü(mm) | Kesim Ölçüsü(mm) | IP Sınıfı | Kutu/Koli | Fiyat |
|----------------|-----|--------|-------|-----|--------------------|------------------|-----------|-----------|----------|
| 016 038 634030 | 35 | 3000 | 3390 | 85+ | 595X595x65 | 575X575 | 40 | 2/8 | 74,41 \$ |
| 016 038 634040 | 35 | 4000 | 3390 | 85+ | 595X595x65 | 575X575 | 40 | 2/8 | 74,41 \$ |
| 016 038 634060 | 35 | 6000 | 3390 | 85+ | 595X595x65 | 575X575 | 40 | 2/8 | 74,41 \$ |
| 016 038 635430 | 35 | 3000 | 3390 | 85+ | 595X595x65 | 575X575 | 54 | 2/8 | 89,29 \$ |
| 016 038 635440 | 35 | 4000 | 3390 | 85+ | 595X595x65 | 575X575 | 54 | 2/8 | 89,29 \$ |
| 016 038 635460 | 35 | 6000 | 3390 | 85+ | 595X595x65 | 575X575 | 54 | 2/8 | 89,29 \$ |

60x60 LED ARMATÜR - SIVA ÜSTÜ

| Kod | Wat | Kelvin | Lumen | CRI | Armatür Ölçüsü(mm) | Kesim Ölçüsü(mm) | IP Sınıfı | Kutu/Koli | Fiyat |
|----------------|-----|--------|-------|-----|--------------------|------------------|-----------|-----------|-----------|
| 016 038 644030 | 35 | 3000 | 3390 | 85+ | 610X610x75 | | 40 | 2/4 | 87,81 \$ |
| 016 038 644040 | 35 | 4000 | 3390 | 85+ | 610X610x75 | | 40 | 2/4 | 87,81 \$ |
| 016 038 644060 | 35 | 6000 | 3390 | 85+ | 610X610x75 | | 40 | 2/4 | 87,81 \$ |
| 016 038 645430 | 35 | 3000 | 3390 | 85+ | 610X610x75 | | 54 | 2/4 | 101,20 \$ |
| 016 038 645440 | 35 | 4000 | 3390 | 85+ | 610X610x75 | | 54 | 2/4 | 101,20 \$ |
| 016 038 645460 | 35 | 6000 | 3390 | 85+ | 610X610x75 | | 54 | 2/4 | 101,20 \$ |

ACİL KİT / RADAR SENSÖR / DALİ SİSTEM için Fiyat Alınız



Bu Üründe

LED: **OSRAM** ve **SAMSUNG**
Driver: **OSRAM** ve **PHILIPS**

BACKLIGHT
HYGIENE
BACKLIGHT **60x60**

60x60 HYGIENE BACKLIGHT LED ARMATÜR

| Kod | Wat | Kelvin | Lumen | CRI | Armatür Ölçüsü(mm) | Kesim Ölçüsü(mm) | IP Sınıfı | Kutu/Koli | Fiyat |
|----------------|-----|--------|-------|-----|--------------------|------------------|-----------|-----------|-----------|
| 000 000 000000 | 42 | 3000 | 4000 | 85+ | 595X595X82 | 575X575 | 65 | 2/4 | 223,24 \$ |
| | 42 | 4000 | 4000 | 85+ | 595X595X82 | 575X575 | 65 | 2/4 | 223,24 \$ |
| | 42 | 6000 | 4000 | 85+ | 595X595X82 | 575X575 | 65 | 2/4 | 223,24 \$ |

ACİL KİT / RADAR SENSÖR / DALİ SİSTEM için Fiyat Alınız

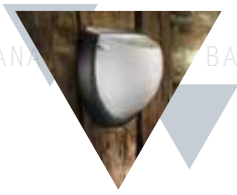

Bu Üründe

LED: **OSRAM** ve **SAMSUNG**
Driver: **OSRAM** ve **PHILIPS**

PC CAM PC GÖVDE LED ETANJ ARMATÜR

60 CM PC GÖVDE-PC CAM LED ETANJ ARMATÜRLER

| Kod | Wat | Kelvin | Lumen | CRI | Armatür Ölçüsü(mm) | IP Sınıfı | Kutu/Koli | Fiyat |
|----------------|-----|--------|-------|-----|--------------------|-----------|-----------|----------|
| 016 038 666530 | 10 | 3000 | 950 | 85+ | 675x95x94 | 65 | 1/16 | 49,11 \$ |
| 016 038 666540 | 10 | 4000 | 950 | 85+ | 675x95x94 | 65 | 1/16 | 49,11 \$ |
| 016 038 666560 | 10 | 6000 | 950 | 85+ | 675x95x94 | 65 | 1/16 | 49,11 \$ |
| 016 038 676530 | 20 | 3000 | 1880 | 85+ | 675x95x94 | 65 | 1/16 | 56,55 \$ |
| 016 038 676540 | 20 | 4000 | 1880 | 85+ | 675x95x94 | 65 | 1/16 | 56,55 \$ |
| 016 038 676560 | 20 | 6000 | 1880 | 85+ | 675x95x94 | 65 | 1/16 | 56,55 \$ |

120 CM PC GÖVDE-PC CAM LED ETANJ ARMATÜRLER

| Kod | Wat | Kelvin | Lumen | CRI | Armatür Ölçüsü(mm) | IP Sınıfı | Kutu/Koli | Fiyat |
|----------------|-----|--------|-------|-----|--------------------|-----------|-----------|----------|
| 016 038 686530 | 20 | 3000 | 1880 | 85+ | 1283x95x94 | 65 | 1/9 | 66,97 \$ |
| 016 038 686540 | 20 | 4000 | 1880 | 85+ | 1283x95x94 | 65 | 1/9 | 66,97 \$ |
| 016 038 686560 | 20 | 6000 | 1880 | 85+ | 1283x95x94 | 65 | 1/9 | 66,97 \$ |
| 016 038 696530 | 40 | 3000 | 3760 | 85+ | 1283x95x94 | 65 | 1/9 | 81,85 \$ |
| 016 038 696540 | 40 | 4000 | 3760 | 85+ | 1283x95x94 | 65 | 1/9 | 81,85 \$ |
| 016 038 696560 | 40 | 6000 | 3760 | 85+ | 1283x95x94 | 65 | 1/9 | 81,85 \$ |

ACİL KİT / RADAR SENSÖR / DALI SİSTEM için Fiyat Alınız



Bu Üründe

LED: **OSRAM** ve **SAMSUNG**
Driver: **OSRAM** ve **PHILIPS**

ALÜMİNYUM GÖVDE PC CAM LED ETANJ ARMATÜR



60 CM ALÜMİNYUM GÖVDE ve PC CAM LED ETANJ ARMATÜRLER

| Kod | Wat | Kelvin | Lumen | CRI | Armatür Ölçüsü(mm) | IP Sınıfı | Kutu/Koli | Fiyat |
|----------------|-----|--------|-------|-----|--------------------|-----------|-----------|----------|
| 016 038 705430 | 10 | 3000 | 950 | 85+ | 600X85x115 | 54 | 1 | 62,51 \$ |
| 016 038 705440 | 10 | 4000 | 950 | 85+ | 600X85x115 | 54 | 1 | 62,51 \$ |
| 016 038 705460 | 10 | 6000 | 950 | 85+ | 600X85x115 | 54 | 1 | 62,51 \$ |
| 016 038 715430 | 20 | 3000 | 1900 | 85+ | 600X85x115 | 54 | 1 | 68,46 \$ |
| 016 038 715440 | 20 | 4000 | 1900 | 85+ | 600X85x115 | 54 | 1 | 68,46 \$ |
| 016 038 715460 | 20 | 6000 | 1900 | 85+ | 600X85x115 | 54 | 1 | 68,46 \$ |

120 CM ALÜMİNYUM GÖVDE ve PC CAM LED ETANJ ARMATÜRLER

| Kod | Wat | Kelvin | Lumen | CRI | Armatür Ölçüsü(mm) | IP Sınıfı | Kutu/Koli | Fiyat |
|----------------|-----|--------|-------|-----|--------------------|-----------|-----------|-----------|
| 016 038 725430 | 20 | 3000 | 1900 | 85+ | 1200X85x115 | 54 | 1 | 89,29 \$ |
| 016 038 725440 | 20 | 4000 | 1900 | 85+ | 1200X85x115 | 54 | 1 | 89,29 \$ |
| 016 038 725460 | 20 | 6000 | 1900 | 85+ | 1200X85x115 | 54 | 1 | 89,29 \$ |
| 016 038 735430 | 40 | 3000 | 3800 | 85+ | 1200X85x115 | 54 | 1 | 104,18 \$ |
| 016 038 735440 | 40 | 4000 | 3800 | 85+ | 1200X85x115 | 54 | 1 | 104,18 \$ |
| 016 038 735460 | 40 | 6000 | 3800 | 85+ | 1200X85x115 | 54 | 1 | 104,18 \$ |

150 CM ALÜMİNYUM GÖVDE ve PC CAM LED ETANJ ARMATÜRLER

| Kod | Wat | Kelvin | Lumen | CRI | Armatür Ölçüsü(mm) | IP Sınıfı | Kutu/Koli | Fiyat |
|----------------|-----|--------|-------|-----|--------------------|-----------|-----------|-----------|
| 016 038 745430 | 40 | 3000 | 3800 | 85+ | 1500X85x115 | 54 | 1 | 113,11 \$ |
| 016 038 745440 | 40 | 4000 | 3800 | 85+ | 1500X85x115 | 54 | 1 | 113,11 \$ |
| 016 038 745460 | 40 | 6000 | 3800 | 85+ | 1500X85x115 | 54 | 1 | 113,11 \$ |
| 016 038 755430 | 50 | 3000 | 4700 | 85+ | 1500X85x115 | 54 | 1 | 127,99 \$ |
| 016 038 755440 | 50 | 4000 | 4700 | 85+ | 1500X85x115 | 54 | 1 | 127,99 \$ |
| 016 038 755460 | 50 | 6000 | 4700 | 85+ | 1500X85x115 | 54 | 1 | 127,99 \$ |

ACİL KİT / RADAR SENSÖR / DALI SİSTEM için Fiyat Alınız



Radar Sensörlü



YENİ
ÜRÜNLERİMİZ

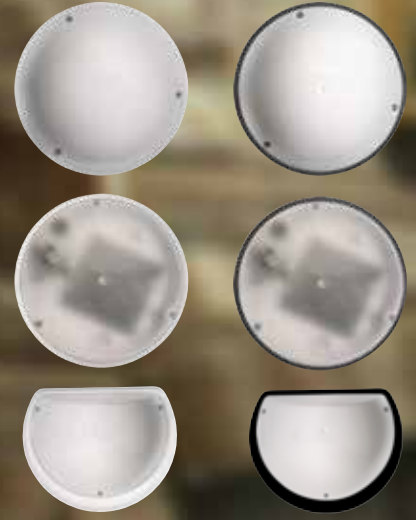

LEDLİ OPAK ARMATÜR ve APLİK

| Kod | Açıklama | Wat | Kelvin | IP Sınıfı | Renk | Adet | Koli | Fiyat |
|----------------|----------------------------|------|--------|-----------|-------|-------|------|--------|
| 016 038 411600 | DOLUNAY OPAK ARMATÜR LEDLİ | 12 W | 3000K | IP54 | BEYAZ | 1 ad. | 16 | 33,485 |
| 016 038 411700 | DOLUNAY OPAK ARMATÜR LEDLİ | 12 W | 6400K | IP54 | BEYAZ | 1 ad. | 16 | 33,485 |
| 016 038 411611 | DOLUNAY OPAK ARMATÜR LEDLİ | 12 W | 3000K | IP54 | SİYAH | 1 ad. | 16 | 33,485 |
| 016 038 411711 | DOLUNAY OPAK ARMATÜR LEDLİ | 12 W | 6400K | IP54 | SİYAH | 1 ad. | 16 | 33,485 |
| 016 038 412300 | DOLUNAY OPAK APLİK LEDLİ | 9 W | 3000K | IP54 | BEYAZ | 1 ad. | 16 | 32,741 |
| 016 038 412400 | DOLUNAY OPAK APLİK LEDLİ | 9 W | 6400K | IP54 | BEYAZ | 1 ad. | 16 | 32,741 |
| 016 038 412311 | DOLUNAY OPAK APLİK LEDLİ | 9 W | 3000K | IP54 | SİYAH | 1 ad. | 16 | 32,741 |
| 016 038 412411 | DOLUNAY OPAK APLİK LEDLİ | 9 W | 6400K | IP54 | SİYAH | 1 ad. | 16 | 32,741 |

LEDLİ MAKRO SENSÖRLÜ OPAK ARMATÜR ve APLİK

| Kod | Açıklama | Wat | Kelvin | IP Sınıfı | Renk | Adet | Koli | Fiyat |
|----------------|---|------|--------|-----------|-------|-------|------|--------|
| 016 038 412500 | DOLUNAY OPAK ARMATÜR LEDLİ MAKRO SENSÖRLÜ | 12 W | 3000K | IP54 | BEYAZ | 1 ad. | 16 | 74,412 |
| 016 038 412511 | DOLUNAY OPAK ARMATÜR LEDLİ MAKRO SENSÖRLÜ | 12 W | 6400K | IP54 | SİYAH | 1 ad. | 16 | 74,412 |
| 016 038 412600 | DOLUNAY OPAK ARMATÜR LEDLİ MAKRO SENSÖRLÜ | 12 W | 3000K | IP54 | BEYAZ | 1 ad. | 16 | 74,412 |
| 016 038 412611 | DOLUNAY OPAK ARMATÜR LEDLİ MAKRO SENSÖRLÜ | 12 W | 6400K | IP54 | SİYAH | 1 ad. | 16 | 74,412 |
| 016 038 411400 | DOLUNAY OPAK APLİK LEDLİ MAKRO SENSÖRLÜ | 9 W | 3000K | IP54 | BEYAZ | 1 ad. | 16 | 74,412 |
| 016 038 411411 | DOLUNAY OPAK APLİK LEDLİ MAKRO SENSÖRLÜ | 9 W | 6400K | IP54 | SİYAH | 1 ad. | 16 | 74,412 |
| 016 038 411500 | DOLUNAY OPAK APLİK LEDLİ MAKRO SENSÖRLÜ | 9 W | 3000K | IP54 | BEYAZ | 1 ad. | 16 | 74,412 |
| 016 038 411511 | DOLUNAY OPAK APLİK LEDLİ MAKRO SENSÖRLÜ | 9 W | 6400K | IP54 | SİYAH | 1 ad. | 16 | 74,412 |

MAKRO SENSÖRLÜ OPAK ARMATÜR ve APLİK

| Kod | Açıklama | Duy | IP | Renk | Adet | Koli | Fiyat |
|----------------|---------------------------------------|-------|------|-------|-------|------|--------|
| 016 038 411900 | DOLUNAY OPAK ARMATÜR MAKRO SENSÖRLÜ | 1xE27 | IP54 | BEYAZ | 1 ad. | 16 | 57,297 |
| 016 038 411911 | DOLUNAY OPAK ARMATÜR MAKRO SENSÖRLÜ | 1xE27 | IP54 | SİYAH | 1 ad. | 16 | 57,297 |
| 016 038 411800 | DOLUNAY ŞEFFAF ARMATÜR MAKRO SENSÖRLÜ | 1xE27 | IP54 | BEYAZ | 1 ad. | 16 | 57,297 |
| 016 038 411811 | DOLUNAY ŞEFFAF ARMATÜR MAKRO SENSÖRLÜ | 1xE27 | IP54 | SİYAH | 1 ad. | 16 | 57,297 |
| 016 038 412800 | DOLUNAY OPAK APLİK MAKRO SENSÖRLÜ | 1xE27 | IP54 | BEYAZ | 1 ad. | 16 | 57,297 |
| 016 038 412811 | DOLUNAY OPAK APLİK MAKRO SENSÖRLÜ | 1xE27 | IP54 | SİYAH | 1 ad. | 16 | 57,297 |
| 016 038 412700 | DOLUNAY ŞEFFAF APLİK MAKRO SENSÖRLÜ | 1xE27 | IP54 | BEYAZ | 1 ad. | 16 | 57,297 |
| 016 038 412711 | DOLUNAY ŞEFFAF APLİK MAKRO SENSÖRLÜ | 1xE27 | IP54 | SİYAH | 1 ad. | 16 | 57,297 |



Radar Sensörlü



YENİ
ÜRÜNLERİMİZ

LED Mikrodalga (Radar) Sensörlü Tavan Aydınlatma

Güç: 15W

Çalışma Voltajı: 85V-270V

Ölçü(MM) :260 MM

Metal Taban / Plastik Gövde

LED :SMD 57/30

Lümen: 900-980 lm

Renk :6500k

Çalışma süresi : 50 000h

Radar sensörü Algılama : Çap: = 10-12 M

Yüksek duyarlılık

Çalışma açısı :180° x 360°

KOLİ ADEDİ : 20

Fiyat:
124,268 TL



Ürün Kodu: 016 038 250081

Ürün Adı : Radar Sens. Led Arm Sofia-1

Ürün Kodu: 016 038 250082

Ürün Adı : Radar Sens. Led Arm Sofia-2



Ürün Kodu: 016 038 250083

Ürün Adı : Radar Sens. Led Arm Sofia-3

Ürün Kodu: 016 038 250084

Ürün Adı : Radar Sens. Led Arm Sofia-4

LED Tavan Aydınlatma

Metal Taban / Plastik Gövde

Güç: 15W

Çalışma Voltajı: 85V-270V

Ölçü(MM) :260 MM

LED :SMD 57/30

Lümen: 900-980 lm

Renk :6500k

Çalışma süresi : 50 000 S

KOLİ ADEDİ : 20

Fiyat:
90,782 TL



Ürün Kodu: 016 038 250071

Ürün Adı : Led Aydınlatma Sidem-1

Ürün Kodu: 016 038 250072

Ürün Adı : Led Aydınlatma Sidem-2



Ürün Kodu: 016 038 250073

Ürün Adı : Led Aydınlatma Sidem-3

Ürün Kodu: 016 038 250074

Ürün Adı : Led Aydınlatma Sidem-4

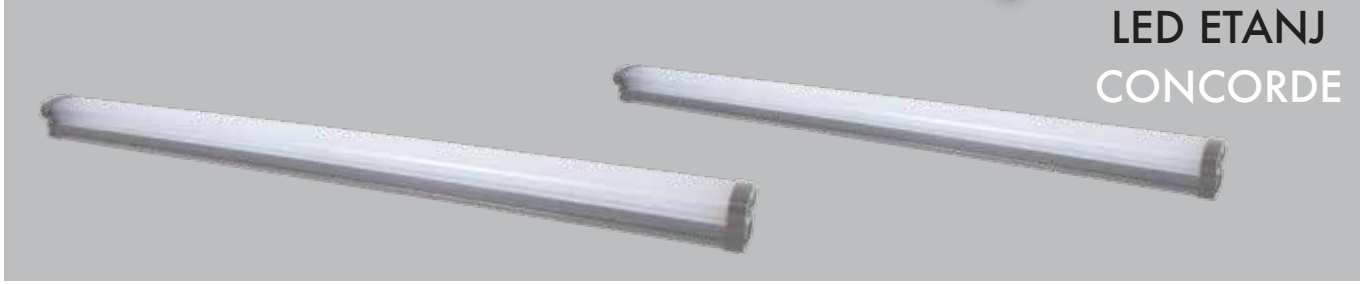

LED ETANJ CONCORDE

ÜRÜN AÇIKLAMASI:

POLİKARBON MALZEME, IP66 KORUMA SINIFI,
MONOBLOK GÖVDE, TAK ÇIKAR ÖZELLİKLİ, KOLAY MONTAJ,
LED ARMATÜR, 220V BESLEMELİ

KULLANIM ALANLARI:

OTOPARK, SUNDURMA, TRAFİKO ODASI, PANO ODASI, KONTEYNER,
AÇIK ALAN, KAZAN DAİRESİ, POMPA ODASI, KLİMA SANTRALLERİ



| KOD | AÇIKLAMA | BOYUT | LUMEN | GÜÇ | IŞIK SICAKLIĞI | AMBALAJ | FİYAT |
|----------------|------------------------------|--------|---------|-----|----------------|---------|------------|
| 016 039 106020 | Concord Led PC Etanj Armatür | 60 cm | 2640 lm | 20W | 6500K | 1ad. | 70,270 \$ |
| 016 039 112028 | Concord Led PC Etanj Armatür | 120 cm | 3520 lm | 28W | 6500K | 1ad. | 100,150 \$ |

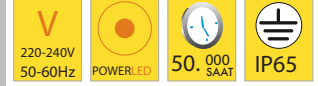

| KOD | AÇIKLAMA | BOYUT | LUMEN | GÜÇ | IŞIK SICAKLIĞI | AMBALAJ | FİYAT |
|----------------|---------------------|--------|---------|-----|----------------|---------|------------|
| 016 040 100001 | Wallwasher 12 Ledli | 35 cm | 900 lm | 12W | 3000K | 1ad. | 68,756 \$ |
| 016 040 100002 | Wallwasher 12 Ledli | 35 cm | 963 lm | 12W | 6500K | 1ad. | 68,756 \$ |
| 016 040 100003 | Wallwasher 18 Ledli | 50 cm | 1550 lm | 18W | 3000K | 1ad. | 94,294 \$ |
| 016 040 100004 | Wallwasher 18 Ledli | 50 cm | 1605 lm | 18W | 6500K | 1ad. | 94,294 \$ |
| 016 040 100005 | Wallwasher 36 Ledli | 100 cm | 3000 lm | 32W | 3000K | 1ad. | 152,245 \$ |
| 016 040 100006 | Wallwasher 36 Ledli | 100 cm | 3210 lm | 32W | 6500K | 1ad. | 152,245 \$ |

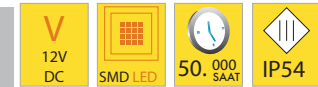

| KOD | AÇIKLAMA | BOYUT | GÜÇ | IŞIK SICAKLIĞI | AMBALAJ | FİYAT |
|----------------|-----------------------------|--------|-------|----------------|---------|-----------|
| 016 040 200001 | Led Bar (Led Trafosu Hariç) | 25 cm | 4W | 3500K | 1ad. | 7,170 \$ |
| 016 040 200002 | Led Bar (Led Trafosu Hariç) | 25 cm | 4W | 6000K | 1ad. | 7,170 \$ |
| 016 040 200003 | Led Bar (Led Trafosu Hariç) | 50 cm | 7,5W | 3500K | 1ad. | 12,425 \$ |
| 016 040 200004 | Led Bar (Led Trafosu Hariç) | 50 cm | 7,5W | 6000K | 1ad. | 12,425 \$ |
| 016 040 200005 | Led Bar (Led Trafosu Hariç) | 75 cm | 10,5W | 3500K | 1ad. | 19,841 \$ |
| 016 040 200006 | Led Bar (Led Trafosu Hariç) | 75 cm | 10,5W | 6000K | 1ad. | 19,841 \$ |
| 016 040 200007 | Led Bar (Led Trafosu Hariç) | 100 cm | 15W | 3500K | 1ad. | 21,707 \$ |
| 016 040 200008 | Led Bar (Led Trafosu Hariç) | 100 cm | 15W | 6000K | 1ad. | 21,707 \$ |

CANALEX

EKO SERISI

MEKS SERISI

AYDINLATMA

ERISI

LED PANELLER

MEKS PLUS

H-FREE SPILLARER

COMFORT SERISI

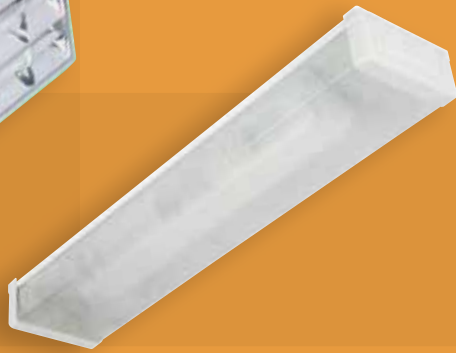



| Kod | Açıklama / Stok Cinsi | Amb. (Kutu/Bag) | Amb. (Koli/Çv.) | FİYAT |
|-----|-----------------------|--------------------|--------------------|-------|
|-----|-----------------------|--------------------|--------------------|-------|

T 8 S/Ü ÇİFTPARABOLİK ARMATÜRLER (MEKANİK BALANSTLI)

| | | | | |
|----------------|-----------------------------------|---|-----|---------|
| 090 039 171218 | 2X18 W S/Ü ÇİFT PARABOLİK ARMATÜR | 1 | ad. | 74,411 |
| 090 039 151418 | 4X18 W S/Ü ÇİFT PARABOLİK ARMATÜR | 1 | ad. | 125,011 |
| 090 039 171236 | 2X36 W S/Ü ÇİFT PARABOLİK ARMATÜR | 1 | ad. | 125,011 |

T 8 S/A ÇİFTPARABOLİK ARMATÜRLER (MEKANİK BALANSTLI)

| | | | | |
|----------------|-----------------------------------|---|-----|---------|
| 090 039 161218 | 2X18 W S/A ÇİFT PARABOLİK ARMATÜR | 1 | ad. | 74,411 |
| 090 039 141418 | 4X18 W S/A ÇİFT PARABOLİK ARMATÜR | 1 | ad. | 125,011 |
| 090 039 161236 | 2X36 W S/A ÇİFT PARABOLİK ARMATÜR | 1 | ad. | 125,011 |



T 8 S/Ü PRİZMATİK ARMATÜRLER (MEKANİK BALANSTLI)

| | | | | |
|----------------|------------------------------|---|-----|---------|
| 090 039 172218 | 2X18 W S/Ü PRİZMATİK ARMATÜR | 1 | ad. | 92,271 |
| 090 039 152418 | 4X18 W S/Ü PRİZMATİK ARMATÜR | 1 | ad. | 154,776 |
| 090 039 172236 | 2X36 W S/Ü PRİZMATİK ARMATÜR | 1 | ad. | 154,776 |

T 8 S/A PRİZMATİK ARMATÜRLER (MEKANİK BALANSTLI)

| | | | | |
|----------------|------------------------------|---|-----|---------|
| 090 039 162218 | 2X18 W S/A PRİZMATİK ARMATÜR | 1 | ad. | 92,271 |
| 090 039 142418 | 4X18 W S/A PRİZMATİK ARMATÜR | 1 | ad. | 154,776 |
| 090 039 162236 | 2X36 W S/A PRİZMATİK ARMATÜR | 1 | ad. | 154,776 |

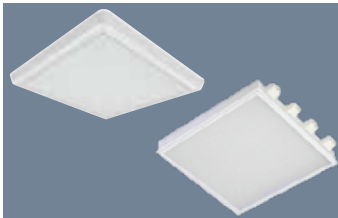

T 8 S/Ü OPAL ARMATÜRLER (MEKANİK BALANSTLI)

| | | | | |
|----------------|-------------------------|---|-----|---------|
| 090 039 170218 | 2X18 W S/Ü OPAL ARMATÜR | 1 | ad. | 102,688 |
| 090 039 150418 | 4X18 W S/Ü OPAL ARMATÜR | 1 | ad. | 171,147 |
| 090 039 170236 | 2X36 W S/Ü OPAL ARMATÜR | 1 | ad. | 171,147 |

T 8 S/A OPAL ARMATÜRLER (MEKANİK BALANSTLI)

| | | | | |
|----------------|-------------------------|---|-----|---------|
| 090 039 160218 | 2X18 W S/A OPAL ARMATÜR | 1 | ad. | 102,688 |
| 090 039 140418 | 4X18 W S/A OPAL ARMATÜR | 1 | ad. | 171,147 |
| 090 039 160236 | 2X36 W S/A OPAL ARMATÜR | 1 | ad. | 171,147 |

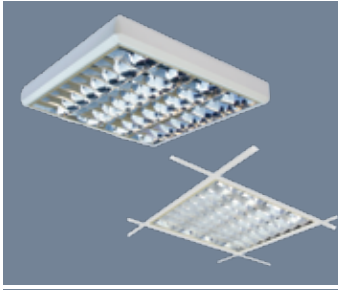

T 8 S/Ü ÇİFTPARABOLİK ARMATÜRLER (ELEKTRONİK BALANSTLI)

| | | | | |
|----------------|--|---|-----|---------|
| 090 038 000118 | TIL-118-SM S/Ü 1X18 ÇİFTPARABOLİK ARMATÜR (ELEKTRONİK BALANSTLI) | 1 | ad. | 92,270 |
| 090 038 000218 | TIL-218-SM S/Ü 2X18 ÇİFTPARABOLİK ARMATÜR (ELEKTRONİK BALANSTLI) | 1 | ad. | 101,199 |
| 090 038 000418 | TIL-418-SM S/Ü 4X18 ÇİFTPARABOLİK ARMATÜR (ELEKTRONİK BALANSTLI) | 1 | ad. | 139,893 |
| 090 038 000136 | TIL-136-SM S/Ü 1X36 ÇİFTPARABOLİK ARMATÜR (ELEKTRONİK BALANSTLI) | 1 | ad. | 110,128 |
| 090 038 000236 | TIL-236-SM S/Ü 2X36 ÇİFTPARABOLİK ARMATÜR (ELEKTRONİK BALANSTLI) | 1 | ad. | 139,893 |

T 8 S/A ÇİFTPARABOLİK ARMATÜRLER (ELEKTRONİK BALANSTLI)

| | | | | |
|----------------|--|---|-----|---------|
| 090 038 100118 | TIL-118-RM S/A 1X18 ÇİFTPARABOLİK ARMATÜR (ELEKTRONİK BALANSTLI) | 1 | ad. | 92,270 |
| 090 038 100218 | TIL-218-RM S/A 2X18 ÇİFTPARABOLİK ARMATÜR (ELEKTRONİK BALANSTLI) | 1 | ad. | 101,199 |
| 090 038 100418 | TIL-418-RM S/A 4X18 ÇİFTPARABOLİK ARMATÜR (ELEKTRONİK BALANSTLI) | 1 | ad. | 139,893 |
| 090 038 100136 | TIL-136-RM S/A 1X36 ÇİFTPARABOLİK ARMATÜR (ELEKTRONİK BALANSTLI) | 1 | ad. | 110,128 |
| 090 038 100236 | TIL-236-RM S/A 2X36 ÇİFTPARABOLİK ARMATÜR (ELEKTRONİK BALANSTLI) | 1 | ad. | 139,893 |

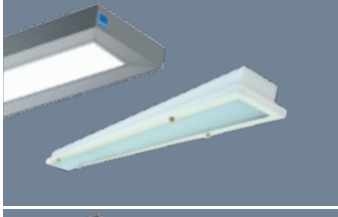

T 8 S/Ü PRİZMATİK ARMATÜRLER (ELEKTRONİK BALANSTLI)

| | | | | |
|----------------|---|---|-----|---------|
| 090 038 200218 | TIDA-218-SM S/Ü 2X18 PRİZMATİK ARMATÜR (ELEKTRONİK BALANSTLI) | 1 | ad. | 122,034 |
| 090 038 200418 | TIDA-418-SM S/Ü 4X18 PRİZMATİK ARMATÜR (ELEKTRONİK BALANSTLI) | 1 | ad. | 166,681 |
| 090 038 200236 | TIDA-236-SM S/Ü 2X36 PRİZMATİK ARMATÜR (ELEKTRONİK BALANSTLI) | 1 | ad. | 166,681 |

T 8 S/A PRİZMATİK ARMATÜRLER (ELEKTRONİK BALANSTLI)

| | | | | |
|----------------|---|---|-----|---------|
| 090 038 300218 | TIDA-218-RM S/A 2X18 PRİZMATİK ARMATÜR (ELEKTRONİK BALANSTLI) | 1 | ad. | 122,034 |
| 090 038 300418 | TIDA-418-RM S/A 4X18 PRİZMATİK ARMATÜR (ELEKTRONİK BALANSTLI) | 1 | ad. | 166,681 |
| 090 038 300236 | TIDA-236-RM S/A 2X36 PRİZMATİK ARMATÜR (ELEKTRONİK BALANSTLI) | 1 | ad. | 166,681 |

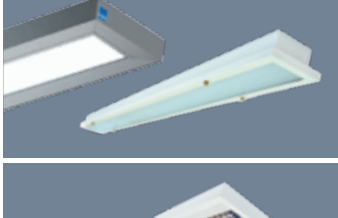

T 8 S/Ü OPAL ARMATÜRLER (ELEKTRONİK BALANSTLI)

| | | | | |
|----------------|--|---|-----|---------|
| 090 038 400418 | TIDA-418-SM S/Ü 4X18 OPAL ARMATÜR (ELEKTRONİK BALANSTLI) | 1 | ad. | 181,563 |
| 090 038 400236 | TIDA-236-SM S/Ü 2X36 OPAL ARMATÜR (ELEKTRONİK BALANSTLI) | 1 | ad. | 181,563 |

T 8 S/A OPAL ARMATÜRLER (ELEKTRONİK BALANSTLI)

| | | | | |
|----------------|--|---|-----|---------|
| 090 038 500418 | TIDA-418-RM S/A 4X18 OPAL ARMATÜR (ELEKTRONİK BALANSTLI) | 1 | ad. | 181,563 |
| 090 038 500236 | TIDA-236-RM S/A 2X36 OPAL ARMATÜR (ELEKTRONİK BALANSTLI) | 1 | ad. | 181,563 |

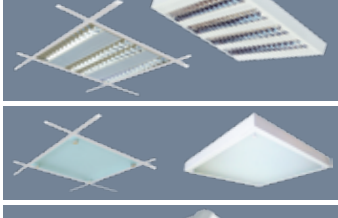

T 5 S/Ü ÇİFTPARABOLİK ARMATÜRLER (ELEKTRONİK BALANSTLI)

| | | | | |
|----------------|--|---|-----|---------|
| 090 038 600214 | TIL-214-SM S/Ü 2X14 ÇİFTPARABOLİK ARMATÜR (ELEKTRONİK BALANSTLI) | 1 | ad. | 148,822 |
| 090 038 600414 | TIL-414-SM S/Ü 4X14 ÇİFTPARABOLİK ARMATÜR (ELEKTRONİK BALANSTLI) | 1 | ad. | 181,563 |

T 5 S/A ÇİFTPARABOLİK ARMATÜRLER (ELEKTRONİK BALANSTLI)

| | | | | |
|----------------|--|---|-----|---------|
| 090 038 700214 | TIL-214-RM S/A 2X14 ÇİFTPARABOLİK ARMATÜR (ELEKTRONİK BALANSTLI) | 1 | ad. | 148,822 |
| 090 038 700414 | TIL-414-RM S/A 4X14 ÇİFTPARABOLİK ARMATÜR (ELEKTRONİK BALANSTLI) | 1 | ad. | 181,563 |



S/Ü-S/A DECORATİF TEMPERLİ CAM ARMATÜRLER (ELEKTRONİK BALANSTLI)

| | | | | |
|----------------|--|---|-----|---------|
| 090 038 140414 | TIGS-414-SM S/Ü 4X14 TEMPERLİ CAM ARMATÜR (ELEKTRONİK BALANSTLI) | 1 | ad. | 267,882 |
| 090 038 110414 | TIGS-414-RM S/A 4X14 TEMPERLİ CAM ARMATÜR (ELEKTRONİK BALANSTLI) | 1 | ad. | 267,882 |

AKRİLİK CAM ARMATÜRLER (ELEKTRONİK BALANSTLI)

| | | | | |
|----------------|--|---|-----|---------|
| 090 038 130136 | TLL-136 1X36 IP 44 AKRİLİK CAM ARMATÜR | 1 | ad. | 150,014 |
|----------------|--|---|-----|---------|

| Kod | Açıklama / Stok Cinsi | Amb. (Kutu/Bag) | Amb. (Kali/Çvl.) | FİYAT |
|--|--|--------------------|---------------------|-----------|
| ETANJ ARMATÜRLER AKRİLİK CAM-PC GÖVDE (MEKANİK BALANSTLI) | | | | |
| 066 038 910118 | T-2000-04 1X18 ETANJ ARMATÜR(AKRİLİK CAM)(MEKANİK BALANS) | 2 ad. | 12 | 53,576 |
| 066 038 910218 | T-2000-03 2X18 ETANJ ARMATÜR (AKRİLİK CAM)(MEKANİK BALANS) | 2 ad. | 12 | 62,506 |
| 066 038 910136 | T-2000-02 1X36 ETANJ ARMATÜR (AKRİLİK CAM)(MEKANİK BALANS) | 2 ad. | 12 | 75,305 |
| 066 038 910236 | T-2000-01 2X36 ETANJ ARMATÜR (AKRİLİK CAM)(MEKANİK BALANS) | 2 ad. | 12 | 95,247 |
| ETANJ ARMATÜRLER AKRİLİK CAM-PC GÖVDE (ELEKTRONİK BALANSTLI) | | | | |
| 090 038 190136 | 1X36 ETANJ ARMATÜR (ELEKTRONİK BALANSTLI) | 2 ad. | 12 | 81,852 |
| 090 038 190236 | 2X36 ETANJ ARMATÜR ELEKTRONİK BALANSTLI) | 2 ad. | 12 | 84,429 |
| ETANJ ARMATÜRLER PC CAM-PC GÖVDE (MEKANİK BALANSTLI) | | | | |
| 090 038 210118 | 1X18 W ETANJ ARMATÜR PC(MEKANİK BALANSTLI) | 2 ad. | 12 | 56,552 |
| 090 038 210136 | 1X36 W ETANJ ARMATÜR PC(MEKANİK BALANSTLI) | 2 ad. | 12 | 81,852 |
| 090 038 210218 | 2X18 W ETANJ ARMATÜR PC(MEKANİK BALANSTLI) | 2 ad. | 12 | 66,970 |
| 090 038 210236 | 2X36 W ETANJ ARMATÜR PC(MEKANİK BALANSTLI) | 2 ad. | 12 | 104,175 |
| ETANJ ARMATÜRLER PC CAM-PC GÖVDE (ELEKTRONİK BALANSTLI) | | | | |
| 090 038 120118 | TIBA-118 1X18 IP 65 ETANJ ARMATÜR (ELEKTRONİK BALANSTLI) | 2 ad. | 12 | 62,505 |
| 090 038 120218 | TIBA-218 2X18 IP 65 ETANJ ARMATÜR (ELEKTRONİK BALANSTLI) | 2 ad. | 12 | 71,029 |
| 090 038 120136 | TIBA-136 1X36 IP 65 ETANJ ARMATÜR (ELEKTRONİK BALANSTLI) | 2 ad. | 12 | 86,317 |
| 090 038 120236 | TIBA-236 2X36 IP 65 ETANJ ARMATÜR (ELEKTRONİK BALANSTLI) | 2 ad. | 12 | 92,270 |
| ETANJ ARMATÜRLER PC CAM-PC GÖVDE (OSRAM ELEKTRONİK BALANSTLI) | | | | |
| 090 038 220118 | 1X18 W ETANJ ARMATÜR PC (OSRAM ELEKTRONİK BALANSTLI) | 2 ad. | 12 | 80,364 |
| 090 038 220136 | 1X36 W ETANJ ARMATÜR PC (OSRAM ELEKTRONİK BALANSTLI) | 2 ad. | 12 | 107,152 |
| 090 038 220218 | 2X18 W ETANJ ARMATÜR PC (OSRAM ELEKTRONİK BALANSTLI) | 2 ad. | 12 | 97,330 |
| 090 038 220236 | 2X36 W ETANJ ARMATÜR PC (OSRAM ELEKTRONİK BALANSTLI) | 2 ad. | 12 | 125,011 |
| ETANJ ARMATÜRLER AKRİLİK CAM-ABS GÖVDE (MEKANİK BALANSTLI) | | | | |
| 066 038 200118 | 1X18 ETANJ ARMATÜR (AKRİLİK CAM-ABS GÖVDE)(MEKANİK BALANS) | 1 ad. | 6 | 49,111 |
| 066 038 200218 | 2X18 ETANJ ARMATÜR (AKRİLİK CAM-ABS GÖVDE)(MEKANİK BALANS) | 1 ad. | 6 | 58,041 |
| 066 038 200136 | 1X36 ETANJ ARMATÜR (AKRİLİK CAM-ABS GÖVDE)(MEKANİK BALANS) | 1 ad. | 6 | 63,993 |
| 066 038 200236 | 2X36 ETANJ ARMATÜR (AKRİLİK CAM-ABS GÖVDE)(MEKANİK BALANS) | 1 ad. | 6 | 68,458 |
| BATTEN TSC OKUL TİPİ ARMATÜRLER (MEKANİK BALANSTLI) | | | | |
| 078 038 050118 | 1x18 W BATTEN TSC OKUL TİPİ ARMATÜR (MEKANİK BALANSTLI) | 1 ad. | 6 | 64,380 |
| 078 038 050136 | 1x36 W BATTEN TSC OKUL TİPİ ARMATÜR (MEKANİK BALANSTLI) | 1 ad. | 6 | 75,631 |
| 078 038 050218 | 2x18 W BATTEN TSC OKUL TİPİ ARMATÜR (MEKANİK BALANSTLI) | 1 ad. | 6 | 95,246 |
| 078 038 050236 | 2x36 W BATTEN TSC OKUL TİPİ ARMATÜR (MEKANİK BALANSTLI) | 1 ad. | 6 | 115,188 |
| BATTEN TSC OKUL TİPİ ARMATÜRLER (OSRAM ELEKTRONİK BALANSTLI) | | | | |
| 078 040 050118 | 1x18 W BATTEN TSC OKUL TİPİ ARMATÜR (OSRAM ELEKTRONİK BALANSTLI) | 1 ad. | 6 | 110,009 |
| 078 040 050136 | 1x36 W BATTEN TSC OKUL TİPİ ARMATÜR (OSRAM ELEKTRONİK BALANSTLI) | 1 ad. | 6 | 120,308 |
| 078 040 050218 | 2x18 W BATTEN TSC OKUL TİPİ ARMATÜR (OSRAM ELEKTRONİK BALANSTLI) | 1 ad. | 6 | 139,059 |
| 078 040 050236 | 2x36 W BATTEN TSC OKUL TİPİ ARMATÜR (OSRAM ELEKTRONİK BALANSTLI) | 1 ad. | 6 | 160,013 |
| BATTEN TMS BANT TİPİ T8 LAMBALI ARMATÜR (MEKANİK BALANSTLI) | | | | |
| 078 038 900118 | 1x18 W BATTEN TMS BANT TİPİ T8 LAMBALI ARMATÜR (MEKANİK BALANSTLI) | 1 ad. | 6 | 27,979 |
| 078 038 900136 | 1x36 W BATTEN TMS BANT TİPİ T8 LAMBALI ARMATÜR (MEKANİK BALANSTLI) | 1 ad. | 6 | 33,575 |
| 078 038 900218 | 2x18 W BATTEN TMS BANT TİPİ T8 LAMBALI ARMATÜR (MEKANİK BALANSTLI) | 1 ad. | 6 | 33,575 |
| 078 038 900236 | 2x36 W BATTEN TMS BANT TİPİ T8 LAMBALI ARMATÜR (MEKANİK BALANSTLI) | 1 ad. | 6 | 51,255 |
| YÜKSEK TAVAN AYDINLATMA ARMATÜRLERİ | | | | |
| 090 039 400228 | 2X28W YÜKSEK TAVAN TL5 ARMATÜR | 1 | ad. | 277,015 |
| 090 039 400428 | 4X28W YÜKSEK TAVAN TL5 ARMATÜR | 1 | ad. | 448,906 |
| 090 039 400254 | 2X54W YÜKSEK TAVAN TL5 ARMATÜR | 1 | ad. | 298,324 |
| 090 039 400454 | 4X54W YÜKSEK TAVAN TL5 ARMATÜR | 1 | ad. | 483,000 |
| 090 039 400235 | 2X35W YÜKSEK TAVAN TL5 ARMATÜR | 1 | ad. | 349,465 |
| 090 039 400435 | 4X35W YÜKSEK TAVAN TL5 ARMATÜR | 1 | ad. | 568,235 |
| 090 039 400280 | 2X80W YÜKSEK TAVAN TL5 ARMATÜR | 1 | ad. | 417,653 |
| 090 039 400480 | 4X80W YÜKSEK TAVAN TL5 ARMATÜR | 1 | ad. | 696,088 |
| İTHAL PROJEKTÖRLER | | | | |
| 888 038 273150 | 150 W PROJEKTÖR (NORMAL) | 1 | ad. | 9,673 \$ |
| 888 038 273500 | 500 W PROJEKTÖR (NORMAL) | 1 | ad. | 11,459 \$ |
| 888 038 273100 | 1000 W PROJEKTÖR (NORMAL) | 1 | ad. | 24,556 \$ |
| MUTLUSAN-S TİPİ POLYESTER CADDE ARMATÜRLERİ | | | | |
| 066 038 910001 | S-3 160W E27 DUYLU BOŞ CADDE ARMATÜRÜ (KARE GÖVDE) | 1 | ad. | 46,879 |
| 066 038 910004 | CADDE ARMATÜRÜ KONSOL BORUSU | 1 | ad. | 10,654 |



NEMLİYER ARMATÜR ÇEŞİTLERİ



ÜRÜN KODU
016 038 700500
ÜRÜN ADI
NEMLİYER ALÜMİNYUM
KFS. CAM ARM. (BEYAZ)
AMBALAJ ADET / KOLİ
1/20
FİYAT
30,449 TL



ÜRÜN KODU
016 038 700511
ÜRÜN ADI
NEMLİYER ALÜMİNYUM
KFS. CAM ARM. (SİYAH)
AMBALAJ ADET / KOLİ
1/20
FİYAT
30,449 TL



ÜRÜN KODU
016 038 411100
ÜRÜN ADI
AQUA KAFESLİ APLİK
(BEYAZ) IP54
AMBALAJ ADET / KOLİ
1/20
FİYAT
10,899 TL

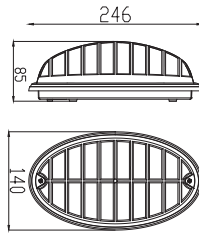

ÜRÜN KODU
016 038 411111
ÜRÜN ADI
AQUA KAFESLİ APLİK
(SİYAH) IP54
AMBALAJ ADET / KOLİ
1/20
FİYAT
10,899 TL



ÜRÜN KODU
016 038 411300
ÜRÜN ADI
OPAL KAFESLİ ARMATÜR
(BEYAZ) IP54
AMBALAJ ADET / KOLİ
1/24
FİYAT
10,899 TL

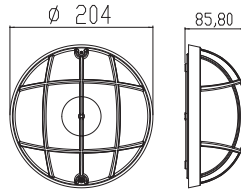

ÜRÜN KODU
016 038 411311
ÜRÜN ADI
OPAL KAFESLİ ARMATÜR
(SİYAH) IP54
AMBALAJ ADET / KOLİ
1/24
FİYAT
10,899 TL



ÜRÜN KODU
016 038 410600
ÜRÜN ADI
ELİPS OPAL ARMATÜR
(BEYAZ) IP65
AMBALAJ ADET / KOLİ
1/10
FİYAT
21,432 TL

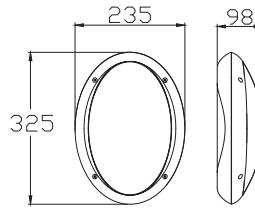

ÜRÜN KODU
016 038 410611
ÜRÜN ADI
ELİPS OPAL ARMATÜR
(SİYAH) IP65
AMBALAJ ADET / KOLİ
1/10
FİYAT
21,432 TL



ÜRÜN KODU
016 038 410500
ÜRÜN ADI
OPAL ARMATÜR
(BEYAZ) IP65
AMBALAJ ADET / KOLİ
1/10
FİYAT
21,432 TL

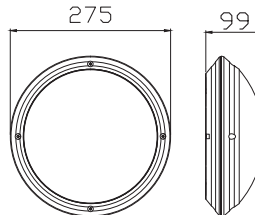

ÜRÜN KODU
016 038 410511
ÜRÜN ADI
OPAL ARMATÜR
(SİYAH) IP65
AMBALAJ ADET / KOLİ
1/10
FİYAT
21,432 TL



NEMLİYER ARMATÜR ÇEŞİTLERİ



ÜRÜN KODU
016 038 700100
ÜRÜN ADI
DOLUNAY OPAK ARMATÜR
(BEYAZ) IP54
AMBALAJ ADET / KOLİ
1/10
FİYAT
15,478 TL

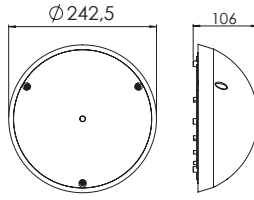

ÜRÜN KODU
016 038 700111
ÜRÜN ADI
DOLUNAY OPAK ARMATÜR
(SİYAH) IP54
AMBALAJ ADET / KOLİ
1/10
FİYAT
15,478 TL

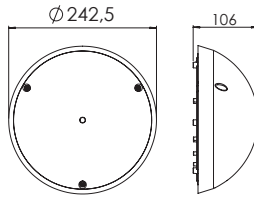

ÜRÜN KODU
016 038 700211
ÜRÜN ADI
DOLUNAY ŞEFFAF
ARMATÜR (SİYAH) IP54
AMBALAJ ADET / KOLİ
1/10
FİYAT
15,478 TL



ÜRÜN KODU
016 038 700300
ÜRÜN ADI
DOLUNAY OPAK APLİK
(BEYAZ) IP54
AMBALAJ ADET / KOLİ
1/20
FİYAT
15,478 TL

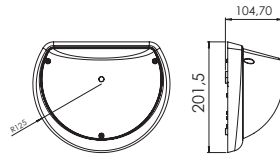

ÜRÜN KODU
016 038 700311
ÜRÜN ADI
DOLUNAY OPAK APLİK
(SİYAH) IP54
AMBALAJ ADET / KOLİ
1/20
FİYAT
15,478 TL



ÜRÜN KODU
016 038 700400
ÜRÜN ADI
DOLUNAY ŞEFFAF APLİK
(BEYAZ) IP54
AMBALAJ ADET / KOLİ
1/20
FİYAT
15,478 TL

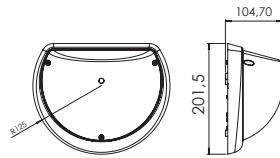

ÜRÜN KODU
016 038 700411
ÜRÜN ADI
DOLUNAY ŞEFFAF APLİK
(SİYAH) IP54
AMBALAJ ADET / KOLİ
1/20
FİYAT
15,478 TL



ÜRÜN KODU
016 038 410800
ÜRÜN ADI
OPAK ARMATÜR
(BEYAZ) IP54
AMBALAJ ADET / KOLİ
1/16
FİYAT
13,841 TL

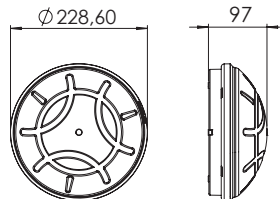

ÜRÜN KODU
016 038 410811
ÜRÜN ADI
OPAK ARMATÜR
(SİYAH) IP54
AMBALAJ ADET / KOLİ
1/16
FİYAT
13,841 TL



ARMATÜR ÇEŞİTLERİ



ÜRÜN KODU
016 038 270001
ÜRÜN ADI
LEDLİ OVAL KAFESLİ
ARMATÜR
AMBALAJ ADET / KOLİ
20
FİYAT
35,717 TL



ÜRÜN KODU
016 038 250028
ÜRÜN ADI
OVAL DÜZ
ARMATÜR
AMBALAJ ADET / KOLİ
48
FİYAT
8,697 TL



ÜRÜN KODU
016 038 250029
ÜRÜN ADI
OVAL KAFESLİ
ARMATÜR
AMBALAJ ADET / KOLİ
48
FİYAT
9,013 TL



ÜRÜN KODU
016 038 250030
ÜRÜN ADI
OVAL ŞAPKALI
ARMATÜR
AMBALAJ ADET / KOLİ
48
FİYAT
9,293 TL



ÜRÜN KODU
016 038 250040
ÜRÜN ADI
NEMLİYER OVAL KAFESLİ
ARMATÜR
AMBALAJ ADET / KOLİ
48
FİYAT
9,677 TL



ÜRÜN KODU
016 038 250039
ÜRÜN ADI
NEMLİYER OVAL DÜZ
ARMATÜR
AMBALAJ ADET / KOLİ
48
FİYAT
9,293 TL



ÜRÜN KODU
016 038 250049
ÜRÜN ADI
OVAL KAFESLİ ARMATÜR
SİYAH
AMBALAJ ADET / KOLİ
48
FİYAT
9,739 TL



ÜRÜN KODU
016 038 250041
ÜRÜN ADI
NEMLİYER OVAL ŞAPKALI
ARMATÜR
AMBALAJ ADET / KOLİ
48
FİYAT
10,072 TL



ARMATÜR ÇEŞİTLERİ

ÜRÜN KODU
016 038 130101 00 00
ÜRÜN ADI
BEGONYA NEMLİYER
TAVAN ARMATÜRÜ (DİKEY)
AMBALAJ ADET / KOLİ
12
FİYAT
16,339 TL

CE

Max: 60W

ÜRÜN KODU
016 038 501018
ÜRÜN ADI
POLİKARBON GÖVDE
KAFESLİ CAM ARMATÜR IP40
AMBALAJ ADET / KOLİ
2/20
FİYAT
21,431 TL

Max: 60W

ÜRÜN KODU
001 038 140101 00 00
ÜRÜN ADI
BEGONYA NEMLİYER
TAVAN ARMATÜRÜ (YATAY)
AMBALAJ ADET / KOLİ
12
FİYAT
16,812 TL

CE

Max: 60W

ÜRÜN KODU
016 038 500017
ÜRÜN ADI
POLİKARBON GÖVDE
KAFESİZ CAM ARMATÜR IP40
AMBALAJ ADET / KOLİ
2/20
FİYAT
19,049 TL

Max: 60W

ÜRÜN KODU
001 038 150101 00 00
ÜRÜN ADI
BEGONYA NEMLİYER
TAVAN ARMATÜRÜ (KLASİK)
AMBALAJ ADET / KOLİ
12
FİYAT
15,497 TL

CE

Max: 60W

ÜRÜN KODU
016 038 502018
ÜRÜN ADI
POLİKARBON GÖVDE TEL
KAFESLİ CAM ARM. IP 40
AMBALAJ ADET / KOLİ
2/20
FİYAT
33,336 TL

Max: 60W



ÜRÜN KODU
024 038 250019
ÜRÜN ADI
SARKIT ARMATÜR POLYKARBON
PORS. DUYLU 5 RENK
AMBALAJ ADET / KOLİ
5/30
FİYAT
8,159 TL

| Kod | Açıklama / Stok Cinsi | Amb. (Kutu) | Amb. Birimi | FİYAT |
|-----------------------------|---------------------------|-------------|-------------|--------|
| T-5 LEDLİ ARMATÜRLER | | | | |
| 102 038 518012 | CLAT 5-18 W (51 CM)(12V) | 1 | ad. | 43,158 |
| 102 038 518220 | CLAT 5-18 W (51 CM)(220V) | 1 | ad. | 50,599 |
| 102 038 513012 | CLAT 5-13 W (31 CM)(12V) | 1 | ad. | 32,741 |
| 102 038 513220 | CLAT 5-13 W (31 CM)(220V) | 1 | ad. | 37,950 |
| 102 038 510812 | CLAT 5-8 W (25 CM)(12V) | 1 | ad. | 31,253 |
| 102 038 508220 | CLAT 5-8 W (25 CM)(220V) | 1 | ad. | 34,973 |

| MUTLUSAN İTHAL ÜRÜNLERİMİZ | | | | |
|-----------------------------------|---|----|-----|---------|
| 888 038 000328 | L 328 LEDLİ KLASİK GECE LAMBASI AC 230V | 10 | ad. | 3,695\$ |
| 888 038 000368 | L 368 LEDLİ ÇOCUK GECE LAMBASI AC230V | 10 | ad. | 3,695\$ |
| 888 038 000378 | L 378 LEDLİ KELEBEK GECE LAMBASI AC230V | 10 | ad. | 3,653\$ |
| 888 038 000388 | L 388 LEDLİ ÇİÇEK GECE LAMBASI AC230V | 10 | ad. | 3,653\$ |



ARMATÜR ÇEŞİTLERİ



ÜRÜN KODU
001 038 250018 00 00
ÜRÜN ADI
HAZIR ASKI TİJ
TAKIMI
AMBALAJ ADET / KOLİ
25/500
FİYAT
1,783 TL



ÜRÜN KODU
001 038 010101 00 00
ÜRÜN ADI
MANOLYA TAVAN
ARMATÜRÜ
AMBALAJ ADET / KOLİ
5
FİYAT
12.894 TL

TS CE



ÜRÜN KODU
001 038 250016 00 00
ÜRÜN ADI
PAPATYA HAZIR ASKI
TİJ TAKIMI
AMBALAJ ADET / KOLİ
25/275
FİYAT
1,909 TL



ÜRÜN KODU
001 038 110101 00 00
ÜRÜN ADI
MERVE TAVAN
ARMATÜRÜ
AMBALAJ ADET / KOLİ
5
FİYAT
15.192 TL

TS CE



ÜRÜN KODU
001 038 250017 00 00
ÜRÜN ADI
BÜYÜK PAPATYA HAZIR
ASKI TİJ TAKIMI
AMBALAJ ADET / KOLİ
10/80
FİYAT
3,024 TL



ÜRÜN KODU
001 038 020101 00 00
ÜRÜN ADI
FULYA TAVAN
ARMATÜRÜ
AMBALAJ ADET / KOLİ
5
FİYAT
14.421 TL

TS CE



ÜRÜN KODU
016 038 250047
ÜRÜN ADI
ÇİFT DUYLU METALİZE
ARMATÜR
AMBALAJ ADET / KOLİ
10
FİYAT
24,067 TL



ÜRÜN KODU
001 038 180101 00 00
ÜRÜN ADI
AKASYA TAVAN
ARMATÜRÜ
AMBALAJ ADET / KOLİ
5
FİYAT
14.213 TL

TS CE



ÜRÜN KODU
016 038 250025
ÜRÜN ADI
32 W SİMİT ARMATÜR
(ELK.BALANSTLI)
AMBALAJ ADET / KOLİ
10
FİYAT
29,644 TL



ÜRÜN KODU
001 038 170101 00 00
ÜRÜN ADI
KAMELYA TAVAN
ARMATÜRÜ
AMBALAJ ADET / KOLİ
5
FİYAT
19.618 TL

TS CE



ÜRÜN KODU
078 039 100006
ÜRÜN ADI
ÇİFT DUYLU TAVAN
ARMATÜR
AMBALAJ ADET / KOLİ
2/32
FİYAT
16,371 TL

CAM ARMATÜR ÇEŞİTLERİ



ÜRÜN KODU
079 039 140003
ÜRÜN ADI
DEKORATİF CAM ARMATÜR
ÇİFT DUYLU (BEYAZ)
AMBALAJ ADET / KOLİ
12
FİYAT
43,903 TL



ÜRÜN KODU
078 039 130002
ÜRÜN ADI
CAM ARMATÜR ÇİFT
DUYLU (BEYAZ)
AMBALAJ ADET / KOLİ
12
FİYAT
30,509 TL



ÜRÜN KODU
079 039 140002
ÜRÜN ADI
DEKORATİF CAM ARMATÜR
ÇİFT DUYLU (KROM)
AMBALAJ ADET / KOLİ
12
FİYAT
61,018 TL



ÜRÜN KODU
078 039 130001
ÜRÜN ADI
CAM ARMATÜR ÇİFT
DUYLU (KROM)
AMBALAJ ADET / KOLİ
12
FİYAT
37,950 TL



ÜRÜN KODU
079 039 140005
ÜRÜN ADI
CAM ARMATÜR
GÜNEŞ 30 Ø
AMBALAJ ADET / KOLİ
12
FİYAT
30,509 TL



ÜRÜN KODU
078 039 130130
ÜRÜN ADI
CAM ARMATÜR
MARTI 30 Ø
AMBALAJ ADET / KOLİ
12
FİYAT
30,509 TL



ÜRÜN KODU
079 039 140004
ÜRÜN ADI
CAM ARMATÜR
GÜNEŞ 25 Ø
AMBALAJ ADET / KOLİ
20
FİYAT
26,788 TL



ÜRÜN KODU
078 039 130125
ÜRÜN ADI
CAM ARMATÜR
MARTI 25 Ø
AMBALAJ ADET / KOLİ
12
FİYAT
26,788 TL



ÜRÜN KODU
079 039 140001
ÜRÜN ADI
YARIM AY CAM APLİK
GÜNEŞ
AMBALAJ ADET / KOLİ
20
FİYAT
26,044 TL



ÜRÜN KODU
078 039 130200
ÜRÜN ADI
YARIMAY CAM APLİK
MARTI
AMBALAJ ADET / KOLİ
20
FİYAT
26,044 TL



ARMATÜR ÇEŞİTLERİ



ÜRÜN KODU
001 038 250022 00 00
ÜRÜN ADI
360 DRC.SENSÖRLÜ TAVAN
ARAMTÜR (2X25 W)
AMBALAJ ADET / KOLİ
10
FİYAT
51,941 TL



ÜRÜN KODU
001 038 250025 00 00
ÜRÜN ADI
COMBO LEDLİ SENS.TAVAN
ARM. 2X25W (PİL DAHİL)
AMBALAJ ADET / KOLİ
10
FİYAT
108,640 TL



ÜRÜN KODU
001 038 250021 00 00
ÜRÜN ADI
360 DRC.SENSÖRLÜ TAVAN
ARMT.(2X25 W)(PİL DAHİL)
AMBALAJ ADET / KOLİ
10
FİYAT
83,660 TL



ÜRÜN KODU
016 038 250044
ÜRÜN ADI
SENSÖRLÜ 80 LEDLİ BEYAZ
ARMATÜR (PİL DAHİL)
AMBALAJ ADET / KOLİ
10
FİYAT
125,011 TL



ÜRÜN KODU
016 038 250061
ÜRÜN ADI
LEDLİ SENSÖRLÜ TAVAN
ARMATÜRÜ
AMBALAJ ADET / KOLİ
10
FİYAT
98,223 TL



ÜRÜN KODU
016 038 600080
ÜRÜN ADI
SENSÖRLÜ 80 LEDLİ KROM
ARMATÜR (PİL DAHİL)
AMBALAJ ADET / KOLİ
10
FİYAT
130,963 TL



ÜRÜN KODU
016 038 250060
ÜRÜN ADI
LEDLİ SENSÖRLÜ TAVAN
ARMATÜRÜ (PİL DAHİL)
AMBALAJ ADET / KOLİ
10
FİYAT
125,011 TL



ÜRÜN KODU
078 039 500100
ÜRÜN ADI
SENSÖRLÜ DUVAR APLİK
E-27 DUYLU
AMBALAJ ADET / KOLİ
20
FİYAT
44,647 TL



ÜRÜN KODU
016 038 250062
ÜRÜN ADI
LEDLİ CAMLI TAVAN
ARMATÜRÜ
AMBALAJ ADET / KOLİ
10
FİYAT
65,482 TL



ÜRÜN KODU
078 039 500110
ÜRÜN ADI
SENSÖRLÜ DUVAR APLİK
LEDLİ
AMBALAJ ADET / KOLİ
20
FİYAT
68,458 TL

ARMATÜR ÇEŞİTLERİ



ÜRÜN KODU
016 038 250031
ÜRÜN ADI
TAVAN GLOP ARMATÜRÜ
(MİNİ) 75W
AMBALAJ ADET / KOLİ
48
FİYAT
5,179 TL



ÜRÜN KODU
001 038 120101 00 00
ÜRÜN ADI
ORKİDE TAVAN
ARMATÜRÜ
AMBALAJ ADET / KOLİ
48
FİYAT
7.932 TL

TS CE



ÜRÜN KODU
016 038 250036
ÜRÜN ADI
TAVAN GLOP ARMATÜRÜ
(BÜYÜK) 75W
AMBALAJ ADET / KOLİ
24
FİYAT
7,458 TL



ÜRÜN KODU
001 038 160101 00 00
ÜRÜN ADI
YONCA TAVAN
ARMATÜRÜ
AMBALAJ ADET / KOLİ
16
FİYAT
8.236 TL

TS CE



ÜRÜN KODU
016 038 250043
ÜRÜN ADI
TAVAN GLOP ARMATÜR
(BÜYÜK MEGA)75W
AMBALAJ ADET / KOLİ
24
FİYAT
8,697 TL



ÜRÜN KODU
001 038 060101 00 00
ÜRÜN ADI
YASEMİN KÜRE TAVAN
ARMATÜRÜ
AMBALAJ ADET / KOLİ
12
FİYAT
10.644 TL

TS CE



ÜRÜN KODU
001 038 050101 00 00
ÜRÜN ADI
YASEMİN UFO KÜRE TAVAN
ARMATÜRÜ
AMBALAJ ADET / KOLİ
12
FİYAT
12.314 TL



ÜRÜN KODU
001 038 030101 00 00
ÜRÜN ADI
YASEMİN DÜZ TAVAN
ARMATÜRÜ
AMBALAJ ADET / KOLİ
12
FİYAT
12.290 TL

TS CE



ÜRÜN KODU
001 038 070101 00 00
ÜRÜN ADI
YASEMİN UFO DÜZ TAVAN
ARMATÜRÜ
AMBALAJ ADET / KOLİ
12
FİYAT
12.064 TL



ÜRÜN KODU
001 038 040101 00 00
ÜRÜN ADI
YASEMİN UFO TAVAN
ARMATÜRÜ
AMBALAJ ADET / KOLİ
12
FİYAT
13.076 TL

TS CE

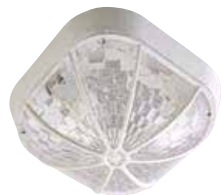

ÜRÜN KODU
016 038 250015
ÜRÜN ADI
KARE TAVAN GLOP
ARMATÜRÜ (KAFESLİ)
AMBALAJ ADET / KOLİ
24
FİYAT
8,417 TL



ÜRÜN KODU
016 038 250034
ÜRÜN ADI
TAVAN GLOP ARMATÜRÜ
(MAXİ KAFESLİ) 75W
AMBALAJ ADET / KOLİ
24
FİYAT
11,474 TL



Max: 60W



Max: 60W

ARMATÜR ÇEŞİTLERİ



ÜRÜN KODU
016 038 250032
ÜRÜN ADI
TAVAN GLOP ARMATÜRÜ
(MİDİ) 75W
AMBALAJ ADET / KOLİ
24
FİYAT
9,370 TL



ÜRÜN KODU
016 038 250033
ÜRÜN ADI
TAVAN GLOP ARMATÜRÜ
(MAXİ) 75W
AMBALAJ ADET / KOLİ
24
FİYAT
10,138 TL



ÜRÜN KODU
016 038 250014
ÜRÜN ADI
KARE TAVAN GLOP
ARMATÜRÜ
AMBALAJ ADET / KOLİ
24
FİYAT
7,268 TL



CE

ÜRÜN KODU
001 038 020201 00 00
ÜRÜN ADI
FULYA DUVAR APLİK
AMBALAJ ADET / KOLİ
20
FİYAT
8,444 TL



ÜRÜN KODU
016 038 250013
ÜRÜN ADI
DUVAR APLİK
(KRALİÇE)
AMBALAJ ADET / KOLİ
4/48
FİYAT
8,224 TL



CE

ÜRÜN KODU
001 038 010201 00 00
ÜRÜN ADI
MANOLYA DUVAR
APLİK
AMBALAJ ADET / KOLİ
20
FİYAT
9,218 TL



ÜRÜN KODU
078 039 100005
ÜRÜN ADI
NERGİS APLİK
AMBALAJ ADET / KOLİ
8/64
FİYAT
8,632 TL



CE

ÜRÜN KODU
001 038 090101 00 00
ÜRÜN ADI
YASEMİN DUVAR
APLİK
AMBALAJ ADET / KOLİ
24
FİYAT
10,819 TL



ÜRÜN KODU
016 038 250037
ÜRÜN ADI
DUVAR APLİK
(HİLAL)
AMBALAJ ADET / KOLİ
4/48
FİYAT
5,548 TL



CE

ÜRÜN KODU
001 038 080101 00 00
ÜRÜN ADI
YASEMİN OVAL
ARMATÜR
AMBALAJ ADET / KOLİ
24
FİYAT
10,965 TL



ÜRÜN KODU
016 038 250038
ÜRÜN ADI
DUVAR APLİK
(YELPAZE)
AMBALAJ ADET / KOLİ
4/48
FİYAT
8,035 TL



CE

ÜRÜN KODU
001 038 190201 00 00
ÜRÜN ADI
PİRAMİT APLİK
AMBALAJ ADET / KOLİ
24
FİYAT
11,037 TL

CANALEX

EKO SERISI

MEKS SERISI

FE

BAHÇE AYDINLATMA



ISI

LED PANELLER

MEKS PLUS

H. FREE SPILLARER

COMFORT SERISI

MUTLUSAN BAHÇE ARMATÜRÜ



ÜRÜN KODU
016 038 010116
ÜRÜN ADI
FLORA BAHÇE ARMATÜRÜ
(SİYAH)
AMBALAJ ADET / KOLİ
1/12
FİYAT
22,324 TL



ÜRÜN KODU
016 038 010117
ÜRÜN ADI
FLORA BAHÇE ARMATÜRÜ
(BEYAZ)
AMBALAJ ADET / KOLİ
1/12
FİYAT
22,324 TL



ÜRÜN KODU
016 038 020116
ÜRÜN ADI
FLORA BAHÇE ARMATÜRÜ
APLİK (SİYAH)
AMBALAJ ADET / KOLİ
1/12
FİYAT
22,324 TL



ÜRÜN KODU
016 038 020117
ÜRÜN ADI
FLORA BAHÇE ARMATÜRÜ
APLİK (BEYAZ)
AMBALAJ ADET / KOLİ
1/12
FİYAT
22,324 TL



ÜRÜN KODU
016 038 412000
ÜRÜN ADI
FLORA BAHÇE ARMATÜRÜ
TAVAN TİPİ (SİYAH)
AMBALAJ ADET / KOLİ
1/12
FİYAT
22,324 TL



ÜRÜN KODU
016 038 412011
ÜRÜN ADI
FLORA BAHÇE ARMATÜRÜ
TAVAN TİPİ (BEYAZ)
AMBALAJ ADET / KOLİ
1/12
FİYAT
22,324 TL



ÜRÜN KODU
016 038 412100
ÜRÜN ADI
FLORA BAHÇE ARMATÜRÜ
YARIM APLİK (SİYAH)
AMBALAJ ADET / KOLİ
1/20
FİYAT
11,846 TL



ÜRÜN KODU
016 038 412111
ÜRÜN ADI
FLORA BAHÇE ARMATÜRÜ
YARIM APLİK (BEYAZ)
AMBALAJ ADET / KOLİ
1/20
FİYAT
11,846 TL



DEKORATİF LED AMPUL

| Kod | | Fiyat |
|----------------|---|------------|
| 016 038 440001 | SAPLAMALI BAHÇE AYDINLATMA ARMATÜRÜ (IP 67) 7W 220V (MAVİ) | 163,706 \$ |
| 016 038 440002 | SAPLAMALI BAHÇE AYDINLATMA ARMATÜRÜ (IP 67) 7W 220V (YEŞİL) | 163,706 \$ |
| 016 038 440003 | SAPLAMALI BAHÇE AYDINLATMA ARMATÜRÜ (IP 67) 7W 220V (KIRMIZI) | 163,706 \$ |
| 016 038 440004 | SAPLAMALI BAHÇE AYDINLATMA ARMATÜRÜ (IP 67) 7W 220V (SICAK BEYAZ) | 163,706 \$ |
| 016 038 440005 | SAPLAMALI BAHÇE AYDINLATMA ARMATÜRÜ (IP 67) 7W 220V (DOĞAL BEYAZ) | 163,706 \$ |





Parklar, Bahçeler ve Kır Düğünlerinde **SU GEÇİRMEZ** Kurulumu Kolay Seyyar Aydınlatma Seti

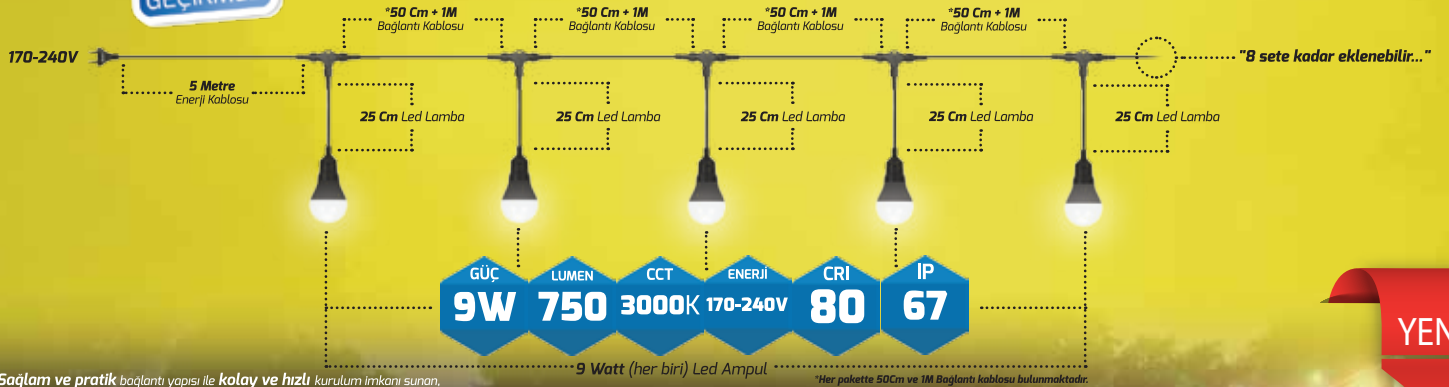

Sağlam ve pratik bağlantı yapısı ile **kolay ve hızlı** kurulum imkanı sunan,
Olumsuz dış koşullarına karşı son derece **dayanıklı**,
Özel tasarımı sayesinde **eklenebilir ve uzatılabilir** LED Lamba Seti.
Her türlü iç ve dış mekan aydınlatma uygulamaları için **ideal çözüm!**

YENİ



| KOD | AÇIKLAMA | LUMEN | GÜÇ | IŞIK SICAKLIĞI | AMBALAJ | FİYAT |
|----------------|---|--------|-----|----------------|---------|-----------|
| 010 093 100900 | 9W 5'Li Led Lamba Seti Dış Mekan (Su Geçirmez) (Park ve Bahçeler için Kurulumu Kolay Seyyar Aydınlatma Seti) | 750 lm | 9W | 3000K | 1Takım | 88,550 \$ |

9W



AKSESUARLAR

| | | | | | | |
|----------------|--|--------|----|-------|------|-----------|
| 010 093 100701 | 9W Led + Ara Kablo 25cm + Erkek Konnektör Takımı | 750 lm | 9W | 3000K | 1ad. | 11,020 \$ |
| 010 093 100000 | 1 Metre Ara Kablo İki Taraflı Konnektör Takılı | | | | 1ad. | 2,820 \$ |
| 010 093 100001 | T Bağlantı Adaptörü | | | | 1ad. | 2,811 \$ |
| 010 093 100005 | Power Kablo 5 MT 220V (Erkek Soketli) | | | | | 6,381 \$ |
| 010 093 100002 | Sonlandırma Tapası | | | | | 0,141 \$ |



GÜN
IŞIĞI

MAVİ

AMBER

YEŞİL

KIRMIZI

SICAK
BEYAZ



DEKORATİF LED AMPUL

| Kod | | Fiyat |
|----------------|---|----------|
| 010 093 100101 | DEKORATİF LED AMPUL 7W-220V (IP 67) YEŞİL | 8,443 \$ |
| 010 093 100102 | DEKORATİF LED AMPUL 7W-220V (IP 67) KIRMIZI | 8,443 \$ |
| 010 093 100103 | DEKORATİF LED AMPUL 7W-220V (IP 67) MAVİ | 8,443 \$ |
| 010 093 100104 | DEKORATİF LED AMPUL 7W-220V (IP 67) AMBER | 8,443 \$ |
| 010 093 100105 | DEKORATİF LED AMPUL 7W-220V (IP 67) SOĞUK BEYAZ | 8,443 \$ |
| 010 093 100106 | DEKORATİF LED AMPUL 7W-220V (IP 67) SICAK BEYAZ | 8,443 \$ |



RENKLİ DUY TAKIMI

| Kod | | Fiyat |
|----------------|----------------------------------|----------|
| 010 093 100120 | RENKLİ DUY TAKIM (AMPUL HARİÇ) | 7,028 \$ |
| 010 093 100121 | SIYAH DUY TAKIMI (AMPUL HARİÇ) | 6,269 \$ |



SU GEÇİRMEZ SAHA MONTAJ KONNEKTÖR ve REKORLARI

Enerjinin kolay dağıtımına yardımcı olan, pratik ve hızlı montaj imkanı sunan, her türlü olumsuz doğa koşullarına son derece dayanıklı, darbelere karşı mukavemetli, **IP68** standartlarına uygun **Saha Montaj Konnektör Rekorları**.



SAHA MONTAJ I KONNEKTÖR

ÜRÜN KODU
010 093 130416

AMBALAJ ADET / KOLİ
1/10 ad.

FİYAT
4,465 \$

TEKNİK ÖZELLİKLER

| | |
|----------------------|--------------------------|
| Kontakt Adedi | : 3 |
| Min. Kablo Dış Çapı | : 5,5mm |
| Maks. Kablo Dış Çapı | : 8,5mm |
| Çalışma Sıcaklığı | : -40°C ~ +105°C |
| IP Sınıfı | : IP68 (1m/30dak.) |
| Gövde Materyali | : PA6 |
| Terminal Materyali | : Piring - Nikel Kaplama |
| Conta Malzemesi | : Silikon |

IP68
(1m/30dak.)



SAHA MONTAJ T KONNEKTÖR

ÜRÜN KODU
010 093 130315

AMBALAJ ADET / KOLİ
1/10 ad.

FİYAT
7,739 \$

TEKNİK ÖZELLİKLER

| | |
|----------------------|--------------------------|
| Kontakt Adedi | : 3 |
| Min. Kablo Dış Çapı | : 5,5mm |
| Maks. Kablo Dış Çapı | : 8,5mm |
| Çalışma Sıcaklığı | : -40°C ~ +105°C |
| IP Sınıfı | : IP68 (1m/30dak.) |
| Gövde Materyali | : PA6 |
| Terminal Materyali | : Piring - Nikel Kaplama |
| Conta Malzemesi | : Silikon |

IP68
(1m/30dak.)



SAHA MONTAJ H KONNEKTÖR

ÜRÜN KODU
010 093 130415

AMBALAJ ADET / KOLİ
1/5 ad.

FİYAT
20,835 \$

TEKNİK ÖZELLİKLER

| | |
|----------------------|--------------------------|
| Kontakt Adedi | : 3 |
| Min. Kablo Dış Çapı | : 5,5mm |
| Maks. Kablo Dış Çapı | : 8,5mm |
| Çalışma Sıcaklığı | : -40°C ~ +105°C |
| IP Sınıfı | : IP55 |
| Gövde Materyali | : PA6 |
| Terminal Materyali | : Piring - Nikel Kaplama |
| Conta Malzemesi | : Silikon |



SAHA MONTAJ Y KONNEKTÖR

ÜRÜN KODU
010 093 130316

AMBALAJ ADET / KOLİ
1/10 ad.

FİYAT
14,882 \$

TEKNİK ÖZELLİKLER

| | |
|----------------------|--------------------------|
| Kontakt Adedi | : 3 |
| Min. Kablo Dış Çapı | : 5,5mm |
| Maks. Kablo Dış Çapı | : 8,5mm |
| Çalışma Sıcaklığı | : -40°C ~ +105°C |
| IP Sınıfı | : IP55 |
| Gövde Materyali | : PA6 |
| Terminal Materyali | : Piring - Nikel Kaplama |
| Conta Malzemesi | : Silikon |



SAHA MONTAJ PANEL KONNEKTÖR

ÜRÜN KODU
010 093 130200

AMBALAJ ADET / KOLİ
1/5 ad.

FİYAT
4,465 \$

TEKNİK ÖZELLİKLER

| | |
|----------------------|--------------------------|
| Kontakt Adedi | : 3 |
| Min. Kablo Dış Çapı | : 5,5mm |
| Maks. Kablo Dış Çapı | : 8,5mm |
| Çalışma Sıcaklığı | : -40°C ~ +105°C |
| IP Sınıfı | : IP68 (1m/30dak.) |
| Gövde Materyali | : PA6 |
| Terminal Materyali | : Piring - Nikel Kaplama |
| Conta Malzemesi | : Silikon |

IP68
(1m/30dak.)



SAHA MONTAJ DÜZ KONNEKTÖR

ÜRÜN KODU
010 093 130215

AMBALAJ ADET / KOLİ
1/5 ad.

FİYAT
5,358 \$

TEKNİK ÖZELLİKLER

| | |
|----------------------|--------------------------|
| Kontakt Adedi | : 3 |
| Min. Kablo Dış Çapı | : 5,5mm |
| Maks. Kablo Dış Çapı | : 8,5mm |
| Çalışma Sıcaklığı | : -40°C ~ +85°C |
| IP Sınıfı | : IP68 (60 min. 50m.) |
| Gövde Materyali | : PA6 |
| Terminal Materyali | : Piring - Nikel Kaplama |

IP68
(1m/30dak.)



1x3 Enerji Dağıtıcı

ÜRÜN KODU
010 093 130420

AMBALAJ ADET / KOLİ
1/10 ad.

FİYAT
23,812 \$

TEKNİK ÖZELLİKLER

| | |
|----------------------|--------------------------|
| Kontakt Adedi | : 3 |
| Min. Kablo Dış Çapı | : 5,5mm |
| Maks. Kablo Dış Çapı | : 8,5mm |
| Çalışma Sıcaklığı | : -40°C ~ +105°C |
| IP Sınıfı | : IP68 (1m/30dak.) |
| Gövde Materyali | : PA6 |
| Terminal Materyali | : Piring - Nikel Kaplama |
| Conta Malzemesi | : Silikon |

IP68
(1m/30dak.)



1x5 Enerji Dağıtıcı

ÜRÜN KODU
010 093 130617

AMBALAJ ADET / KOLİ
1/5 ad.

FİYAT
35,718 \$

TEKNİK ÖZELLİKLER

| | |
|----------------------|--------------------------|
| Kontakt Adedi | : 3 |
| Min. Kablo Dış Çapı | : 5,5mm |
| Maks. Kablo Dış Çapı | : 8,5mm |
| Çalışma Sıcaklığı | : -40°C ~ +105°C |
| IP Sınıfı | : IP68 (1m/30dak.) |
| Gövde Materyali | : PA6 |
| Terminal Materyali | : Piring - Nikel Kaplama |
| Conta Malzemesi | : Silikon |

IP68
(1m/30dak.)

LED

ACİL AYDINLATMA ARMATÜRLERİ



CANALEX

EKO SERISI

MEKS SERISI

FE

ISI

LED PANELLER

MEKS PLUS

H. FREE SPILLARER

COMFORT SERISI

EXIT - ŞEFFAF ACİL AYDINLATMA ARMATÜRLERİ (LEDLİ)



| | | | | | | |
|--|--|--|--|--|--|--|
| | | | | | | |
| 102 038 000801 CEXA-8-01 73,652 TL | 102 038 000802 CEXA-8-02 73,652 TL | 102 038 000803 CEXA-8-03 73,652 TL | 102 038 000804 CEXA-8-04 73,652 TL | 102 038 000805 CEXA-8-05 73,652 TL | 102 038 000806 CEXA-8-06 73,652 TL | 102 038 000807 CEXA-8-07 73,652 TL |
| | | | | | | |
| 102 038 000808 CEXA-8-08 73,652 TL | 102 038 000809 CEXA-8-09 73,652 TL | 102 038 000810 CEXA-8-10 73,652 TL | 102 038 000811 CEXA-8-11 73,652 TL | 102 038 000812 CEXA-8-12 73,652 TL | 102 038 000813 CEXA-8-13 73,652 TL | 102 038 000814 CEXA-8-14 73,652 TL |
| | | | | | | |
| 102 038 000815 CEXA-8-15 73,652 TL | 102 038 000816 CEXA-8-16 73,652 TL | 102 038 000817 CEXA-8-17 73,652 TL | 102 038 000818 CEXA-8-18 73,652 TL | 102 038 000819 CEXA-8-19 73,652 TL | 102 038 000820 CEXA-8-20 73,652 TL | 102 038 000821 CEXA-8-21 73,652 TL |
| | | | | | | |
| 102 038 000822 CEXA-8-22 73,652 TL | 102 038 000823 CEXA-8-23 73,652 TL | 102 038 000824 CEXA-8-24 73,652 TL | 102 038 000825 CEXA-8-25 73,652 TL | 102 038 000826 CEXA-8-26 73,652 TL | 102 038 000827 CEXA-8-27 73,652 TL | |

FOSFORLU SERİ ACİL AYDINLATMA ARMATÜRÜ

| | | | | | |
|--|--|--|--|--|--|
| | | | | | |
| 102 038 000901 CEXA-FS 1 47,624 TL | 102 038 000902 CEXA-FS 2 47,624 TL | 102 038 000903 CEXA-FS 3 47,624 TL | 102 038 000904 CEXA-FS 4 47,624 TL | 102 038 000905 CEXA-FS 5 47,624 TL | 102 038 000906 CEXA-FS 6 47,624 TL |

ÇİFT YÜZLÜ YÖN TAVAN SERİSİ LEDLİ ACİL DURUM ARMATÜRLERİ

ÇİFT YÜZLÜ YÖN TAVAN SERİSİ LEDLİ ACİL DURUM ARMATÜRLERİ



Dekoratif ABS gövde
Acilde veya sürekli çalışma
1 veya 3 saat yanma süresi
NI-CD Uzun ömürlü batarya
Pleksiglas üzeri gravür veya UV uygulama
Adetli alımlarda farklı renk seçenekleri
Ultra parlak ledler
Aşırı şarj ve deşarj karşı koruma
Şarj olma süresi 24 saat

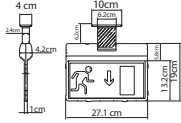

112 038 1000-XX
84,085 TL

ÇİFT YÜZLÜ YÖN DUVAR SERİSİ LEDLİ ACİL DURUM ARMATÜRLERİ



Dekoratif ABS gövde
Acilde veya sürekli çalışma
1 veya 3 saat yanma süresi
NI-CD Uzun ömürlü batarya
Pleksiglas üzeri gravür veya UV uygulama
Adetli alımlarda farklı renk seçenekleri
Ultra parlak ledler
Aşırı şarj ve deşarj karşı koruma
Şarj olma süresi 24 saat

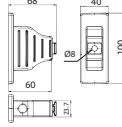

112 038 2000-XX
90,037 TL

BİLGİ SERİSİ LEDLİ ACİL DURUM ARMATÜRLERİ



Acilde 1 veya 3 saat seçeneği
NI-CD Uzun ömürlü batarya
Sürekli veya acilde yanma imkanı
340x90x48 mm ölçülerinde
Akrilik üzeri folyo veya UV boyama
Şarj olma süresi 24 Saat



112 038 4000-XX
76,852 TL

ÇİFT YÜZLÜ SIVA ALTI SERİSİ LEDLİ ACİL DURUM ARMATÜRLERİ



Kombine bir modeldir,
Hem aydınlatma hem de yönlendirmeyi sağlar.
Dekoratif ABS gövde
Acilde veya sürekli çalışma
1 veya 3 saat yanma süresi
NI-CD Uzun ömürlü batarya
Pleksiglas üzeri gravür uygulama
Tavana siva altı uygulama
Ultra parlak ledler
Aşırı şarj ve deşarj karşı koruma
Şarj olma süresi 24 saat

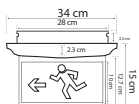

112 038 6000-XX
187,101 TL

ÇİFT YÜZLÜ SIVA ÜSTÜ SERİSİ LEDLİ ACİL DURUM ARMATÜRLERİ



Kombine bir modeldir,
Hem aydınlatma hem de yönlendirmeyi sağlar.
Dekoratif ABS gövde
Acilde veya sürekli çalışma
1 veya 3 saat yanma süresi
NI-CD Uzun ömürlü batarya
Pleksiglas üzeri gravür uygulama
Tavana siva üstü uygulama
Ultra parlak ledler
Aşırı şarj ve deşarj karşı koruma
Şarj olma süresi 24 saat



112 038 5000-XX
180,285 TL

SEMBOLE KOD TABLOSU

| | | | | | |
|----|-------|----|---------------|----|------------|
| 01 | ÇIKIŞ | 02 | EXIT | 03 | |
| 04 | | 05 | | 06 | |
| 07 | | 08 | | 09 | |
| 10 | | 11 | | 12 | |
| 13 | | 14 | | 15 | |
| 16 | خروج | 17 | ÇIKIŞ EXIT | 18 | ACİL ÇIKIŞ |

Standart sembol seçenekleri dışında istenilen sembol uygulanabilir.

Sipariş Verdiğiniz Ürünün Sembol Kodunu Yazmayı Unutmayınız.

Ürün Kodunun Son 2 hanesi olan XX Rakamları Ürünün Sembol Kodunu belirtmektedir.

LEDLİ ACİL AYDINLATMA ARMATÜRLERİ



17,34,51 led seçenekleri ile
Acilde veya sürekli çalışma
1 veya 3 saat yanma süresi
NI-CD Uzun ömürlü batarya
Dekoratif ABS gövde
Tavana siva altı uygulama
Ultra parlak ledler
Aşırı şarj ve deşarj karşı koruma
Şarj olma süresi 24 saat
Besleme / Şarj / Hata gösterge ledleri
Dahili test butonu
Düşük bakım maliyeti

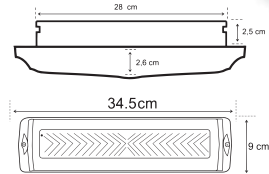
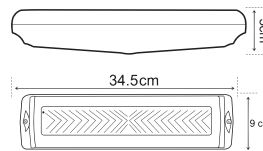

Turkey
Discover the potential

YENİ

| Ürün Kodu | Açıklama / Stok Cinsi | Ambalaj (Kutulu) | TL |
|----------------|---------------------------------------|------------------|---------|
| 112 039 011717 | 17 Ledli S/Ü Acil Aydınlatma Armatürü | 1 ad. | 126,499 |
| 112 039 013434 | 34 Ledli S/Ü Acil Aydınlatma Armatürü | 1 ad. | 136,916 |
| 112 039 015151 | 51 Ledli S/Ü Acil Aydınlatma Armatürü | 1 ad. | 151,798 |
| 112 039 121717 | 17 Ledli S/A Acil Aydınlatma Armatürü | 1 ad. | 135,428 |
| 112 039 123434 | 34 Ledli S/A Acil Aydınlatma Armatürü | 1 ad. | 145,846 |
| 112 039 125151 | 51 Ledli S/A Acil Aydınlatma Armatürü | 1 ad. | 160,728 |



| Kod | Açıklama / Stok Cinsi | Amb. (Kutu/Bağ) | Amb. (Kali/Cvli) | FİYAT |
|--|---|--------------------|---------------------|---------|
| PANO İÇİN SÜPER LÜX KANALLAR (GRİ) HALOGEN FREE (ALEV YAYMAYAN) | | | | |
| 001 065 025025 20 17 | 25X25 KABLO KAN. HALOGEN FREE (ALEV YAYMAYAN)(DELİKLİ)(GRİ) | 1mt. 64 | 2mt. 128 | 9,784 |
| 001 065 025040 20 17 | 25X40 KABLO KAN. HALOGEN FREE (ALEV YAYMAYAN)(DELİKLİ)(GRİ) | 1mt. 40 | 2mt. 80 | 12,865 |
| 001 065 040040 20 17 | 40X40 KABLO KAN. HALOGEN FREE (ALEV YAYMAYAN)(DELİKLİ)(GRİ) | 1mt. 25 | 2mt. 50 | 17,524 |
| 001 065 040060 20 17 | 40X60 KABLO KAN. HALOGEN FREE (ALEV YAYMAYAN)(DELİKLİ)(GRİ) | 1mt. 24 | 2mt. 48 | 20,509 |
| PANO İÇİN SÜPER LÜX KANALLAR (GRİ) | | | | |
| 001 005 025025 20 17 | 25X25 KABLO KAN.(DELİKLİ)(GRİ) | 1mt. 64 | 2mt. 128 | 3,243 |
| 001 005 025040 20 17 | 25X40 KABLO KAN.(DELİKLİ)(GRİ) | 1mt. 40 | 2mt. 80 | 5,022 |
| 001 005 025060 20 17 | 25X60 KABLO KAN.(DELİKLİ)(GRİ) | 1mt. 36 | 2mt. 80 | 6,285 |
| 001 005 040040 20 17 | 40X40 KABLO KAN.(DELİKLİ)(GRİ) | 1mt. 25 | 2mt. 50 | 5,812 |
| 001 005 040060 20 17 | 40X60 KABLO KAN.(DELİKLİ)(GRİ) | 1mt. 24 | 2mt. 48 | 6,773 |
| 001 005 060040 20 17 | 60X40 KABLO KAN.(DELİKLİ)(GRİ) | 1mt. 24 | 2mt. 48 | 6,773 |
| 001 005 060060 20 17 | 60X60 KABLO KAN.(DELİKLİ)(GRİ) | 1mt. 16 | 2mt. 32 | 7,722 |
| 001 005 060080 20 17 | 60X80 KABLO KAN.(DELİKLİ)(GRİ) | 1mt. 12 | 2mt. 24 | 9,757 |
| 001 005 060100 20 17 | 60X100 KABLO KAN.(DELİKLİ)(GRİ) | 1mt. 8 | 2mt. 16 | 12,168 |
| 001 005 040080 20 17 | 40X80 KABLO KAN.(DELİKLİ)(GRİ) | 1mt. 18 | 2mt. 36 | 8,610 |
| 001 005 080060 20 17 | 80X60 KABLO KAN.(DELİKLİ)(GRİ) | 1mt. 12 | 2mt. 24 | 9,757 |
| 001 005 100060 20 17 | 100X60 KABLO KAN.(DELİKLİ)(GRİ) | 1mt. 8 | 2mt. 16 | 12,168 |
| 001 005 100100 20 17 | 100X100 KABLO KAN.(DELİKLİ)(GRİ) | 1mt. 4 | 2mt. 8 | 18,693 |
| PANO İÇİN SÜPER LÜX KANALLAR (MAVİ-BEYAZ ŞERİT) | | | | |
| 001 005 025025 20 13 | 25X25 KABLO KAN.(DELİKLİ)(MAVİ) | 1mt. 64 | 2mt. 128 | 3,373 |
| 001 005 025040 20 13 | 25X40 KABLO KAN.(DELİKLİ)(MAVİ) | 1mt. 40 | 2mt. 80 | 5,223 |
| 001 005 025060 20 13 | 25X60 KABLO KAN.(DELİKLİ)(MAVİ) | 1mt. 36 | 2mt. 80 | 6,536 |
| 001 005 040040 20 13 | 40X40 KABLO KAN.(DELİKLİ)(MAVİ) | 1mt. 25 | 2mt. 50 | 6,045 |
| 001 005 040060 20 13 | 40X60 KABLO KAN.(DELİKLİ)(MAVİ) | 1mt. 24 | 2mt. 48 | 7,044 |
| 001 005 060040 20 13 | 60X40 KABLO KAN.(DELİKLİ)(MAVİ) | 1mt. 24 | 2mt. 48 | 7,044 |
| 001 005 060060 20 13 | 60X60 KABLO KAN.(DELİKLİ)(MAVİ) | 1mt. 16 | 2mt. 32 | 8,031 |
| 001 005 060080 20 13 | 60X80 KABLO KAN.(DELİKLİ)(MAVİ) | 1mt. 12 | 2mt. 24 | 10,148 |
| 001 005 060100 20 13 | 60X100 KABLO KAN.(DELİKLİ)(MAVİ) | 1mt. 8 | 2mt. 16 | 12,655 |
| 001 005 040080 20 13 | 40X80 KABLO KAN.(DELİKLİ)(MAVİ) | 1mt. 18 | 2mt. 36 | 8,954 |
| 001 005 080060 20 13 | 80X60 KABLO KAN.(DELİKLİ)(MAVİ) | 1mt. 12 | 2mt. 24 | 10,148 |
| 001 005 100060 20 13 | 100X60 KABLO KAN.(DELİKLİ)(MAVİ) | 1mt. 8 | 2mt. 16 | 12,655 |
| 001 005 100100 20 13 | 100X100 KABLO KAN.(DELİKLİ)(MAVİ) | 1mt. 4 | 2mt. 8 | 19,440 |
| YAPIŞKAN BANTLI DELİKLİ KANALLAR (MAVİ-BEYAZ-ŞERİT) | | | | |
| 001 008 025025 20 13 | 25X25 MM DEL.KANAL YPŞK.BANTLI (MAVİ) | 1mt. 64 | 2mt. 128 | 3,303 |
| 001 008 025040 20 13 | 25X40 MM DEL.KANAL YPŞK.BANTLI (MAVİ) | 1mt. 40 | 2mt. 80 | 4,955 |
| 001 008 025060 20 13 | 25X60 MM DEL.KANAL YPŞK.BANTLI (MAVİ) | 1mt. 36 | 2mt. 80 | 6,209 |
| 001 008 040040 20 13 | 40X40 MM DEL.KANAL YPŞK.BANTLI (MAVİ) | 1mt. 25 | 2mt. 50 | 6,098 |
| 001 008 040060 20 13 | 40X60 MM DEL.KANAL YPŞK.BANTLI (MAVİ) | 1mt. 24 | 2mt. 48 | 7,089 |
| 001 008 060040 20 13 | 60X40 MM DEL.KANAL YPŞK.BANTLI (MAVİ) | 1mt. 24 | 2mt. 48 | 8,182 |
| 001 008 060060 20 13 | 60X60 MM DEL.KANAL YPŞK.BANTLI (MAVİ) | 1mt. 16 | 2mt. 32 | 8,939 |
| 001 008 060080 20 13 | 60X80 MM DEL.KANAL YPŞK.BANTLI (MAVİ) | 1mt. 12 | 2mt. 24 | 12,578 |
| 001 008 060100 20 13 | 60X100 MM DEL.KANAL YPŞK.BANTLI (MAVİ) | 1mt. 8 | 2mt. 16 | 13,436 |
| 001 008 040080 20 13 | 40X80 MM DEL.KANAL YPŞK.BANTLI (MAVİ) | 1mt. 18 | 2mt. 36 | 9,114 |
| 001 008 080060 20 13 | 80X60 MM DEL.KANAL YPŞK.BANTLI (MAVİ) | 1mt. 12 | 2mt. 24 | 12,578 |
| 001 008 100060 20 13 | 100X60 MM DEL.KANAL YPŞK.BANTLI (MAVİ) | 1mt. 8 | 2mt. 16 | 13,436 |
| 001 008 100100 20 13 | 100X100 MM DEL.KANAL YPŞK.BANTLI (MAVİ) | 1mt. 4 | 2mt. 8 | 18,804 |
| YAPIŞKAN BANTLI DELİKLİ KANALLAR (GRİ) | | | | |
| 001 008 025025 20 17 | 25X25 MM DEL.KANAL YPŞK.BANTLI (GRİ) | 1mt. 64 | 2mt. 128 | 3,240 |
| 001 008 025040 20 17 | 25X40 MM DEL.KANAL YPŞK.BANTLI (GRİ) | 1mt. 40 | 2mt. 80 | 4,828 |
| 001 008 025060 20 17 | 25X60 MM DEL.KANAL YPŞK.BANTLI (GRİ) | 1mt. 36 | 2mt. 80 | 6,203 |
| 001 008 040040 20 17 | 40X40 MM DEL.KANAL YPŞK.BANTLI (GRİ) | 1mt. 25 | 2mt. 50 | 6,035 |
| 001 008 040060 20 17 | 40X60 MM DEL.KANAL YPŞK.BANTLI (GRİ) | 1mt. 24 | 2mt. 48 | 6,861 |
| 001 008 060040 20 17 | 60X40 MM DEL.KANAL YPŞK.BANTLI (GRİ) | 1mt. 24 | 2mt. 48 | 7,496 |
| 001 008 060060 20 17 | 60X60 MM DEL.KANAL YPŞK.BANTLI (GRİ) | 1mt. 16 | 2mt. 32 | 8,932 |
| 001 008 060080 20 17 | 60X80 MM DEL.KANAL YPŞK.BANTLI (GRİ) | 1mt. 12 | 2mt. 24 | 10,788 |
| 001 008 060100 20 17 | 60X100 MM DEL.KANAL YPŞK.BANTLI (GRİ) | 1mt. 8 | 2mt. 16 | 12,324 |
| 001 008 040080 20 17 | 40X80 MM DEL.KANAL YPŞK.BANTLI (GRİ) | 1mt. 18 | 2mt. 36 | 9,148 |
| 001 008 080060 20 17 | 80X60 MM DEL.KANAL YPŞK.BANTLI (GRİ) | 1mt. 12 | 2mt. 24 | 10,788 |
| 001 008 100060 20 17 | 100X60 MM DEL.KANAL YPŞK.BANTLI (GRİ) | 1mt. 8 | 2mt. 16 | 12,324 |
| 001 008 100100 20 17 | 100X100 MM DEL.KANAL YPŞK.BANTLI (GRİ) | 1mt. 4 | 2mt. 8 | 18,786 |
| HAREKETLİ KABLO KANALLARI | | | | |
| 888 140 001515 | 15x15 MM HAREKETLİ KABLO KANALI | | 1 mt. | 26,450€ |
| 888 140 001825 | 18x25 MM HAREKETLİ KABLO KANALI | | 1 mt. | 26,450€ |
| 888 140 002025 | 20x25 MM HAREKETLİ KABLO KANALI | | 1 mt. | 35,785€ |
| 888 140 002040 | 20X40 MM HAREKETLİ KABLO KANALI | | 1 mt. | 37,341€ |
| 888 140 002050 | 20X50 MM HAREKETLİ KABLO KANALI | | 1 mt. | 40,453€ |
| 888 140 002540 | 25x40 MM HAREKETLİ KABLO KANALI | | 1 mt. | 40,453€ |
| 888 140 003040 | 30x40 MM HAREKETLİ KABLO KANALI | | 1 mt. | 46,676€ |
| 888 140 003041 | MONTAJ AYAKLARI (1 TAKIM) | | 1 mt. | 6,224€ |

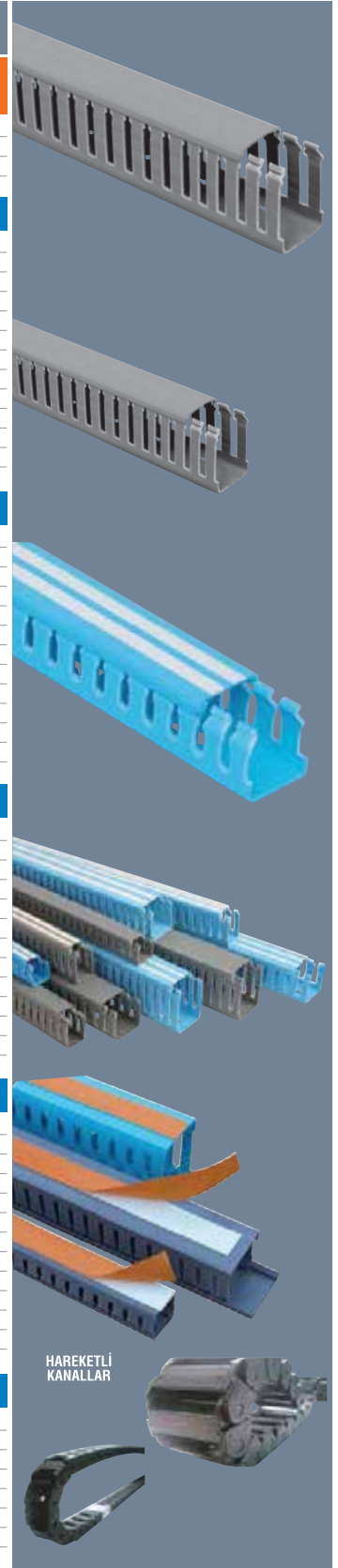

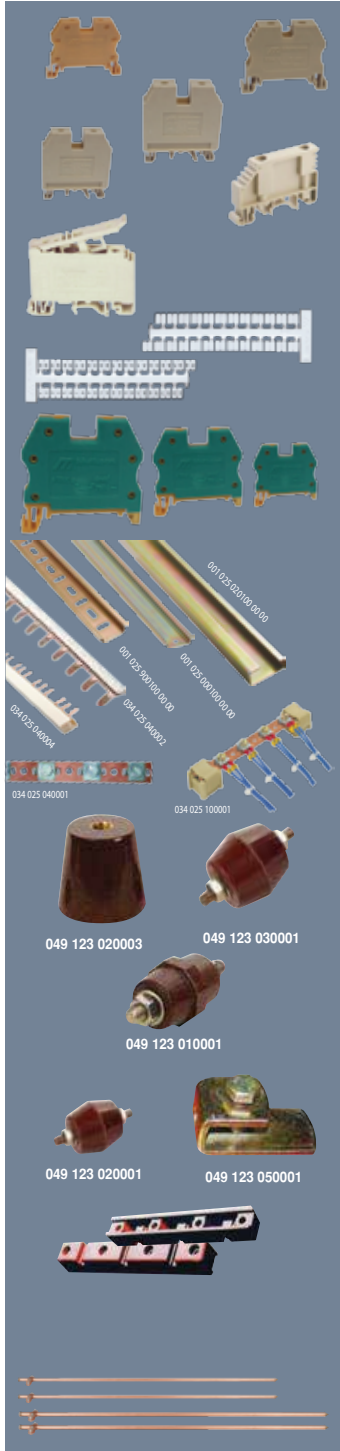

| Kod | Açıklama / Stok Cinsi | Amb. (Kutu/Baz) | Amb. (Koli/Çvt.) | FİYAT |
|--|---|--------------------|---------------------|---------|
| RAY KLEMENSLER (VİDALI) | | | | |
| 010 094 000025 | 2,5 MM RAY KLEMENSİ | 100 ad. | | 1,458 |
| 010 094 000004 | 4 MM RAY KLEMENSİ | 100 ad. | | 1,578 |
| 010 094 000006 | 6 MM RAY KLEMENSİ | 100 ad. | | 2,024 |
| 010 094 000010 | 10 MM RAY KLEMENSİ | 100 ad. | | 2,738 |
| 010 094 000016 | 16 MM RAY KLEMENSİ | 100 ad. | | 4,316 |
| 010 094 000035 | 35 MM RAY KLEMENSİ | 30 ad. | | 6,846 |
| 010 094 010001 | KLEMENS DURDURUCU | 20 ad. | | 1,131 |
| RAY KLEMENSLER (TOPRAKLAMALI) | | | | |
| 010 094 000051 | SİGORTALI RAY KLEMENS | 75 ad. | | 6,224 |
| RAY KLEMENSLER (TOPRAKLAMALI) | | | | |
| 010 094 010006 | YAZILI DEKAFİKS (1 ADET FİYATI) | 500 ad. | | 0,069 |
| 010 094 010007 | YAZISIZ DEKAFİKS (1 ADET FİYATI) | 500 ad. | | 0,053 |
| RAY KLEMENSLER (TOPRAKLAMALI) | | | | |
| 010 094 010003 | 2,5 MM TOPRAKLAMALI RAY KLEMENSİ | 100 ad. | | 5,195 |
| 010 094 010008 | 4 MM TOPRAKLAMALI RAY KLEMENSİ | 100 ad. | | 5,195 |
| 010 094 010004 | 6 MM TOPRAKLAMALI RAY KLEMENSİ | 100 ad. | | 6,494 |
| 010 094 010009 | 10 MM TOPRAKLAMALI RAY KLEMENSİ | 100 ad. | | 6,494 |
| 010 094 010005 | 16 MM TOPRAKLAMALI RAY KLEMENSİ | 30 ad. | | 12,176 |
| 010 094 010010 | 35 MM TOPRAKLAMALI RAY KLEMENSİ | 20 ad. | | 12,988 |
| RAYLAR-TOPRAKLAMA ÇUBUKLARI VE BARALAR | | | | |
| 014 094 020001 | RAY TAŞIYICISI (SAC) | 150 ad. | | 1,369 |
| 001 025 020100 00 00 | KLEMENS RAYI(1M) | 25 mt. | | 8,475 |
| 001 025 000100 00 00 | W OTOMAT RAYI(1M) | 50 mt. | | 4,663 |
| 001 025 000033 00 00 | W OTOMAT RAYI(33CM) | 50 ad. | | 1,503 |
| 001 025 000099 99 00 | W OTOMAT RAYI(ÖZEL BOY) | 50 ad. | | 4,128 |
| 001 025 900100 00 00 | W OTOMAT RAYI(DELİKLİ)(1M) | 50 mt. | | 4,614 |
| 034 025 100001 | TOPRAKLAMA BARASI MESNEDİ | 50 ad. | | 0,923 |
| 034 025 040001 | TOPRAKLAMA BARASI 1 M. | 40 ad. | | 26,606 |
| 034 025 040004 | TRİF. MÜŞTEREK BARA İĞNE UÇLU 53 CM | 24 ad. | | 27,850 |
| 034 025 040006 | TRİF.MÜŞTEREK BARA İĞNE UÇLU 106 CM | 24 ad. | | 55,608 |
| 034 025 040002 | MON.MÜŞTEREK BARA İĞNE UÇLU 106 CM | 50 ad. | | 20,351 |
| MİNİ BOY MESNET İZOLATÖRLERİ A.G. (1KV) | | | | |
| 049 123 010001 | BMI-M 5/2C MİNİ İZOLATÖR | 250 ad. | | 0,887 |
| 049 123 010002 | BMI-M 5/1C+1S MİNİ İZOLATÖR | 250 ad. | | 1,254 |
| 049 123 010003 | BMI-M 5/2S MİNİ İZOLATÖR | 250 ad. | | 1,376 |
| ORTA BOY KONİK MESNET İZOLATÖRLERİ A.G. (1KV) | | | | |
| 049 123 020001 | BMI-M 6/2C ORTA KONİK İZOLATÖR | 100 ad. | | 1,601 |
| 049 123 020002 | BMI-M 6/1C+1S ORTA KONİK İZOLATÖR | 100 ad. | | 1,994 |
| 049 123 020003 | BMI-M 6/2S ORTA KONİK İZOLATÖR | 100 ad. | | 2,173 |
| BÜYÜK BOY MESNET İZOLATÖRLERİ A.G. (1KV) | | | | |
| 049 123 030001 | BMI-M 8/2C BÜYÜK BOY KONİK İZOLATÖR | 40 ad. | | 2,338 |
| 049 123 030002 | BMI-M 8/1C+1S BÜYÜK BOY KONİK İZOLATÖR | 40 ad. | | 2,883 |
| 049 123 030003 | BMI-M 8/2S BÜYÜK BOY KONİK İZOLATÖR | 40 ad. | | 3,171 |
| 049 123 030004 | BMI-M 10/2C BÜYÜK BOY KONİK İZOLATÖR | 40 ad. | | 2,883 |
| 049 123 030005 | BMI-M 10/1C+1S BÜYÜK BOY KONİK İZOLATÖR | 40 ad. | | 3,206 |
| 049 123 030006 | BMI-M 10/2S BÜYÜK BOY KONİK İZOLATÖR | 40 ad. | | 3,523 |
| 049 123 050001 | BMS (M8-M10) BARA TUTUCU | 50 ad. | | 3,492 |
| TARAK İZOLATÖRLER | | | | |
| 049 123 040001 | 3X1 F TARAK İZOLATÖR (2ADET TAKIM) | 20 tkm. | | 13,394 |
| 049 123 040002 | 3X2 F TARAK İZOLATÖR (2ADET TAKIM) | 20 tkm. | | 16,371 |
| 049 123 040003 | 3X1 F+N TARAK İZOLATÖR (2ADET TAKIM) | 20 tkm. | | 17,115 |
| 049 123 040005 | 3X2 F+N TARAK İZOLATÖR (2ADET TAKIM) | 4 tkm. | | 21,579 |
| BORU GEÇME TOPRAKLAMA ÇUBUĞU | | | | |
| 091 025 011610 | TOP ÇUBUĞU BORU GEÇMELİ 16 MM 1 MT | 10 ad. | | 44,877 |
| 091 025 011615 | TOP ÇUBUĞU BORU GEÇMELİ 16 MM 1,5 MT | 10 ad. | | 68,039 |
| 091 025 012010 | TOP ÇUBUĞU BORU GEÇMELİ 20 MM 1 MT | 10 ad. | | 71,659 |
| 091 025 012015 | TOP ÇUBUĞU BORU GEÇMELİ 20 MM 1,5 MT | 10 ad. | | 107,126 |

| Kod | Açıklama / Stok Cinsi | Amb. (Kutu/Bağ) | Amb. (Koli/Çv.) | FİYAT |
|---|---|--------------------|--------------------|-------|
| CABLE FIX KABLO BAĞLARI | | | | |
| CE | | | | |
| 062 129 925100 | KABLO BAĞI 2.5X100 | 100 ad. | 40000 | 0,015 |
| 062 129 925150 | KABLO BAĞI 2.5X150 | 100 ad. | 20000 | 0,025 |
| 062 129 925200 | KABLO BAĞI 2.5X200 | 100 ad. | 15000 | 0,033 |
| 062 129 936150 | KABLO BAĞI 3.6X150 | 100 ad. | 10000 | 0,041 |
| 062 129 936200 | KABLO BAĞI 3.6X200 | 100 ad. | 10000 | 0,051 |
| 062 129 936250 | KABLO BAĞI 3.6X250 | 100 ad. | 10000 | 0,060 |
| 062 129 936300 | KABLO BAĞI 3.6X300 | 100 ad. | 10000 | 0,067 |
| 062 129 936370 | KABLO BAĞI 3.6X370 | 100 ad. | 10000 | 0,079 |
| 062 129 948200 | KABLO BAĞI 4.8X200 | 100 ad. | 10000 | 0,060 |
| 062 129 948250 | KABLO BAĞI 4.8X250 | 100 ad. | 10000 | 0,073 |
| 062 129 948300 | KABLO BAĞI 4.8X300 | 100 ad. | 10000 | 0,094 |
| 062 129 948380 | KABLO BAĞI 4.8X380 | 100 ad. | 5000 | 0,109 |
| 062 129 948400 | KABLO BAĞI 4.8X400 | 100 ad. | 5000 | 0,112 |
| 062 129 976300 | KABLO BAĞI 7.6X300 | 100 ad. | 3000 | 0,298 |
| 062 129 976380 | KABLO BAĞI 7.6X380 | 100 ad. | 2500 | 0,216 |
| 062 129 972450 | KABLO BAĞI 7.2X450 | 100 ad. | 3000 | 0,607 |
| 062 129 976550 | KABLO BAĞI 7.6X550 | 100 ad. | 2500 | 0,615 |
| 062 129 990750 | KABLO BAĞI 9X750 | 100 ad. | 1000 | 0,626 |
| 062 129 990900 | KABLO BAĞI 9X900 | 100 ad. | 1000 | 0,930 |
| 060 129 101919 | YAPIŞKANLI KROŞE 19x19 | 100 ad. | 10000 | 0,116 |
| 060 129 102828 | YAPIŞKANLI KROŞE 28X28 | 100 ad. | 4000 | 0,146 |
| 062 129 211017 | VIDALI KROŞE 10x17 | 250 ad. | 25000 | 0,069 |
| 062 129 211530 | VIDALI KROŞE 15X30 | 100 ad. | 10000 | 0,086 |
| 062 129 211723 | VIDALI KROŞE 17X23 | 100 ad. | 8000 | 0,086 |
| PEMSAN YERLİ KABLO BAĞLARI (SİYAH-BEYAZ) | | | | |
| 062 129 010101 | EA.01.101 BONCUK KELEPÇE 2X105 | 1000 ad. | | 0,031 |
| 062 129 010102 | EA.02.102 BONCUK KELEPÇE 3.5X165 | 500 ad. | | 0,062 |
| 062 129 025100 | EB.02.202 KABLO BAĞI 2.5X100 | 1000 ad. | 50000 | 0,016 |
| 062 129 025140 | EB.12.212 KABLO BAĞI 2.5X140 | 100 ad. | 35000 | 0,027 |
| 062 129 025200 | EB.13.213 KABLO BAĞI 2.5X200 | 100 ad. | 30000 | 0,041 |
| 062 129 036150 | EB.03.203 KABLO BAĞI 3.6X150 | 100 ad. | 25000 | 0,041 |
| 062 129 036205 | EB.04.204 KABLO BAĞI 3.6X205 | 100 ad. | 20000 | 0,056 |
| 062 129 036250 | EB.09.209 KABLO BAĞI 3.6X250 | 100 ad. | 15000 | 0,073 |
| 062 129 036300 | EB.10.210 KABLO BAĞI 3.6X300 | 100 ad. | 15000 | 0,087 |
| 062 129 036370 | EB.11.211 KABLO BAĞI 3.6X370 | 100 ad. | 10000 | 0,111 |
| 062 129 048200 | EB.14.214 KABLO BAĞI 4.8X200 | 100 ad. | 15000 | 0,081 |
| 062 129 048250 | EB.06.206 KABLO BAĞI 4.8X250 | 100 ad. | 10000 | 0,099 |
| 062 129 048300 | EB.05.205 KABLO BAĞI 4.8X300 | 100 ad. | 10000 | 0,118 |
| 062 129 048400 | EB.16.216 KABLO BAĞI 4.8X400 | 100 ad. | 7500 | 0,148 |
| 062 129 008250 | EB.07.207 KABLO BAĞI 8X250 | 100 ad. | 6000 | 0,198 |
| 062 129 008300 | EB.18.218 KABLO BAĞI 8X300 | 100 ad. | 5000 | 0,214 |
| 062 129 008380 | EB.19.219 KABLO BAĞI 8X380 | 100 ad. | 4000 | 0,267 |
| 062 129 008450 | EB.21.221 KABLO BAĞI 8X450 | 100 ad. | 3000 | 0,329 |
| 062 129 008550 | EB.15.215 KABLO BAĞI 8X550 | 100 ad. | 4000 | 0,434 |
| 062 129 008750 | EB.24.224 KABLO BAĞI 8X750 | 100 ad. | 3000 | 0,652 |
| 062 129 009940 | EB.22.222 KABLO BAĞI 9X940 | 100 ad. | 1500 | 1,135 |
| 062 129 009762 | EB.17.217 KABLO BAĞI 9X762 | 100 ad. | 1500 | 0,823 |
| 062 129 010205 | PV.40.205 DELIKLİ KABLO BAĞI 4X205 | 100 ad. | 1500 | 0,119 |
| KROŞE VE KLİPSLER | | | | |
| 062 129 132020 | EK.01.1001 YAPIŞKANLI KROŞE 20X20 | 100 ad. | | 0,121 |
| 062 129 132828 | EK.03.1003 YAPIŞKANLI KROŞE 28X28 | 100 ad. | | 0,174 |
| 062 129 131316 | EK.16.1016 YAPIŞKANLI KLİPS 13X16 | 100 ad. | | 0,145 |
| 062 129 132525 | EK.05.1005 YAPIŞKANLI KLİPS 25X25 | 100 ad. | | 0,255 |
| 062 129 191325 | EK.19.1019 YAPIŞKANLI KLİPS 13X25 | 100 ad. | | 0,194 |
| 062 129 142525 | EK.07.1007 YAPIŞKANLI KLİPS 25X25 | 100 ad. | | 0,271 |
| 062 129 151017 | EK.06.1006 VIDALI KROŞE 10X17 | 250 ad. | | 0,089 |
| 062 129 151723 | EK.02.1002 VIDALI KROŞE 17X23 | 250 ad. | | 0,112 |
| 062 129 151530 | EK.13.1013 VIDALI KROŞE 15X30 | 100 ad. | | 0,125 |
| 062 129 161004 | EK.04.1004 DÜBELLİ KROŞE 6 DELİK İÇİN | 500 ad. | | 0,105 |
| 062 129 171009 | EK.09.1009 DUVAR KROŞESİ 6 DELİK İÇİN | 250 ad. | | 0,102 |
| 062 129 171048 | EK.10.1010 DÜBELLİ KABLO TUTUCU Q4,8 DELİK İÇİN | 250 ad. | | 0,106 |
| 033 129 100008 | KANAL KROŞESİ 8 DELİK İÇİN | 250 ad. | | 0,113 |
| 062 129 171011 | EK.11.1011 KANAL KROŞESİ 6 DELİK İÇİN | 250 ad. | | 0,091 |
| PEMSAN BURMA TİP KELEPÇELER | | | | |
| 060 120 005105 | EA.05.105 BURMA KELEPÇE | 500 ad. | | 0,060 |
| 060 120 007107 | EA.07.107 BURMA KELEPÇE | 500 ad. | | 0,080 |
| 060 120 010110 | EA.10.110 BURMA KELEPÇE | 500 ad. | | 0,085 |
| 060 120 014114 | EA.14.114 BURMA KELEPÇE | 500 ad. | | 0,113 |
| 060 120 017117 | EA.17.117 BURMA KELEPÇE | 500 ad. | | 0,142 |
| ETİKETLER | | | | |
| 062 129 111035 | ET.07.907 KABLO BAĞI ETİKETİ 10X35 | 100 ad. | | 0,353 |
| 062 129 112045 | ET.06.906 KABLO BAĞI ETİKETİ 20X45 | 100 ad. | | 0,483 |
| 062 129 121530 | ET.02.902 YAPIŞKANLI PANO ETİKETİ 15X30 | 100 ad. | | 0,421 |
| 062 129 121750 | ET.03.903 YAPIŞKANLI PANO ETİKETİ 17X50 | 50 ad. | | 0,604 |
| 062 129 122075 | ET.04.904 YAPIŞKANLI PANO ETİKETİ 17X75 | 25 ad. | | 0,820 |

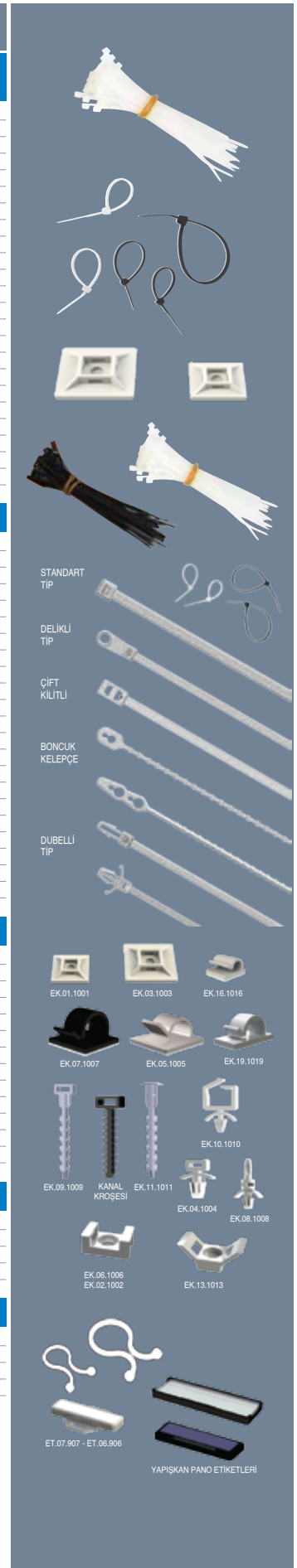

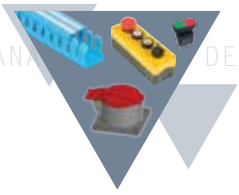

| Kod | Açıklama / Stok Cinsi | Amb. (Kutu/Bağ) | Amb. (Kali/Çal.) | FİYAT |
|--|--|--------------------|---------------------|--------------|
| SIKMALI TİP KABLO PAPUÇLARI (İTHAL) | | | | |
| 123 037 000010 | 10 MM2 SIKMALI TİP KABLO PAPUCU (İTHAL) M5 | 800 ad. | | 0,372 |
| 123 037 000016 | 16 MM2 SIKMALI TİP KABLO PAPUCU (İTHAL) M6 | 500 ad. | | 0,491 |
| 123 037 000025 | 25 MM2 SIKMALI TİP KABLO PAPUCU (İTHAL) M8 | 350 ad. | | 0,878 |
| 123 037 000035 | 35 MM2 SIKMALI TİP KABLO PAPUCU (İTHAL) M8 | 200 ad. | | 1,250 |
| 123 037 000050 | 50 MM2 SIKMALI TİP KABLO PAPUCU (İTHAL) M10 | 150 ad. | | 1,607 |
| 123 037 000070 | 70 MM2 SIKMALI TİP KABLO PAPUCU (İTHAL) M10 | 100 ad. | | 2,679 |
| 123 037 000095 | 95 MM2 SIKMALI TİP KABLO PAPUCU (İTHAL) M12 | 70 ad. | | 3,125 |
| 123 037 000120 | 120 MM2 SIKMALI TİP KABLO PAPUCU (İTHAL) M12 | 50 ad. | | 4,316 |
| 123 037 000150 | 150 MM2 SIKMALI TİP KABLO PAPUCU (İTHAL) M12 | 40 ad. | | 7,441 |
| 123 037 000185 | 185 MM2 SIKMALI TİP KABLO PAPUCU (İTHAL) M16 | 30 ad. | | 8,632 |
| 123 037 000240 | 240 MM2 SIKMALI TİP KABLO PAPUCU (İTHAL) M16 | 24 ad. | | 13,096 |
| 123 037 000300 | 300 MM2 SIKMALI TİP KABLO PAPUCU (İTHAL) M16 | 20 ad. | | 16,668 |
| SIKMALI TİP KABLO PAPUÇLARI (STANDART) | | | | |
| 123 037 500006 | 6 MM2 SIKMALI TİP KABLO PAPUCU (STANDART SERİSİ) M5 | 1000 ad. | | 0,358 |
| 123 037 500010 | 10 MM2 SIKMALI TİP KABLO PAPUCU (STANDART SERİSİ) M5 | 800 ad. | | 0,513 |
| 123 037 500016 | 16 MM2 SIKMALI TİP KABLO PAPUCU (STANDART SERİSİ) M6 | 500 ad. | | 0,747 |
| 123 037 500025 | 25 MM2 SIKMALI TİP KABLO PAPUCU (STANDART SERİSİ) M8 | 350 ad. | | 1,229 |
| 123 037 500035 | 35 MM2 SIKMALI TİP KABLO PAPUCU (STANDART SERİSİ) M8 | 200 ad. | | 1,649 |
| 123 037 500050 | 50 MM2 SIKMALI TİP KABLO PAPUCU (STANDART SERİSİ) M10 | 150 ad. | | 2,753 |
| 123 037 500070 | 70 MM2 SIKMALI TİP KABLO PAPUCU (STANDART SERİSİ) M10 | 100 ad. | | 3,572 |
| 123 037 500095 | 95 MM2 SIKMALI TİP KABLO PAPUCU (STANDART SERİSİ) M12 | 70 ad. | | 4,762 |
| 123 037 500120 | 120 MM2 SIKMALI TİP KABLO PAPUCU (STANDART SERİSİ) M12 | 50 ad. | | 6,995 |
| 123 037 500150 | 150 MM2 SIKMALI TİP KABLO PAPUCU (STANDART SERİSİ) M12 | 40 ad. | | 11,162 |
| 123 037 500185 | 185 MM2 SIKMALI TİP KABLO PAPUCU (STANDART SERİSİ) M16 | 30 ad. | | 13,841 |
| 123 037 500240 | 240 MM2 SIKMALI TİP KABLO PAPUCU (STANDART SERİSİ) M16 | 24 ad. | | 18,603 |
| 123 037 500300 | 300 MM2 SIKMALI TİP KABLO PAPUCU (STANDART SERİSİ) M16 | 20 ad. | | 23,216 |
| STANDART TİP SIKMALI KABLO EK MUFLARI | | | | |
| 123 037 300010 | 10 MM2 BORU TİP SIKMALI EK MUFU | 800 ad. | | 0,506 |
| 123 037 300016 | 16 MM2 BORU TİP SIKMALI EK MUFU | 500 ad. | | 0,729 |
| 123 037 300025 | 25MM2 BORU TİP SIKMALI EK MUFU | 350 ad. | | 1,131 |
| 123 037 300035 | 35 MM2 BORU TİP SIKMALI EK MUFU | 200 ad. | | 1,429 |
| 123 037 300050 | 50 MM2 BORU TİP SIKMALI EK MUFU | 150 ad. | | 2,009 |
| 123 037 300070 | 70 MM2 BORU TİP SIKMALI EK MUFU | 100 ad. | | 3,215 |
| 123 037 300095 | 95 MM2 BORU TİP SIKMALI EK MUFU | 70 ad. | | 3,721 |
| 123 037 300120 | 120 MM2 BORU TİP SIKMALI EK MUFU | 50 ad. | | 4,956 |
| 123 037 300150 | 150 MM2 BORU TİP SIKMALI EK MUFU | 40 ad. | | 8,438 |
| 123 037 300185 | 185 MM2 BORU TİP SIKMALI EK MUFU | 30 ad. | | 10,135 |
| 123 037 300240 | 240 MM2 BORU TİP SIKMALI EK MUFU | 24 ad. | | 15,671 |
| MEKANİK SKP SIKMA PENSELERİ | | | | |
| 014 101 000650 | JY-0650A MEKANİK SKP SIKMA PENSESİ(6-50) | 1 ad. | | 118,850 \$ |
| 014 101 000620 | JY-06120 MEKANİK SKP SIKMA PENSESİ(6-20) | 1 ad. | | 237,701 \$ |
| 014 101 025150 | JY-25150 MEKANİK SKP SIKMA PENSESİ(25-150) | 1 ad. | | 246,720 \$ |
| 014 101 070240 | JY-70240 MEKANİK SKP SIKMA PENSESİ(70-240) | 1 ad. | | 262,019 \$ |
| HİDROLİK SKP SIKMA PENSELERİ | | | | |
| 014 101 004070 | YQK-70 HİDROLİK SKP SIKMA PENSESİ (4-70) | 1 ad. | | 178,586 \$ |
| 014 101 010120 | YYQ-120 HİDROLİK SKP SIKMA PENSESİ (10-120) | 1 ad. | | 193,469 \$ |
| 014 101 016240 | YQK-240 HİDROLİK SKP SIKMA PENSESİ (16-240) | 1 ad. | | 223,233 \$ |
| 014 101 016300 | YQK-300 HİDROLİK SKP SIKMA PENSESİ (16-300) | 1 ad. | | 1,617,631 \$ |
| 014 101 016300 | HZ-300 HİDROLİK SKP SIKMA PENSESİ (16-300) | 1 ad. | | 1,617,631 \$ |
| 014 101 016400 | HZ-400 HİDROLİK SKP SIKMA PENSESİ (16-400) | 1 ad. | | 1,860,276 \$ |
| YÜKSÜK VE İZOLELİ KABLO UCU SIKMA PENSELERİ | | | | |
| 014 101 005056 | YAC-5 YÜKSÜK SIKMA PENSESİ(0,5-6) | 1 ad. | | 76,871 \$ |
| 014 101 006616 | YAC-6 YÜKSÜK SIKMA PENSESİ(6-16) | 1 ad. | | 92,228 \$ |
| 014 101 008056 | YAC-8 YÜKSÜK SIKMA PENSESİ(0,5-6)(İZOLELİ KABLO UCU) | 1 ad. | | 133,322 \$ |
| 014 101 001056 | YYT-1 İZOLELİ KABLO UCU SIKMA PENSESİ(0,5-6) | 1 ad. | | 74,687 \$ |
| 014 101 011014 | YYT-11 İZOLELİ KABLO UCU SIKMA PENSESİ(1-4) | 1 ad. | | 86,479 \$ |

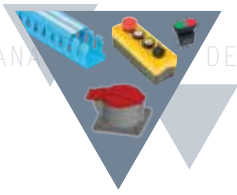

| Kod | Açıklama / Stok Cinsi | Amb. (Kutu/Bağ) | Amb. (Kali/Çet.) | FİYAT |
|---------------------------------------|---|--------------------|---------------------|---------|
| İZOLELİ TEK GİRİŞLİ YÜKSÜK | | | | |
| 014 100 010508 | ITY-0508 İZO.TEK GİRİŞ. YÜKSÜK 0,50 MM | 500 ad. | | 0,017\$ |
| 014 100 017508 | ITY-7508 İZO.TEK GİRİŞ. YÜKSÜK 0,75 MM | 500 ad. | | 0,017\$ |
| 014 100 011008 | ITY-1008 İZO.TEK GİRİŞ. YÜKSÜK 1,00 MM | 500 ad. | | 0,017\$ |
| 014 100 011508 | ITY-1508 İZO.TEK GİRİŞ. YÜKSÜK 1,50 MM | 500 ad. | | 0,017\$ |
| 014 100 012508 | ITY-2508 İZO.TEK GİRİŞ. YÜKSÜK 2,50 MM | 500 ad. | | 0,022\$ |
| 014 100 014009 | ITY-4009 İZO.TEK GİRİŞ. YÜKSÜK 4,00 MM | 250 ad. | | 0,037\$ |
| 014 100 016012 | ITY-6012 İZO.TEK GİRİŞ. YÜKSÜK 6,00 MM | 250 ad. | | 0,050\$ |
| 014 100 011012 | ITY-1012 İZO.TEK GİRİŞ. YÜKSÜK 10,00 MM | 100 ad. | | 0,066\$ |
| 014 100 011612 | ITY-1612 İZO.TEK GİRİŞ. YÜKSÜK 16,00 MM | 100 ad. | | 0,100\$ |
| 014 100 012516 | ITY-2516 İZO.TEK GİRİŞ. YÜKSÜK 25,00 MM | 50 ad. | | 0,193\$ |
| 014 100 013516 | ITY-3516 İZO.TEK GİRİŞ. YÜKSÜK 35,00 MM | 40 ad. | | 0,260\$ |
| 014 100 015020 | ITY-5020 İZO.TEK GİRİŞ. YÜKSÜK 50,00 MM | 20 ad. | | 0,377\$ |
| İZOLELİ ÇİFT GİRİŞLİ YÜKSÜK | | | | |
| 014 100 020508 | ICY-0508 İZO.ÇİFT GİRİŞ. YÜKSÜK 2X0,5 MM | 500 ad. | | 0,038\$ |
| 014 100 027508 | ICY-7508 İZO.ÇİFT GİRİŞ. YÜKSÜK 2X0,75MM | 500 ad. | | 0,038\$ |
| 014 100 021008 | ICY-1008 İZO.ÇİFT GİRİŞ. YÜKSÜK 2X1 MM | 500 ad. | | 0,038\$ |
| 014 100 021508 | ICY-1508 İZO.ÇİFT GİRİŞ. YÜKSÜK 2X1,5 MM | 500 ad. | | 0,039\$ |
| 014 100 022510 | ICY-2510 İZO.ÇİFT GİRİŞ. YÜKSÜK 2X2,5 MM | 250 ad. | | 0,047\$ |
| 014 100 024012 | ICY-4012 İZO.ÇİFT GİRİŞ. YÜKSÜK 2X4 MM | 100 ad. | | 0,140\$ |
| 014 100 026014 | ICY-6014 İZO.ÇİFT GİRİŞ. YÜKSÜK 2X6 MM | 100 ad. | | 0,148\$ |
| İZOLELİ YUVARLAK TİP PAPUÇ | | | | |
| 014 100 030154 | IYP-1,5-4 İZO.YUV.TİP PAP. 0,5-1,5MM(M4) | 200 ad. | | 0,047\$ |
| 014 100 030155 | IYP-1,5-5 İZO.YUV.TİP PAP. 0,5-1,5MM(M5) | 200 ad. | | 0,054\$ |
| 014 100 030156 | IYP-1,5-6 İZO.YUV.TİP PAP. 0,5-1,5MM(M6) | 200 ad. | | 0,069\$ |
| 014 100 030158 | IYP-1,5-8 İZO.YUV.TİP PAP. 0,5-1,5MM(M8) | 200 ad. | | 0,075\$ |
| 014 100 030254 | IYP-2,5-4 İZO.YUV.TİP PAP. 1,5-2,5MM(M4) | 200 ad. | | 0,055\$ |
| 014 100 030255 | IYP-2,5-5 İZO.YUV.TİP PAP. 1,5-2,5MM(M5) | 200 ad. | | 0,056\$ |
| 014 100 030256 | IYP-2,5-6 İZO.YUV.TİP PAP. 1,5-2,5MM(M6) | 200 ad. | | 0,081\$ |
| 014 100 030258 | IYP-2,5-8 İZO.YUV.TİP PAP. 1,5-2,5MM(M8) | 200 ad. | | 0,081\$ |
| 014 100 036004 | IYP-6-4 İZO.YUV.TİP PAP. 4-6MM(M4) | 100 ad. | | 0,094\$ |
| 014 100 036005 | IYP-6-5 İZO.YUV.TİP PAP. 4-6 MM(M5) | 100 ad. | | 0,119\$ |
| 014 100 036006 | IYP-6-6 İZO.YUV.TİP PAP. 4-6MM(M6) | 100 ad. | | 0,138\$ |
| 014 100 036008 | IYP-6-8 İZO.YUV.TİP PAP. 4-6MM(M8) | 100 ad. | | 0,155\$ |
| İZOLELİ ÇATAL TİP PAPUÇ | | | | |
| 014 100 040154 | ICP-1,5-4 İZO.ÇTL.TİP PAP. 0,5-1,5MM(M4) | 200 ad. | | 0,051\$ |
| 014 100 040155 | ICP-1,5-5 İZO.ÇTL.TİP PAP. 0,5-1,5MM(M5) | 200 ad. | | 0,059\$ |
| 014 100 040156 | ICP-1,5-6 İZO.ÇTL.TİP PAP. 0,5-1,5MM(M6) | 200 ad. | | 0,069\$ |
| 014 100 040254 | ICP-2,5-4 İZO.ÇTL.TİP PAP. 0,5-1,5MM(M4) | 200 ad. | | 0,054\$ |
| 014 100 040255 | ICP-2,5-5 İZO.ÇTL.TİP PAP. 0,5-1,5MM(M5) | 200 ad. | | 0,059\$ |
| 014 100 040256 | ICP-2,5-6 İZO.ÇTL.TİP PAP. 0,5-1,5MM(M6) | 200 ad. | | 0,074\$ |
| 014 100 046004 | ICP-6-4 İZO.ÇTL.TİP PAP. 4-6 MM(M4) | 100 ad. | | 0,111\$ |
| 014 100 046005 | ICP-6-5 İZO.ÇTL.TİP PAP. 4-6 MM(M5) | 100 ad. | | 0,117\$ |
| 014 100 046006 | ICP-6-6 İZO.ÇTL.TİP PAP. 4-6 MM(M6) | 100 ad. | | 0,124\$ |
| İZOLELİ İĞNE TİP TERMİNAL | | | | |
| 014 100 050015 | IIT-1,5 İZOLELİ İĞNE TİP TERM.0,5-1,5MM | 200 ad. | | 0,057\$ |
| 014 100 050025 | IIT-2,5 İZOLELİ İĞNE TİP TERM.1,5-2,5MM | 200 ad. | | 0,063\$ |
| 014 100 050040 | IIT-4 İZOLELİ İĞNE TİP TERM.4-6MM | 100 ad. | | 0,124\$ |
| İZOLELİ EK MUF | | | | |
| 014 100 070015 | IEM-1,5 İZOLELİ EK MUF 0,5-1,5 MM | 100 ad. | | 0,063\$ |
| 014 100 070025 | IEM-2,5 İZOLELİ EK MUF 1,5-2,5 MM | 100 ad. | | 0,069\$ |
| 014 100 070040 | IEM-4 İZOLELİ EK MUF 4-6 MM | 100 ad. | | 0,110\$ |
| İZOLELİ FASTON ERKEK TERMİNAL | | | | |
| 014 100 060015 | IFE-1,5 İZO. FASTON ERK. TERM. 1,5 MM | 200 ad. | | 0,110\$ |
| 014 100 060025 | IFE-2,5 İZO. FASTON ERK. TERM. 2,5 MM | 200 ad. | | 0,110\$ |
| 014 100 060040 | IFE-4 İZO. FASTON ERK. TERM. 4 MM | 100 ad. | | 0,160\$ |
| İZOLELİ FASTON DIŞI TERMİNAL | | | | |
| 014 100 080510 | IDT-0,5-1 İZO. FASTON DIŞI TERM. 0,5-1MM | 200 ad. | | 0,110\$ |
| 014 100 081525 | IDT-1,5-2,5 İZO.FASTON DIŞI TERM. 1,5-2,5MM | 200 ad. | | 0,110\$ |
| 014 100 084060 | IDT-4-6 İZO. FASTON DIŞI TERM. 4-6 MM | 100 ad. | | 0,160\$ |
| TAM İZOLELİ DIŞI TERMİNAL | | | | |
| 014 100 090510 | TDT-0,5-1 TAM İZO.DIŞI TERM. 0,5-1 MM | 200 ad. | | 0,110\$ |
| 014 100 091525 | TDT-1,5-2,5 TAM İZO.DIŞI TERM.1,5-2,5 MM | 150 ad. | | 0,110\$ |
| 014 100 094060 | TDT-4-6 TAM İZO.DIŞI TERM. 4-6 MM | 100 ad. | | 0,170\$ |
| YUVARLAK DIŞI TERMİNAL | | | | |
| 014 100 100510 | YDT-0,5-1 YUV. DIŞI TERM. 0,5-1 MM | 200 ad. | | 0,110\$ |
| 014 100 101525 | YDT-1,5-2,5 YUV. DIŞI TERM. 1,5-2,5 MM | 200 ad. | | 0,110\$ |
| 014 100 104060 | YDT-4-6 YUV. DIŞI TERM. 4-6 MM | 100 ad. | | 0,170\$ |
| YUVARLAK ERKEK TERMİNAL | | | | |
| 014 100 110510 | YET-0,5-1 YUV. ERKEK TERM. 0,5-1 MM | 200 ad. | | 0,074\$ |
| 014 100 111525 | YET-1,5-2,5 YUV. ERKEK TERM.1,5-2,5 MM | 200 ad. | | 0,079\$ |
| 014 100 114060 | YET-4-6 YUV. ERKEK TERM. 4-6 MM | 100 ad. | | 0,139\$ |
| FASTON TİP TERMİNALLER İZOLELİ | | | | |
| 065 100 140003 | TSF-1-D 6,3 FASTON TİP TERMİNAL | 200 ad. | | 0,034\$ |
| 065 100 140002 | TSF-1-D MİNİ 4,8 FASTON TİP TERMİNAL | 200 ad. | | 0,043\$ |
| 065 100 140001 | TSF-1-D GÜMÜŞ FASTON TİP TERMİNAL | 200 ad. | | 0,048\$ |
| 065 100 140004 | TSF-1-E FASTON TİP TERMİNAL | 200 ad. | | 0,034\$ |

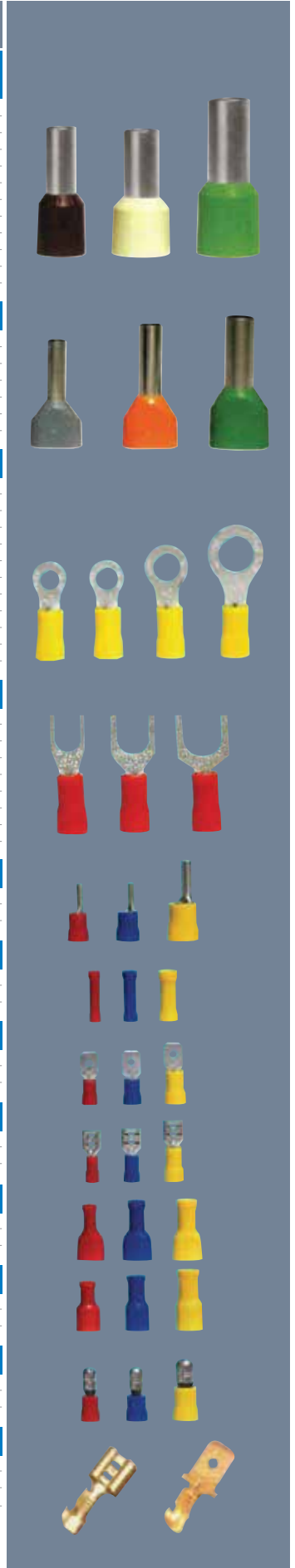

MUTLUSAN SİNYAL ve KUMANDA BUTONLARI



ÜRÜN KODU
010 090 010001
ÜRÜN ADI
10MM KABLOLU
SİNYAL ARMATÜRÜ
AMBALAJ ADET / KOLİ
100
FİYAT
1,538 TL



ÜRÜN KODU
010 090 010010
ÜRÜN ADI
22MM SİNYAL
ARMATÜRÜ 220V
AMBALAJ ADET / KOLİ
24
FİYAT
2,520 TL



ÜRÜN KODU
010 090 040002
ÜRÜN ADI
YAYLI STOP
BUTONU
AMBALAJ ADET / KOLİ
20
FİYAT
6,118 TL



ÜRÜN KODU
010 090 010005
ÜRÜN ADI
14MM SİNYAL
ARMATÜRÜ 12V
AMBALAJ ADET / KOLİ
50
FİYAT
2,084 TL



ÜRÜN KODU
010 090 010002
ÜRÜN ADI
BA9S DUYLU LEDLİ
22MM SİN. ARM. 220V
AMBALAJ ADET / KOLİ
24
FİYAT
6,078 TL



ÜRÜN KODU
010 090 050004
ÜRÜN ADI
BA9S NEON AMPÜLLÜ
YAYLI IŞIKLI STR.BUT.
AMBALAJ ADET / KOLİ
20
FİYAT
10,715 TL



ÜRÜN KODU
010 090 010006
ÜRÜN ADI
14MM SİNYAL
ARMATÜRÜ 24V
AMBALAJ ADET / KOLİ
50
FİYAT
2,084 TL



ÜRÜN KODU
010 090 010003
ÜRÜN ADI
BA9S DUYLU NEON
22MM SİN.ARM. 220V
AMBALAJ ADET / KOLİ
24
FİYAT
3,882 TL



ÜRÜN KODU
010 090 050006
ÜRÜN ADI
BA9S NEON AMPÜLLÜ
YAYLI IŞIKLI STP.BUT.
AMBALAJ ADET / KOLİ
20
FİYAT
10,715 TL



ÜRÜN KODU
010 090 010007
ÜRÜN ADI
14MM SİNYAL
ARMATÜRÜ 220V
AMBALAJ ADET / KOLİ
50
FİYAT
1,786 TL



ÜRÜN KODU
010 090 010004
ÜRÜN ADI
22MM SİNYAL ARM.
220V LEDLİ
AMBALAJ ADET / KOLİ
24
FİYAT
4,876 TL



ÜRÜN KODU
010 090 050003
ÜRÜN ADI
BA9S LEDLİ YAYLI
IŞIKLI START BUTONU
AMBALAJ ADET / KOLİ
20
FİYAT
12,799 TL



ÜRÜN KODU
010 090 010008
ÜRÜN ADI
22MM SİNYAL
ARMATÜRÜ 12V
AMBALAJ ADET / KOLİ
24
FİYAT
2,852 TL



ÜRÜN KODU
010 090 070002
ÜRÜN ADI
22MM SİNYAL
ARMATÜRÜ 24V LEDLİ
AMBALAJ ADET / KOLİ
24
FİYAT
5,722 TL



ÜRÜN KODU
010 090 050005
ÜRÜN ADI
BA9S LEDLİ YAYLI
IŞIKLI STOP BUTONU
AMBALAJ ADET / KOLİ
20
FİYAT
12,799 TL



ÜRÜN KODU
010 090 010009
ÜRÜN ADI
22MM SİNYAL
ARMATÜRÜ 24V
AMBALAJ ADET / KOLİ
24
FİYAT
2,852 TL



ÜRÜN KODU
010 090 040001
ÜRÜN ADI
YAYLI START
BUTONU
AMBALAJ ADET / KOLİ
20
FİYAT
6,118 TL



ÜRÜN KODU
010 090 040005
ÜRÜN ADI
YAYLI MANTAR KAFA
BUTON STOP
AMBALAJ ADET / KOLİ
12
FİYAT
7,772 TL

MUTLUSAN SİNYAL ve KUMANDA BUTONLARI



ÜRÜN KODU
010 090 040003
ÜRÜN ADI
YAYLI MANTAR KAFA
BUTON START
AMBALAJ ADET / KOLİ
12
FİYAT
7,772 TL



ÜRÜN KODU
010 090 050001
ÜRÜN ADI
ACİL STOP BUTONU
(30'LUK)
AMBALAJ ADET / KOLİ
12
FİYAT
11,929 TL



ÜRÜN KODU
010 090 030007
ÜRÜN ADI
SEÇİCİ BUTON 0-1
ANAHTARLI
AMBALAJ ADET / KOLİ
12
FİYAT
25,189 TL



ÜRÜN KODU
010 090 030003
ÜRÜN ADI
BA9S LEDLİ IŞIKLI
SEÇİCİ BUTON 0-1
AMBALAJ ADET / KOLİ
12
FİYAT
15,239 TL



ÜRÜN KODU
010 090 050002
ÜRÜN ADI
ACİL STOP BUTONU
(40'LİK)
AMBALAJ ADET / KOLİ
12
FİYAT
11,929 TL



ÜRÜN KODU
010 090 030008
ÜRÜN ADI
SEÇİCİ BUTON 11-0-1
ANAHTARLI
AMBALAJ ADET / KOLİ
12
FİYAT
27,332 TL



ÜRÜN KODU
010 090 030004
ÜRÜN ADI
BA9S LEDLİ IŞIKLI
SEÇİCİ BUTON 11-0-1
AMBALAJ ADET / KOLİ
12
FİYAT
18,998 TL



ÜRÜN KODU
010 090 040007
ÜRÜN ADI
YAYLI İKİZ
BUTON
AMBALAJ ADET / KOLİ
14
FİYAT
15,241 TL



ÜRÜN KODU
010 090 050007
ÜRÜN ADI
ANAHTARLI ACİL STOP
BUTONU (40'LİK)
AMBALAJ ADET / KOLİ
12
FİYAT
23,812 TL



ÜRÜN KODU
010 090 020002
ÜRÜN ADI
ESKİ TİP START-STOP
BUTONU ÇİFT KONTAK
AMBALAJ ADET / KOLİ
20
FİYAT
5,938 TL



ÜRÜN KODU
010 090 040006
ÜRÜN ADI
YAYLI IŞIKLI İKİZ
BUTON
AMBALAJ ADET / KOLİ
14
FİYAT
18,752 TL



ÜRÜN KODU
010 091 020002
ÜRÜN ADI
YÖN IŞARETLİ START
BUTONU
AMBALAJ ADET / KOLİ
20
FİYAT
7,137 TL



ÜRÜN KODU
010 090 020001
ÜRÜN ADI
ESKİ TİP START
BUTONU TEK KONTAK
AMBALAJ ADET / KOLİ
20
FİYAT
4,750 TL



ÜRÜN KODU
010 090 030001
ÜRÜN ADI
SEÇİCİ BUTON
0-1
AMBALAJ ADET / KOLİ
12
FİYAT
8,370 TL



ÜRÜN KODU
010 111 070001
ÜRÜN ADI
BUZZER 220 VOLT
LEDLİ
AMBALAJ ADET / KOLİ
24
FİYAT
15,758 TL



ÜRÜN KODU
010 090 020003
ÜRÜN ADI
ESKİ TİP STOP BUTONU
TEK KONTAK
AMBALAJ ADET / KOLİ
20
FİYAT
4,750 TL



ÜRÜN KODU
010 090 030002
ÜRÜN ADI
SEÇİCİ BUTON
11-0-1
AMBALAJ ADET / KOLİ
12
FİYAT
12,111 TL



ÜRÜN KODU
010 111 070002
ÜRÜN ADI
BUZZER 24 VOLT
LEDLİ
AMBALAJ ADET / KOLİ
24
FİYAT
14,570 TL

MUTLUSAN SİNYAL ve KUMANDA BUTONLARI



ÜRÜN KODU
010 111 070003
ÜRÜN ADI
BUZZER
220 VOLT
AMBALAJ ADET / KOLİ
24
FİYAT
13,452 TL



ÜRÜN KODU
010 093 000003
ÜRÜN ADI
ACİL DURDURMA
ETİKETİ
AMBALAJ ADET / KOLİ
50
FİYAT
3,902 TL



ÜRÜN KODU
010 093 000002
ÜRÜN ADI
BUTON ETİKETİ
AMBALAJ ADET / KOLİ
50
FİYAT
0,782 TL



ÜRÜN KODU
010 111 070004
ÜRÜN ADI
BUZZER
24 VOLT
AMBALAJ ADET / KOLİ
24
FİYAT
12,334 TL



ÜRÜN KODU
010 090 050008
ÜRÜN ADI
EMNİYET BASMA
DÜĞMESİ MUHAFAZA
AMBALAJ ADET / KOLİ
50
FİYAT
1,471 TL



ÜRÜN KODU
010 093 000004
ÜRÜN ADI
YEDEK KONTAK
BLOK
AMBALAJ ADET / KOLİ
50
FİYAT
3,721 TL



ÜRÜN KODU
010 090 030005
ÜRÜN ADI
BA9S NEON AMPÜLLÜ
IŞIKLI SEÇ.BUT. 0-1
AMBALAJ ADET / KOLİ
12
FİYAT
13,305 TL



ÜRÜN KODU
010 093 000001
ÜRÜN ADI
SİLİKON TOZ
KILIFI
AMBALAJ ADET / KOLİ
50
FİYAT
2,901 TL



ÜRÜN KODU
010 093 000005
ÜRÜN ADI
IŞIK SOKETİ
AMBALAJ ADET / KOLİ
20
FİYAT
3,572 TL



ÜRÜN KODU
010 090 030006
ÜRÜN ADI
BA9S NEON AMPÜLLÜ
IŞIKLI SEÇ.BUT. 11-0-1
AMBALAJ ADET / KOLİ
12
FİYAT
17,025 TL

EUROBOX ETANJ BUTON KUTULARI (YENİ MODEL)

| | | |
|--|---|---|
|  <p>ÜRÜN KODU 010 091 010001 ÜRÜN ADI 1 Lİ ETANJ BUTON KUTUSU AMBALAJ ADET / KOLİ 24 FİYAT 6,548 TL</p> |  <p>ÜRÜN KODU 010 091 010003 ÜRÜN ADI 3 LÜ ETANJ BUTON KUTUSU AMBALAJ ADET / KOLİ 12 FİYAT 11,468 TL</p> |  <p>ÜRÜN KODU 010 090 050009 ÜRÜN ADI TEKLİ ACİL STOPLU KUTU AMBALAJ ADET / KOLİ 18 FİYAT 18,454 TL</p> |
|  <p>ÜRÜN KODU 010 091 010002 ÜRÜN ADI 2 Lİ ETANJ BUTON KUTUSU AMBALAJ ADET / KOLİ 18 FİYAT 8,334 TL</p> |  <p>ÜRÜN KODU 010 091 010004 ÜRÜN ADI 4 LÜ ETANJ BUTON KUTUSU AMBALAJ ADET / KOLİ 10 FİYAT 11,875 TL</p> |  <p>ÜRÜN KODU 010 091 020001 ÜRÜN ADI ASANSÖR REVİZYON 4'LÜ KUTU AMBALAJ ADET / KOLİ 6 FİYAT 50,599 TL</p> |

VİNÇ KUTULARI

| | | |
|--|---|--|
|  <p>ÜRÜN KODU 010 092 000001 ÜRÜN ADI İKİLİ VİNÇ KUTUSU (TEK HIZLI) AMBALAJ ADET / KOLİ 1 FİYAT 50,302 TL</p> |  <p>ÜRÜN KODU 010 092 000003 ÜRÜN ADI DÖRTLÜ VİNÇ KUTUSU (TEK HIZLI) AMBALAJ ADET / KOLİ 1 FİYAT 80,066 TL</p> |  <p>ÜRÜN KODU 010 092 000005 ÜRÜN ADI ALTILI VİNÇ KUTUSU (TEK HIZLI) AMBALAJ ADET / KOLİ 1 FİYAT 119,058 TL</p> |
|  <p>ÜRÜN KODU 010 092 000002 ÜRÜN ADI ÜÇLÜ VİNÇ KUTUSU (TEK HIZLI) AMBALAJ ADET / KOLİ 1 FİYAT 59,529 TL</p> |  <p>ÜRÜN KODU 010 092 000004 ÜRÜN ADI BEŞLİ VİNÇ KUTUSU (TEK HIZLI) AMBALAJ ADET / KOLİ 1 FİYAT 89,293 TL</p> |  <p>ÜRÜN KODU 010 092 000006 ÜRÜN ADI YEDİLİ VİNÇ KUTUSU (TEK HIZLI) AMBALAJ ADET / KOLİ 1 FİYAT 127,094 TL</p> |

Güneş Enerjili SOLAR İkaz Lambası



2 yıl garantili
Rf dalgaya yaymaz
Stabilize ışık çıkışı
12 yıl uzun ömürlü
Uv ışınlarına karşı dayanıklı
Görünebilirlik mesafesi 10 km
Her türlü yüzeye kolay montaj
Sabit, flaşör, çakar, döner çalışma fonksiyonları
Foto sensör yardımıyla gece ve gündüz algılama

007 087 400105



007 087 400108



007 087 400107

İL-X SERİSİ Ø90mm GÜNEŞ ENERJİ "SOLAR PANEL" İKAZ LAMBALARI

| ÜRÜN KODU | ÇALIŞMA ŞEKLİ | BESLEME GERİLİMİ | MODEL | FİYAT |
|-----------|---------------|------------------|-------|-------|
|-----------|---------------|------------------|-------|-------|

T100 SOLAR İKAZ LAMBASI

| | | | | |
|----------------|-------|-----|------------------|------------|
| 007 087 400106 | ÇAKAR | 12V | İL-XSLR-912V-TMK | 160,000 \$ |
|----------------|-------|-----|------------------|------------|

T100 SOLAR KULE İKAZ LAMBASI SETİ

| | | | | |
|----------------|-------|-----|---------------|------------|
| 007 087 400107 | ÇAKAR | 12V | İL-XSL05M-TMK | 350,000 \$ |
|----------------|-------|-----|---------------|------------|

T120 SOLAR AYAKLI İKAZ LAMBASI SETİ

| | | | | |
|----------------|-------|-----|---------------|------------|
| 007 087 400108 | ÇAKAR | 12V | İL-XSL20M-KMK | 500,000 \$ |
|----------------|-------|-----|---------------|------------|



İL-X...VT9 SERİSİ MULTİ VE ŞARJLI İKAZ LAMBALARI

| ÜRÜN KODU | ÇALIŞMA ŞEKLİ | BESLEME GERİLİMİ | MODEL | FİYAT |
|-----------|---------------|------------------|-------|-------|
|-----------|---------------|------------------|-------|-------|

T90 MULTİ SERİ TEK GÖVDE 4 FARKLI ÇALIŞMA ÖZELLİĞİ

| | | | | |
|----------------|--------------|--------|------------------|-----------|
| 007 087 400101 | Multi | 24VDC | İL-XLM-VT9-24K | 42,000 \$ |
| 007 087 400102 | Multi | 220VAC | İL-XLM-VT9-220K | 48,000 \$ |
| 007 087 400103 | Multi+Buzzer | 24VAC | İL-XLMB-VT9-24K | 42,000 \$ |
| 007 087 400104 | Multi+Buzzer | 220VAC | İL-XLMB-VT9-220K | 48,000 \$ |

T90 ŞARJLI SERİ TEK GÖVDE 4 FARKLI ÇALIŞMA ÖZELLİĞİ

| | | | | |
|----------------|-------|-----|----------------|------------|
| 007 087 400105 | Multi | 12V | İL-XJM-MM9-12K | 150,000 \$ |
|----------------|-------|-----|----------------|------------|

T90 PİLLİ SERİ TEK GÖVDE 4 FARKLI ÇALIŞMA ÖZELLİĞİ

| | | | | |
|----------------|-------|-----|----------------|------------|
| 007 087 400109 | Multi | 12V | İL-XPM-MM9-12K | 150,000 \$ |
|----------------|-------|-----|----------------|------------|

MULTİ Serisi Standart ve Şarjlı İkaz Lambaları



007 087 400101



007 087 400105

2 yıl garantili
Stabilize ışık çıkışı
Her türlü yüzeye kolay montaj
Sabit, flaşör, çakar ve döner çalışma fonksiyonları

RENKLER

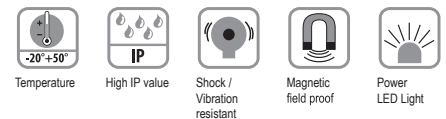

IL-X....VT6 SERİSİ TEK GÖVDE'DE 5 RENK İKAZ LAMBALARI

| ÜRÜN KODU | ÇALIŞMA ŞEKLİ | BESLEME GERİLİMİ | MODEL | FİYAT |
|--|---------------|------------------|--------------------|-----------|
| IL-XP..-VT6 Serisi İkaz Lambaları | | | | |
| 129 087 000431 | Sabit Işıklı | 24VDC | IL-XLS-VT6-243-A2 | 42,353 \$ |
| 129 087 000432 | Sabit Işıklı | 220VAC | IL-XLS-VT6-2203-A2 | 47,647 \$ |
| 129 087 000433 | Flaşörlü | 24VDC | IL-XLF-VT6-243-A2 | 47,647 \$ |
| 129 087 000434 | Flaşörlü | 220VAC | IL-XLF-VT6-2203-A2 | 52,941 \$ |
| 129 087 000435 | Çakar | 24VDC | IL-XLÇ-VT6-243-A2 | 52,941 \$ |
| 129 087 000436 | Çakar | 220VAC | IL-XLÇ-VT6-2203-A2 | 58,235 \$ |

IL-XP..-VT6 Serisi Buzzerli İkaz Lambaları

| | | | | |
|----------------|--|--------|---------------------|-----------|
| 129 087 000412 | Sabit Işıklı +Buzzer | 24VDC | IL-XLSB-VT6-243-A2 | 47,647 \$ |
| 129 087 000413 | Sabit Işıklı +Buzzer | 220VAC | IL-XLSB-VT6-2203-A2 | 52,941 \$ |
| 129 087 000414 | Flaşörlü +Buzzer | 24VDC | IL-XLFB-VT6-243-A2 | 52,941 \$ |
| 129 087 000415 | Flaşörlü +Buzzer | 220VAC | IL-XLFB-VT6-2203-A2 | 58,235 \$ |
| 129 087 000416 | Çakar +Buzzer | 24VDC | IL-XLÇB-VT6-243-A2 | 58,235 \$ |
| 129 087 000417 | Çakar +Buzzer | 220VAC | IL-XLÇB-VT6-2203-A2 | 63,529 \$ |
| 129 087 000418 | Konnektörlü tipler için güç konnektörü | | IL-XM125 | 21,176 \$ |

NOT: Rekor montajlı ürün taleplerinizde yukarıda belirtilen kodlarda yer alan VT6 yerine VR6 getirerek ürün seçimi yapabilirsiniz. Fiyat değişmez.

IL-X....F7 SERİSİ 12... 80 V/DC MOBİL UYGULAMA İCİN İKAZ LAMBALARI

| ÜRÜN KODU | ÇALIŞMA ŞEKLİ | BESLEME GERİLİMİ | MODEL | FİYAT |
|---|---------------|------------------|-----------------|-----------|
| IL-XP..-F7 Serisi İkaz Lambaları | | | | |
| 129 087 000419 | Sabit Işıklı | 12...80VDC | IL-XS-F7-80-A2 | 42,353 \$ |
| 129 087 000420 | Sabit Işıklı | 220VAC | IL-XS-F7-220-A2 | 47,647 \$ |
| 129 087 000421 | Flaşörlü | 12...80VDC | IL-XF-F7-80-A2 | 47,647 \$ |
| 129 087 000422 | Flaşörlü | 220VAC | IL-XF-F7-220-A2 | 52,941 \$ |
| 129 087 000423 | Çakar | 12...80VDC | IL-XÇ-F7-80-A2 | 52,941 \$ |
| 129 087 000424 | Çakar | 220VAC | IL-XÇ-F7-220-A2 | 58,235 \$ |

IL-XP..-F7 Serisi Buzzerli İkaz Lambaları

| | | | | |
|----------------|----------------------|------------|------------------|-----------|
| 129 087 000425 | Sabit Işıklı +Buzzer | 12...80VDC | IL-XSB-F7-80-A2 | 47,647 \$ |
| 129 087 000426 | Sabit Işıklı +Buzzer | 220VAC | IL-XSB-F7-220-A2 | 52,941 \$ |
| 129 087 000427 | Flaşörlü +Buzzer | 12...80VDC | IL-XFB-F7-80-A2 | 52,941 \$ |
| 129 087 000428 | Flaşörlü +Buzzer | 220VAC | IL-XFB-F7-220-A2 | 58,235 \$ |
| 129 087 000429 | Çakar +Buzzer | 12...80VDC | IL-XÇB-F7-80-A2 | 58,235 \$ |
| 129 087 000430 | Çakar +Buzzer | 220VAC | IL-XÇB-F7-220-A2 | 63,529 \$ |



Temperature



High IP value



Shock /
Vibration
resistant



Magnetic
field proof



Power
LED Light

İşıklı kolonlarda kırmızı sabit renktir. Diğer renkler siparişle yapılabilmektedir.



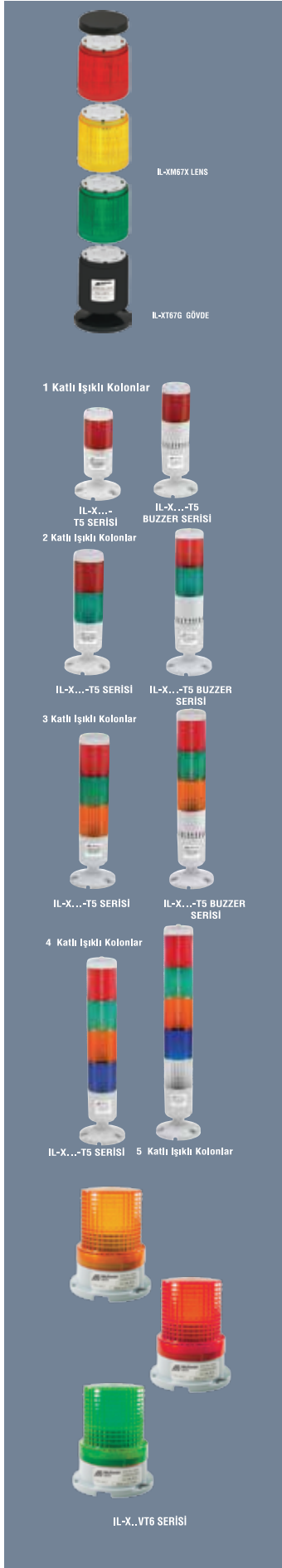
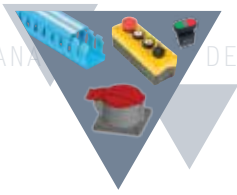

| Kod | Açıklama / Stok Cinsi | Çalışma Şekli | Montaj Şekli | Besleme Gerilimi | Amb. Birimi | FİYAT |
|--|-----------------------|---------------|---------------|------------------|-------------|-----------|
| İL-XM67 SERİSİ Q67 MODÜLER SİSTEM İKAZ LAMBA LENSLERİ | | | | | | |
| 129 087 000015 | İL-XM67S-24 | SABİT İŞİK | TABANA MONTAJ | 24V AC/DC | 1 ad. | 46,080 \$ |
| 129 087 000018 | İL-XM67S-220 | SABİT İŞİK | TABANA MONTAJ | 220V AC | 1 ad. | 55,928 \$ |
| 129 087 000020 | İL-XM67F-24 | FLAŞÖRLÜ | TABANA MONTAJ | 24V AC/DC | 1 ad. | 55,549 \$ |
| 129 087 000023 | İL-XM67F-220 | FLAŞÖRLÜ | TABANA MONTAJ | 220V AC | 1 ad. | 55,549 \$ |
| 129 087 000025 | İL-XM67Ç-24 | ÇAKAR | TABANA MONTAJ | 24V AC/DC | 1 ad. | 65,650 \$ |
| 129 087 000028 | İL-XM67Ç-220 | ÇAKAR | TABANA MONTAJ | 220V AC | 1 ad. | 65,650 \$ |
| 129 087 000030 | İL-XM67D-24 | DÖNER | TABANA MONTAJ | 24V AC/DC | 1 ad. | 65,650 \$ |
| 129 087 000033 | İL-XM67D-220 | DÖNER | TABANA MONTAJ | 220V AC | 1 ad. | 65,650 \$ |
| 129 087 000035 | İL-XM67B-24 | BUZZER | TABANA MONTAJ | 24V AC/DC | 1 ad. | 36,613 \$ |
| 129 087 000038 | İL-XM67B-220 | BUZZER | TABANA MONTAJ | 220V AC | 1 ad. | 36,613 \$ |
| 129 087 000039 | İL-XT67-G | GÖVDE | | | 1 ad. | 28,406 \$ |

| İL-X.T5 SERİSİ Q 52 1 KATLI İŞIKLI KOLONLAR | | | | | | |
|--|-----------------|-------------------|---------------|---------|-------|-----------|
| 129 087 000278 | İL-XLS-T5-241 | SABİT İŞİK | TABANA MONTAJ | 24V DC | 1 ad. | 31,562 \$ |
| 129 087 000279 | İL-XLS-T5-2201 | SABİT İŞİK | TABANA MONTAJ | 220V AC | 1 ad. | 37,874 \$ |
| 129 087 000281 | İL-XLF-T5-241 | FLAŞÖRLÜ | TABANA MONTAJ | 24V DC | 1 ad. | 47,975 \$ |
| 129 087 000282 | İL-XLF-T5-2201 | FLAŞÖRLÜ | TABANA MONTAJ | 220V AC | 1 ad. | 51,763 \$ |
| 129 087 000284 | İL-XÇ-T5-241 | ÇAKAR | TABANA MONTAJ | 24V DC | 1 ad. | 44,187 \$ |
| 129 087 000285 | İL-XÇ-T5-2201 | ÇAKAR | TABANA MONTAJ | 220V AC | 1 ad. | 50,500 \$ |
| 129 087 000287 | İL-XLSB-T5-241 | SABİT İŞİK+BUZZER | TABANA MONTAJ | 24V DC | 1 ad. | 50,500 \$ |
| 129 087 000288 | İL-XLSB-T5-2201 | SABİT İŞİK+BUZZER | TABANA MONTAJ | 220V AC | 1 ad. | 56,812 \$ |
| 129 087 000290 | İL-XLFB-T5-241 | FLAŞÖRLÜ+BUZZER | TABANA MONTAJ | 24V DC | 1 ad. | 60,600 \$ |
| 129 087 000291 | İL-XLFB-T5-2201 | FLAŞÖRLÜ+BUZZER | TABANA MONTAJ | 220V AC | 1 ad. | 66,912 \$ |
| 129 087 000293 | İL-XÇB-T5-244 | ÇAKAR+BUZZER | TABANA MONTAJ | 24V DC | 1 ad. | 56,812 \$ |
| 129 087 000294 | İL-XÇB-T5-2204 | ÇAKAR+BUZZER | TABANA MONTAJ | 220V AC | 1 ad. | 63,125 \$ |

| İL-X.T5 SERİSİ Q 52 2 KATLI İŞIKLI KOLONLAR | | | | | | |
|--|-----------------|-------------------|---------------|---------|-------|-----------|
| 129 087 000296 | İL-XLS-T5-242 | SABİT İŞİK | TABANA MONTAJ | 24V DC | 1 ad. | 44,187 \$ |
| 129 087 000297 | İL-XLS-T5-2202 | SABİT İŞİK | TABANA MONTAJ | 220V AC | 1 ad. | 47,343 \$ |
| 129 087 000299 | İL-XLF-T5-242 | FLAŞÖRLÜ | TABANA MONTAJ | 24V DC | 1 ad. | 53,025 \$ |
| 129 087 000300 | İL-XLF-T5-2202 | FLAŞÖRLÜ | TABANA MONTAJ | 220V AC | 1 ad. | 63,125 \$ |
| 129 087 000302 | İL-XLSB-T5-242 | SABİT İŞİK+BUZZER | TABANA MONTAJ | 24V DC | 1 ad. | 58,074 \$ |
| 129 087 000303 | İL-XLSB-T5-2202 | SABİT İŞİK+BUZZER | TABANA MONTAJ | 220V AC | 1 ad. | 64,387 \$ |
| 129 087 000305 | İL-XLFB-T5-242 | FLAŞÖRLÜ+BUZZER | TABANA MONTAJ | 24V DC | 1 ad. | 65,650 \$ |
| 129 087 000306 | İL-XLFB-T5-2202 | FLAŞÖRLÜ+BUZZER | TABANA MONTAJ | 220V AC | 1 ad. | 71,962 \$ |

| İL-X.T5 SERİSİ Q 52 3 KATLI İŞIKLI KOLONLAR | | | | | | |
|--|-----------------|-------------------|---------------|---------|-------|-----------|
| 129 087 000308 | İL-XLS-T5-243 | SABİT İŞİK | TABANA MONTAJ | 24V DC | 1 ad. | 47,343 \$ |
| 129 087 000309 | İL-XLS-T5-2203 | SABİT İŞİK | TABANA MONTAJ | 220V AC | 1 ad. | 50,500 \$ |
| 129 087 000311 | İL-XLF-T5-243 | FLAŞÖRLÜ | TABANA MONTAJ | 24V DC | 1 ad. | 60,600 \$ |
| 129 087 000312 | İL-XLF-T5-2203 | FLAŞÖRLÜ | TABANA MONTAJ | 220V AC | 1 ad. | 66,912 \$ |
| 129 087 000314 | İL-XLSB-T5-243 | SABİT İŞİK+BUZZER | TABANA MONTAJ | 24V DC | 1 ad. | 73,224 \$ |
| 129 087 000315 | İL-XLSB-T5-2203 | SABİT İŞİK+BUZZER | TABANA MONTAJ | 220V AC | 1 ad. | 79,537 \$ |
| 129 087 000317 | İL-XLFB-T5-243 | FLAŞÖRLÜ+BUZZER | TABANA MONTAJ | 24V DC | 1 ad. | 79,537 \$ |
| 129 087 000318 | İL-XLFB-T5-2203 | FLAŞÖRLÜ+BUZZER | TABANA MONTAJ | 220V AC | 1 ad. | 85,849 \$ |

| İL-X.T5 SERİSİ Q 52 4 KATLI İŞIKLI KOLONLAR | | | | | | |
|--|-----------------|-------------------|---------------|---------|-------|------------|
| 129 087 000254 | İL-XLS-T5-244 | SABİT İŞİK | TABANA MONTAJ | 24V DC | 1 ad. | 53,656 \$ |
| 129 087 000255 | İL-XLS-T5-2204 | SABİT İŞİK | TABANA MONTAJ | 220V AC | 1 ad. | 63,125 \$ |
| 129 087 000257 | İL-XLF-T5-244 | FLAŞÖRLÜ | TABANA MONTAJ | 24V DC | 1 ad. | 69,437 \$ |
| 129 087 000258 | İL-XLF-T5-2204 | FLAŞÖRLÜ | TABANA MONTAJ | 220V AC | 1 ad. | 78,275 \$ |
| 129 087 000260 | İL-XLSB-T5-244 | SABİT İŞİK+BUZZER | TABANA MONTAJ | 24V DC | 1 ad. | 82,062 \$ |
| 129 087 000261 | İL-XLSB-T5-2204 | SABİT İŞİK+BUZZER | TABANA MONTAJ | 220V AC | 1 ad. | 90,899 \$ |
| 129 087 000263 | İL-XLFB-T5-244 | FLAŞÖRLÜ+BUZZER | TABANA MONTAJ | 24V DC | 1 ad. | 90,899 \$ |
| 129 087 000264 | İL-XLFB-T5-2204 | FLAŞÖRLÜ+BUZZER | TABANA MONTAJ | 220V AC | 1 ad. | 100,999 \$ |

| İL-X.T5 SERİSİ Q 52 5 KATLI İŞIKLI KOLONLAR | | | | | | |
|--|-----------------|-------------------|---------------|---------|-------|------------|
| 129 087 000266 | İL-XLS-T5-245 | SABİT İŞİK | TABANA MONTAJ | 24V DC | 1 ad. | 58,074 \$ |
| 129 087 000267 | İL-XLS-T5-2205 | SABİT İŞİK | TABANA MONTAJ | 220V AC | 1 ad. | 68,175 \$ |
| 129 087 000269 | İL-XLF-T5-245 | FLAŞÖRLÜ | TABANA MONTAJ | 24V DC | 1 ad. | 75,750 \$ |
| 129 087 000270 | İL-XLF-T5-2205 | FLAŞÖRLÜ | TABANA MONTAJ | 220V AC | 1 ad. | 98,475 \$ |
| 129 087 000272 | İL-XLSB-T5-245 | SABİT İŞİK+BUZZER | TABANA MONTAJ | 24V DC | 1 ad. | 88,374 \$ |
| 129 087 000273 | İL-XLSB-T5-2205 | SABİT İŞİK+BUZZER | TABANA MONTAJ | 220V AC | 1 ad. | 98,475 \$ |
| 129 087 000275 | İL-XLFB-T5-245 | FLAŞÖRLÜ+BUZZER | TABANA MONTAJ | 24V DC | 1 ad. | 100,999 \$ |
| 129 087 000276 | İL-XLFB-T5-2205 | FLAŞÖRLÜ+BUZZER | TABANA MONTAJ | 220V AC | 1 ad. | 113,625 \$ |

| İL-X.VT6 SERİSİ Q60 İKAZ LAMBALARI | | | | | | |
|---|------------------|--------------------|---------------|---------|-------|-----------|
| 129 087 000040 | İL-XLS-VT6-24K | SABİT İŞİK | TABANA MONTAJ | 24V DC | 1 ad. | 44,187 \$ |
| 129 087 000041 | İL-XLS-VT6-220K | SABİT İŞİK | TABANA MONTAJ | 220V AC | 1 ad. | 50,500 \$ |
| 129 087 000043 | İL-XLF-VT6-24K | FLAŞÖRLÜ | TABANA MONTAJ | 24V DC | 1 ad. | 54,287 \$ |
| 129 087 000044 | İL-XLF-VT6-220K | FLAŞÖRLÜ | TABANA MONTAJ | 220V AC | 1 ad. | 61,862 \$ |
| 129 087 000046 | İL-XÇ-VT6-24K | ÇAKAR | TABANA MONTAJ | 24V DC | 1 ad. | 73,224 \$ |
| 129 087 000047 | İL-XÇ-VT6-220K | ÇAKAR | TABANA MONTAJ | 220V AC | 1 ad. | 73,224 \$ |
| 129 087 000050 | İL-XLD-VT6-24K | LEDLİ DÖNER | TABANA MONTAJ | 24V DC | 1 ad. | 66,912 \$ |
| 129 087 000051 | İL-XLD-VT6-220K | LEDLİ DÖNER | TABANA MONTAJ | 220V AC | 1 ad. | 75,750 \$ |
| 129 087 000053 | İL-XLSB-VT6-24K | SABİT İŞİK+BUZZER | TABANA MONTAJ | 24V DC | 1 ad. | 56,812 \$ |
| 129 087 000054 | İL-XLSB-VT6-220K | SABİT İŞİK+BUZZER | TABANA MONTAJ | 220V AC | 1 ad. | 63,125 \$ |
| 129 087 000056 | İL-XLFB-VT6-24K | FLAŞÖRLÜ+BUZZER | TABANA MONTAJ | 24V DC | 1 ad. | 63,125 \$ |
| 129 087 000057 | İL-XLFB-VT6-220K | FLAŞÖRLÜ+BUZZER | TABANA MONTAJ | 220V AC | 1 ad. | 69,437 \$ |
| 129 087 000059 | İL-XÇB-VT6-24K | ÇAKAR+BUZZER | TABANA MONTAJ | 24V DC | 1 ad. | 94,687 \$ |
| 129 087 000060 | İL-XÇB-VT6-220K | ÇAKAR+BUZZER | TABANA MONTAJ | 220V AC | 1 ad. | 94,687 \$ |
| 129 087 000062 | İL-XLDB-VT6-24K | LEDLİ DÖNER+BUZZER | TABANA MONTAJ | 24V DC | 1 ad. | 80,800 \$ |
| 129 087 000063 | İL-XLDB-VT6-220K | LEDLİ DÖNER+BUZZER | TABANA MONTAJ | 220V AC | 1 ad. | 88,374 \$ |

RENK SEÇENEKLERİ: İL-XM67S-12K ● İL-XM67S-12S ● İL-XM67S-12Y ● İL-XM67S-12M ● İL-XM67S-12B ○

İşikli kolonlarda kırmızı sabit renktir. Diğer renkler siparişle yapılabilmektedir.



| Kod | Açıklama / Stok Cinsi | Çalışma Şekli | Montaj Şekli | Besleme Gerilimi | Amb. Birimi | FİYAT |
|--|-----------------------|--------------------|-----------------|------------------|-------------|----------|
| İL-XV8 SERİSİ Q 84 İKAZ LAMBALARI | | | | | | |
| 129 087 000065 | İL-XLS-V8-24K | SABİT İŞİK | VIDALI BAĞLANTI | 24V DC | 1 ad. | 50,500\$ |
| 129 087 000066 | İL-XLS-V8-220K | SABİT İŞİK | VIDALI BAĞLANTI | 220V AC | 1 ad. | 56,812\$ |
| 129 087 000068 | İL-XLF-V8-24K | FLAŞÖR | VIDALI BAĞLANTI | 24V DC | 1 ad. | 53,782\$ |
| 129 087 000069 | İL-XLF-V8-220K | FLAŞÖR | VIDALI BAĞLANTI | 220V AC | 1 ad. | 60,094\$ |
| 129 087 000071 | İL-XÇ-V8-24K | ÇAKAR | VIDALI BAĞLANTI | 24V DC | 1 ad. | 50,500\$ |
| 129 087 000072 | İL-XÇ-V8-220K | ÇAKAR | VIDALI BAĞLANTI | 220V AC | 1 ad. | 56,812\$ |
| 129 087 000075 | İL-XLD-V8-24K | LEDLİ DÖNER | VIDALI BAĞLANTI | 24V DC | 1 ad. | 63,125\$ |
| 129 087 000076 | İL-XLD-V8-220K | LEDLİ DÖNER | VIDALI BAĞLANTI | 220V AC | 1 ad. | 69,437\$ |
| 129 087 000078 | İL-XLSB-V8-24K | SABİT İŞİK+BUZZER | VIDALI BAĞLANTI | 24V DC | 1 ad. | 53,656\$ |
| 129 087 000079 | İL-XLSB-V8-220K | SABİT İŞİK+BUZZER | VIDALI BAĞLANTI | 220V AC | 1 ad. | 59,969\$ |
| 129 087 000081 | İL-XLFB-V8-24K | FLAŞÖRLÜ+BUZZER | VIDALI BAĞLANTI | 24V DC | 1 ad. | 56,812\$ |
| 129 087 000082 | İL-XLFB-V8-220K | FLAŞÖRLÜ+BUZZER | VIDALI BAĞLANTI | 220V AC | 1 ad. | 63,125\$ |
| 129 087 000084 | İL-XÇB-V8-24K | ÇAKAR+BUZZER | VIDALI BAĞLANTI | 24V DC | 1 ad. | 63,125\$ |
| 129 087 000085 | İL-XÇB-V8-220K | ÇAKAR+BUZZER | VIDALI BAĞLANTI | 220V AC | 1 ad. | 69,437\$ |
| 129 087 000087 | İL-XLDB-V8-24K | LEDLİ DÖNER+BUZZER | VIDALI BAĞLANTI | 24V DC | 1 ad. | 79,537\$ |
| 129 087 000088 | İL-XLDB-V8-220K | LEDLİ DÖNER+BUZZER | VIDALI BAĞLANTI | 220V AC | 1 ad. | 85,849\$ |

| | | | | | | |
|---|-----------------|--------------------|-----------------|---------|-------|----------|
| SABİT İŞİKLİ İL-X-T8 SERİSİ İKAZ LAMBALARI | | | | | | |
| 129 087 000090 | İL-XLS-T8-24K | SABİT İŞİK | VIDALI BAĞLANTI | 24V DC | 1 ad. | 50,500\$ |
| 129 087 000091 | İL-XLS-T8-220K | SABİT İŞİK | VIDALI BAĞLANTI | 220V AC | 1 ad. | 56,812\$ |
| 129 087 000093 | İL-XLF-T8-24K | FLAŞÖR | VIDALI BAĞLANTI | 24V DC | 1 ad. | 53,782\$ |
| 129 087 000094 | İL-XLF-T8-220K | FLAŞÖR | VIDALI BAĞLANTI | 220V AC | 1 ad. | 60,094\$ |
| 129 087 000096 | İL-XÇ-T8-24K | ÇAKAR | VIDALI BAĞLANTI | 24V DC | 1 ad. | 50,500\$ |
| 129 087 000097 | İL-XÇ-T8-220K | ÇAKAR | VIDALI BAĞLANTI | 220V AC | 1 ad. | 56,812\$ |
| 129 087 000100 | İL-XLD-T8-24K | LEDLİ DÖNER | VIDALI BAĞLANTI | 24V DC | 1 ad. | 63,125\$ |
| 129 087 000101 | İL-XLD-T8-220K | LEDLİ DÖNER | VIDALI BAĞLANTI | 220V AC | 1 ad. | 69,437\$ |
| 129 087 000103 | İL-XLSB-T8-24K | SABİT İŞİK+BUZZER | VIDALI BAĞLANTI | 24V DC | 1 ad. | 53,656\$ |
| 129 087 000104 | İL-XLSB-T8-220K | SABİT İŞİK+BUZZER | VIDALI BAĞLANTI | 220V AC | 1 ad. | 59,969\$ |
| 129 087 000106 | İL-XLFB-T8-24K | FLAŞÖRLÜ+BUZZER | VIDALI BAĞLANTI | 24V DC | 1 ad. | 56,812\$ |
| 129 087 000107 | İL-XLFB-T8-220K | FLAŞÖRLÜ+BUZZER | VIDALI BAĞLANTI | 220V AC | 1 ad. | 63,125\$ |
| 129 087 000109 | İL-XÇB-T8-24K | ÇAKAR+BUZZER | VIDALI BAĞLANTI | 24V DC | 1 ad. | 63,125\$ |
| 129 087 000110 | İL-XÇB-T8-220K | ÇAKAR+BUZZER | VIDALI BAĞLANTI | 220V AC | 1 ad. | 69,437\$ |
| 129 087 000112 | İL-XLDB-T8-24K | LEDLİ DÖNER+BUZZER | VIDALI BAĞLANTI | 24V DC | 1 ad. | 79,537\$ |
| 129 087 000113 | İL-XLDB-T8-220K | LEDLİ DÖNER+BUZZER | VIDALI BAĞLANTI | 220V AC | 1 ad. | 85,849\$ |

| | | | | | | |
|--|------------------|--------------------|-----------------|---------|-------|----------|
| İL-X-VT8 SERİSİ Q 84 İKAZ LAMBALARI | | | | | | |
| 129 087 000115 | İL-XLS-VT8-24K | SABİT İŞİK | VIDALI BAĞLANTI | 24V DC | 1 ad. | 50,500\$ |
| 129 087 000116 | İL-XLS-VT8-220K | SABİT İŞİK | VIDALI BAĞLANTI | 220V AC | 1 ad. | 56,812\$ |
| 129 087 000118 | İL-XLF-VT8-24K | FLAŞÖR | VIDALI BAĞLANTI | 24V DC | 1 ad. | 53,782\$ |
| 129 087 000119 | İL-XLF-VT8-220K | FLAŞÖR | VIDALI BAĞLANTI | 220V AC | 1 ad. | 60,094\$ |
| 129 087 000121 | İL-XÇ-VT8-24K | ÇAKAR | VIDALI BAĞLANTI | 24V DC | 1 ad. | 50,500\$ |
| 129 087 000122 | İL-XÇ-VT8-220K | ÇAKAR | VIDALI BAĞLANTI | 220V AC | 1 ad. | 56,812\$ |
| 129 087 000125 | İL-XLD-VT8-24K | LEDLİ DÖNER | VIDALI BAĞLANTI | 24V DC | 1 ad. | 63,125\$ |
| 129 087 000126 | İL-XLD-VT8-220K | LEDLİ DÖNER | VIDALI BAĞLANTI | 220V AC | 1 ad. | 69,437\$ |
| 129 087 000128 | İL-XLSB-VT8-24K | SABİT İŞİK+BUZZER | VIDALI BAĞLANTI | 24V DC | 1 ad. | 53,656\$ |
| 129 087 000129 | İL-XLSB-VT8-220K | SABİT İŞİK+BUZZER | VIDALI BAĞLANTI | 220V AC | 1 ad. | 59,969\$ |
| 129 087 000131 | İL-XLFB-VT8-24K | FLAŞÖRLÜ+BUZZER | VIDALI BAĞLANTI | 24V DC | 1 ad. | 56,812\$ |
| 129 087 000132 | İL-XLFB-VT8-220K | FLAŞÖRLÜ+BUZZER | VIDALI BAĞLANTI | 220V AC | 1 ad. | 63,125\$ |
| 129 087 000134 | İL-XÇB-VT8-24K | ÇAKAR+BUZZER | VIDALI BAĞLANTI | 24V DC | 1 ad. | 63,125\$ |
| 129 087 000135 | İL-XÇB-VT8-220K | ÇAKAR+BUZZER | VIDALI BAĞLANTI | 220V AC | 1 ad. | 69,437\$ |
| 129 087 000137 | İL-XLDB-VT8-24K | LEDLİ DÖNER+BUZZER | VIDALI BAĞLANTI | 24V DC | 1 ad. | 79,537\$ |
| 129 087 000138 | İL-XLDB-VT8-220K | LEDLİ DÖNER+BUZZER | VIDALI BAĞLANTI | 220V AC | 1 ad. | 85,849\$ |

| | | | | | | |
|--|-------------------|--------------------|-----------------|---------|-------|-----------|
| İL-X-VT10 SERİSİ Q 100 İKAZ LAMBALARI | | | | | | |
| 129 087 000140 | İL-XLS-VT10-24K | SABİT İŞİK | VIDALI BAĞLANTI | 24V DC | 1 ad. | 66,281\$ |
| 129 087 000141 | İL-XLS-VT10-220K | SABİT İŞİK | VIDALI BAĞLANTI | 220V AC | 1 ad. | 72,594\$ |
| 129 087 000143 | İL-XLF-VT10-24K | FLAŞÖR | VIDALI BAĞLANTI | 24V DC | 1 ad. | 75,750\$ |
| 129 087 000144 | İL-XLF-VT10-220K | FLAŞÖR | VIDALI BAĞLANTI | 220V AC | 1 ad. | 85,534\$ |
| 129 087 000146 | İL-XÇ-VT10-24K | ÇAKAR | VIDALI BAĞLANTI | 24V DC | 1 ad. | 87,112\$ |
| 129 087 000147 | İL-XÇ-VT10-220K | ÇAKAR | VIDALI BAĞLANTI | 220V AC | 1 ad. | 99,736\$ |
| 129 087 000150 | İL-XLD-VT10-24K | LEDLİ DÖNER | VIDALI BAĞLANTI | 24V DC | 1 ad. | 87,112\$ |
| 129 087 000151 | İL-XLD-VT10-220K | LEDLİ DÖNER | VIDALI BAĞLANTI | 220V AC | 1 ad. | 99,736\$ |
| 129 087 000153 | İL-XLSB-VT10-24K | SABİT İŞİK+BUZZER | VIDALI BAĞLANTI | 24V DC | 1 ad. | 65,650\$ |
| 129 087 000154 | İL-XLSB-VT10-220K | SABİT İŞİK+BUZZER | VIDALI BAĞLANTI | 220V AC | 1 ad. | 75,750\$ |
| 129 087 000156 | İL-XLFB-VT10-24K | FLAŞÖRLÜ+BUZZER | VIDALI BAĞLANTI | 24V DC | 1 ad. | 79,537\$ |
| 129 087 000157 | İL-XLFB-VT10-220K | FLAŞÖRLÜ+BUZZER | VIDALI BAĞLANTI | 220V AC | 1 ad. | 92,162\$ |
| 129 087 000159 | İL-XÇB-VT10-24K | ÇAKAR+BUZZER | VIDALI BAĞLANTI | 24V DC | 1 ad. | 138,874\$ |
| 129 087 000160 | İL-XÇB-VT10-220K | ÇAKAR+BUZZER | VIDALI BAĞLANTI | 220V AC | 1 ad. | 151,499\$ |
| 129 087 000162 | İL-XLDB-VT10-24K | LEDLİ DÖNER+BUZZER | VIDALI BAĞLANTI | 24V DC | 1 ad. | 108,574\$ |
| 129 087 000163 | İL-XLDB-VT10-220K | LEDLİ DÖNER+BUZZER | VIDALI BAĞLANTI | 220V AC | 1 ad. | 121,199\$ |

| | | | | | | |
|--|-------------------|--------------------|-----------------|---------|-------|-----------|
| İL-X-VT12 SERİSİ Q 120 İKAZ LAMBALARI | | | | | | |
| 129 087 000165 | İL-XLS-VT12-24K | SABİT İŞİK | VIDALI BAĞLANTI | 24V DC | 1 ad. | 100,999\$ |
| 129 087 000166 | İL-XLS-VT12-220K | SABİT İŞİK | VIDALI BAĞLANTI | 220V AC | 1 ad. | 113,625\$ |
| 129 087 000168 | İL-XLF-VT12-24K | FLAŞÖR | VIDALI BAĞLANTI | 24V DC | 1 ad. | 100,999\$ |
| 129 087 000169 | İL-XLF-VT12-220K | FLAŞÖR | VIDALI BAĞLANTI | 220V AC | 1 ad. | 113,625\$ |
| 129 087 000171 | İL-XÇ-VT12-24K | ÇAKAR | VIDALI BAĞLANTI | 24V DC | 1 ad. | 100,999\$ |
| 129 087 000172 | İL-XÇ-VT12-220K | ÇAKAR | VIDALI BAĞLANTI | 220V AC | 1 ad. | 113,625\$ |
| 129 087 000175 | İL-XLD-VT12-24K | LEDLİ DÖNER | VIDALI BAĞLANTI | 24V DC | 1 ad. | 100,999\$ |
| 129 087 000176 | İL-XLD-VT12-220K | LEDLİ DÖNER | VIDALI BAĞLANTI | 220V AC | 1 ad. | 113,625\$ |
| 129 087 000178 | İL-XLSB-VT12-24K | SABİT İŞİK+BUZZER | VIDALI BAĞLANTI | 24V DC | 1 ad. | 100,999\$ |
| 129 087 000179 | İL-XLSB-VT12-220K | SABİT İŞİK+BUZZER | VIDALI BAĞLANTI | 220V AC | 1 ad. | 113,625\$ |
| 129 087 000181 | İL-XLFB-VT12-24K | FLAŞÖRLÜ+BUZZER | VIDALI BAĞLANTI | 24V DC | 1 ad. | 116,781\$ |
| 129 087 000182 | İL-XLFB-VT12-220K | FLAŞÖRLÜ+BUZZER | VIDALI BAĞLANTI | 220V AC | 1 ad. | 126,250\$ |
| 129 087 000184 | İL-XÇB-VT12-24K | ÇAKAR+BUZZER | VIDALI BAĞLANTI | 24V DC | 1 ad. | 152,762\$ |
| 129 087 000185 | İL-XÇB-VT12-220K | ÇAKAR+BUZZER | VIDALI BAĞLANTI | 220V AC | 1 ad. | 166,649\$ |
| 129 087 000187 | İL-XLDB-VT12-24K | LEDLİ DÖNER+BUZZER | VIDALI BAĞLANTI | 24V DC | 1 ad. | 123,724\$ |
| 129 087 000188 | İL-XLDB-VT12-220K | LEDLİ DÖNER+BUZZER | VIDALI BAĞLANTI | 220V AC | 1 ad. | 138,874\$ |

RENK SEÇENEKLERİ: İL-XLS-T8-12K ● İL-XLS-T8-12S ● İL-XLS-T8-12Y ● İL-XLS-T8-12Y ● İL-XLS-T8-12M ● İL-XLS-T8-12B ○

İşli kolonlarda kırmızı sabit renktir. Diğer renkler siparişle yapılabilmektedir.



İL-X...V8 SERİSİ



İL-X...T8 SERİSİ



İL-X...VT8 SERİSİ



İL-X...VT10 SERİSİ



İL-X...VT12 SERİSİ



IL-X...-B ve Q Serisi Standart 85dB Ekonomik Seri İkaz Lambaları

Genel Özellikler

- Lens PC
- Gövde ABS
- 0...120db Ayarlanabilir Buzzer Sesi
- Led Işık
- 5 Ayrı Renk Seçeneği; Kırmızı, Sarı, Yeşil, Mavi, Beyaz
- 24V DC ve 24V, 220V AC Besleme
- Seçilebilir Farklı Çalışma Modelleri; Sabit, Flaşör, Çakar ve Döner



Isı



Yüksek Koruma Sınıfı



Şoka ve Vibrasyona Duyarlı



LED Işık



0...120db Ayarlanabilir Buzzer Sesi



| ÜRÜN KODU | ÇALIŞMA ŞEKLİ | BESLEME GERİLİMİ | Q-MODEL | B-MODEL | FİYAT |
|-----------|---------------|------------------|---------|---------|-------|
|-----------|---------------|------------------|---------|---------|-------|

IL-X...-BM Serisi Multi Fonksiyon Ayarlanabilir Sesli İkaz Lambaları

| | | | | |
|----------------|-----------|---------|-----------------|-----------|
| 129 087 000401 | Tek Katlı | 24V DC | IL-XLMB-BH-24X | 42,353 \$ |
| 129 087 000403 | Tek Katlı | 220V AC | IL-XLMB-BH-220X | 47,647 \$ |
| 129 087 000405 | İki Katlı | 24V DC | IL-XLMB-BH-242 | 52,941 \$ |
| 129 087 000407 | İki Katlı | 220V AC | IL-XLMB-BH-2202 | 58,235 \$ |
| 129 087 000409 | Üç Katlı | 24V DC | IL-XMB-BH-243 | 63,529 \$ |
| 129 087 000411 | Üç Katlı | 220V AC | IL-XMB-BH-2203 | 68,824 \$ |

IL-X...-QM Serisi Multi Fonksiyon Ayarlanabilir Sesli İkaz Lambaları

| | | | | |
|----------------|-----------|---------|-----------------|-----------|
| 129 087 000400 | Tek Katlı | 24V DC | IL-XLMB-QH-24X | 42,353 \$ |
| 129 087 000402 | Tek Katlı | 220V AC | IL-XLMB-QH-220X | 47,647 \$ |
| 129 087 000404 | İki Katlı | 24V DC | IL-XLMB-QH-242 | 52,941 \$ |
| 129 087 000406 | İki Katlı | 220V AC | IL-XLMB-QH-2202 | 58,235 \$ |
| 129 087 000408 | Üç Katlı | 24V DC | IL-XMB-QH-243 | 63,529 \$ |
| 129 087 000410 | Üç Katlı | 220V AC | IL-XMB-QH-2203 | 68,824 \$ |

RENK SEÇENEKLERİ: IL-XLMB-Q-12K ● IL-XLMB-Q-12S ● IL-XLMB-Q-12Y ● IL-XLMB-Q-12M ● IL-XLMB-Q-12B ○

- 4 Ayrı seçilebilir çalışma şekli
- 8 Farklı seçilebilir ses melodisi
- Potansiyometre ile 0..127 Db kadar ayarlanabilir ses seviyesi

| Ürün Kodu | Besleme Gerilimi | Ses dB | Çalışma Şekli | Fiyat |
|-----------|------------------|--------|---------------|-------|
|-----------|------------------|--------|---------------|-------|

IL-XB-B SERİSİ Ø 67 BORULU KORNALAR

| | | | | | |
|----------------|-------------|------|------------|-------------|-----------|
| 129 087 000230 | IL-XB-B-24 | 24V | 95dB/30 cm | KESİK KESİK | 42,353 \$ |
| 129 087 000233 | IL-XB-B-220 | 220V | 95dB/30 cm | KESİK KESİK | 42,353 \$ |

IL-XB-Q SERİSİ Ø 67 KÜBİK KORNALAR

| | | | | | |
|----------------|-------------|------|------------|-------------|-----------|
| 129 087 000235 | IL-XB-Q-24 | 24V | 95dB/30 cm | KESİK KESİK | 42,353 \$ |
| 129 087 000238 | IL-XB-Q-220 | 220V | 95dB/30 cm | KESİK KESİK | 42,353 \$ |

IL-XFM SERİSİ BUZZER

| | | | | | | |
|----------------|---------------------|------|-------------|----------|---------|-----------|
| 129 087 000245 | IL-XFM-12A-905AL70 | 12V | 90dB/30 cm | ÇİFT SES | KABLÖLÜ | 16,031 \$ |
| 129 087 000246 | IL-XFM-12Q-905L70 | 12V | 95dB/60 cm | ÇİFT SES | KABLÖLÜ | 16,031 \$ |
| 129 087 000247 | IL-XFM-24C-905L70 | 24V | 92dB/100 cm | ÇİFT SES | KABLÖLÜ | 16,031 \$ |
| 129 087 000248 | IL-XFM-220A-905AL70 | 220V | 95dB/30 cm | ÇİFT SES | KABLÖLÜ | 18,900 \$ |
| 129 087 000249 | IL-XFM-24C-900L700 | 24V | 92dB/100 cm | SÜREKLİ | KABLÖLÜ | 16,031 \$ |
| 129 087 000250 | IL-XFM-220A-905A | 12V | 90dB/300 cm | ÇİFT SES | SOKETLİ | 18,900 \$ |
| 129 087 000251 | IL-XFM-12A-905A | 220V | 90dB/30 cm | ÇİFT SES | SOKETLİ | 16,031 \$ |
| 129 087 000252 | IL-XFM-12Q-905 | 12V | 90dB/30 cm | ÇİFT SES | SOKETLİ | 16,031 \$ |

İşli kolonlarda kırmızı sabit renktir. Diğer renkler siparişle yapılabilmektedir.





TERMOPLASTİK BUATLAR VE KOMBİNASYON KUTULARI

| | | |
|---|---|---|
|  <p>ÜRÜN KODU 001 046 000101 00 00 ÜRÜN ADI 85X85 KARE ANTİGRON BUAT AMBALAJ ADET / KOLİ 10/300 FİYAT 2,222 TL</p> |  <p>ÜRÜN KODU 001 046 071414 00 00 ÜRÜN ADI 140X140X70 TERMOPLASTİK BUAT AMBALAJ ADET / KOLİ 10/80 FİYAT 10,027 TL</p> |  <p>ÜRÜN KODU 001 046 071130 00 17 ÜRÜN ADI 225X311X130 TERMOPLASTİK BUAT AMBALAJ ADET / KOLİ 1/4 FİYAT 34,332 TL</p> |
|  <p>ÜRÜN KODU 001 046 078080 00 17 ÜRÜN ADI 80X80X48 (7ÇIKIŞLI) TERMOPLASTİK BUAT AMBALAJ ADET / KOLİ 18/216 FİYAT 2,148 TL</p> |  <p>ÜRÜN KODU 001 046 071827 00 17 ÜRÜN ADI 180X270X100 (14ÇIKIŞ) TERMOPLASTİK BUAT AMBALAJ ADET / KOLİ 2/20 FİYAT 16,093 TL</p> |  <p>ÜRÜN KODU 001 046 072698 00 17 ÜRÜN ADI 138X226X98 TERMOPLASTİK BUAT AMBALAJ ADET / KOLİ 1/8 FİYAT 16,440 TL</p> |
|  <p>ÜRÜN KODU 001 046 078585 00 17 ÜRÜN ADI 85X85X48 TERMOPLASTİK BUAT AMBALAJ ADET / KOLİ 18/216 FİYAT 2,338 TL</p> |  <p>ÜRÜN KODU 001 046 073020 00 00 ÜRÜN ADI 300X200X125 TERMOPLASTİK BUAT AMBALAJ ADET / KOLİ 1/15 FİYAT 29,260 TL</p> |  <p>ÜRÜN KODU 001 046 076131 00 17 ÜRÜN ADI 138X226X131 TERMOPLASTİK BUAT AMBALAJ ADET / KOLİ 1/8 FİYAT 18,037 TL</p> |
|  <p>ÜRÜN KODU 001 046 070090 00 17 ÜRÜN ADI Ø90 TERMOPLASTİK BUAT AMBALAJ ADET / KOLİ 18/216 FİYAT 1,827 TL</p> |  <p>ÜRÜN KODU 001 046 073525 00 00 ÜRÜN ADI 350X255X125 TERMOPLASTİK BUAT AMBALAJ ADET / KOLİ 1/10 FİYAT 33,217 TL</p> |  <p>ÜRÜN KODU 001 046 072698 00 44 ÜRÜN ADI 138X226X98 (ŞEFFAF) TERMOPLASTİK BUAT AMBALAJ ADET / KOLİ 1/8 FİYAT 18,025 TL</p> |
|  <p>ÜRÜN KODU 001 046 071010 00 17 ÜRÜN ADI 110X110X74 (8 ÇIKIŞLI) TERMOPLASTİK BUAT AMBALAJ ADET / KOLİ 10/100 FİYAT 4,944 TL</p> |  <p>ÜRÜN KODU 001 046 078226 00 17 ÜRÜN ADI 138X226X127 KOMBİNASYON KUTUSU AMBALAJ ADET / KOLİ 1/8 FİYAT 21,848 TL</p> |  <p>ÜRÜN KODU 001 046 076131 00 44 ÜRÜN ADI 138X226X131 (ŞEFFAF) TERMOPLASTİK BUAT AMBALAJ ADET / KOLİ 1/8 FİYAT 19,902 TL</p> |
|  <p>ÜRÜN KODU 001 046 071118 00 17 ÜRÜN ADI 110X180X77 (10ÇIKIŞ) TERMOPLASTİK BUAT AMBALAJ ADET / KOLİ 5/60 FİYAT 7,838 TL</p> |  <p>ÜRÜN KODU 001 046 075311 00 17 ÜRÜN ADI 225X311X132 KOMBİNASYON KUTUSU AMBALAJ ADET / KOLİ 1/4 FİYAT 37,061 TL</p> |  <p>ÜRÜN KODU 001 046 071199 00 44 ÜRÜN ADI 225X311X99 (ŞEFFAF) TERMOPLASTİK BUAT AMBALAJ ADET / KOLİ 1/4 FİYAT 33,168 TL</p> |
|  <p>ÜRÜN KODU 001 046 071210 00 00 ÜRÜN ADI 125X100X75 TERMOPLASTİK BUAT AMBALAJ ADET / KOLİ 10/80 FİYAT 10,027 TL</p> |  <p>ÜRÜN KODU 001 046 071199 00 17 ÜRÜN ADI 225X311X99 TERMOPLASTİK BUAT AMBALAJ ADET / KOLİ 1/4 FİYAT 31,155 TL</p> |  <p>ÜRÜN KODU 001 046 071130 00 44 ÜRÜN ADI 225X311X130 (ŞEFFAF) TERMOPLASTİK BUAT AMBALAJ ADET / KOLİ 1/4 FİYAT 36,900 TL</p> |

ALEV YAYMAYAN TERMOPLASTİK BUATLAR VE KOMBİNASYON KUTULARI 

| | | |
|---|--|---|
|  <p>ÜRÜN KODU 001 046 098080 00 17 ÜRÜN ADI 80X80X48 (7ÇIKIŞLI) TERMOPLASTİK BUAT (GRİ) (A. YAYMAYAN) AMBALAJ ADET / KOLİ 18/216 FİYAT 3,501 TL</p> |  <p>ÜRÜN KODU 001 046 098226 00 17 ÜRÜN ADI 138X226X127 KOMBİNASYON KUTUSU (A. YAYMAYAN) AMBALAJ ADET / KOLİ 1/8 FİYAT 30,117 TL</p> |  <p>ÜRÜN KODU 001 046 092698 00 44 ÜRÜN ADI 138X226X98 (ŞEFFAF) TERMOPLASTİK BUAT (A. YAYMAYAN) AMBALAJ ADET / KOLİ 1/8 FİYAT 22,681 TL</p> |
|  <p>ÜRÜN KODU 001 046 098585 00 17 ÜRÜN ADI 85X85X48 TERMOPLASTİK BUAT (GRİ) (A. YAYMAYAN) AMBALAJ ADET / KOLİ 18/216 FİYAT 1,698 TL</p> |  <p>ÜRÜN KODU 001 046 095311 00 17 ÜRÜN ADI 225X311X132 KOMBİNASYON KUTUSU (A. YAYMAYAN) AMBALAJ ADET / KOLİ 1/4 FİYAT 45,811 TL</p> |  <p>ÜRÜN KODU 001 046 096131 00 44 ÜRÜN ADI 138X226X131(ŞEFFAF) TERMOPLASTİK BUAT (A. YAYMAYAN) AMBALAJ ADET / KOLİ 1/8 FİYAT 23,880 TL</p> |
|  <p>ÜRÜN KODU 001 046 090090 00 17 ÜRÜN ADI Ø90 TERMOPLASTİK BUAT (GRİ) (A. YAYMAYAN) AMBALAJ ADET / KOLİ 18/216 FİYAT 2,031 TL</p> |  <p>ÜRÜN KODU 001 046 091199 00 17 ÜRÜN ADI 225X311X99 TERMOPLASTİK BUAT (A. YAYMAYAN) AMBALAJ ADET / KOLİ 1/4 FİYAT 39,305 TL</p> |  <p>ÜRÜN KODU 001 046 091199 00 44 ÜRÜN ADI 225X311X99 (ŞEFFAF) TERMOPLASTİK BUAT (A. YAYMAYAN) AMBALAJ ADET / KOLİ 1/4 FİYAT 39,800 TL</p> |
|  <p>ÜRÜN KODU 001 046 091010 00 17 ÜRÜN ADI 110X110X74 (8ÇIKIŞLI) TERMOPLASTİK BUAT (A.YAYMAYAN) AMBALAJ ADET / KOLİ 10/100 FİYAT 10,572 TL</p> |  <p>ÜRÜN KODU 001 046 091130 00 17 ÜRÜN ADI 225X311X130 TERMOPLASTİK BUAT (A. YAYMAYAN) AMBALAJ ADET / KOLİ 1/4 FİYAT 49,349 TL</p> |  <p>ÜRÜN KODU 001 046 091130 00 44 ÜRÜN ADI 225X311X130 (ŞEFFAF) TERMOPLASTİK BUAT (A. YAYMAYAN) AMBALAJ ADET / KOLİ 1/4 FİYAT 38,727 TL</p> |
|  <p>ÜRÜN KODU 001 046 091118 00 17 ÜRÜN ADI 110X180X77 (10 ÇIK.) TERMOPLASTİK BUAT (GRİ) (A.YAYMAYAN) AMBALAJ ADET / KOLİ 5/60 FİYAT 16,564 TL</p> |  <p>ÜRÜN KODU 001 046 092698 00 17 ÜRÜN ADI 138X226X98 TERMOPLASTİK BUAT (A. YAYMAYAN) AMBALAJ ADET / KOLİ 1/8 FİYAT 21,159 TL</p> | |
|  <p>ÜRÜN KODU 001 046 091827 00 17 ÜRÜN ADI 180X270X100 (14ÇIK.) TERMOPLASTİK BUAT (A.YAYMAYAN)(GRİ) AMBALAJ ADET / KOLİ 2/20 FİYAT 42,199 TL</p> |  <p>ÜRÜN KODU 001 046 096131 00 17 ÜRÜN ADI 138X226X131 TERMOPLASTİK BUAT (A. YAYMAYAN) AMBALAJ ADET / KOLİ 1/8 FİYAT 26,402 TL</p> | |

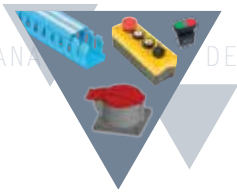

| Kod | Açıklama / Stok Cinsi | Amb. (Kutu/Bağ) | Amb. (Koli/Çvt.) | FİYAT |
|--|--|--------------------|---------------------|-----------|
| PANO FİLTRESİ | | | | |
| 054 126 020002 | 150X150 PANO FİLTRESİ | 1 ad. | | 6,726 |
| PLASTİK OPAK KAPAKLI PANOLARI | | | | |
| 048 090 203013 | 20X30X13 PLASTİK OPAK KAPAKLI PANO | 1 ad. | | 49,152 |
| 048 090 253515 | 25X35X15 PLASTİK OPAK KAPAKLI PANO | 1 ad. | | 52,562 |
| 048 090 304017 | 30X40X17 PLASTİK OPAK KAPAKLI PANO | 1 ad. | | 74,439 |
| 048 090 304022 | 30X40X22 PLASTİK OPAK KAPAKLI PANO | 1 ad. | | 88,076 |
| 048 090 355019 | 35X50X19 PLASTİK OPAK KAPAKLI PANO | 1 ad. | | 106,544 |
| 048 090 405018 | 40X50X17,5 PLASTİK OPAK KAPAKLI PANO | 1 ad. | | 110,806 |
| 048 090 405024 | 40X50X24 PLASTİK OPAK KAPAKLI PANO | 1 ad. | | 125,864 |
| 048 090 406020 | 40X60X20 PLASTİK OPAK KAPAKLI PANO | 1 ad. | | 130,694 |
| 048 090 507025 | 50X70X25 PLASTİK OPAK KAPAKLI PANO | 1 ad. | | 257,411 |
| 048 090 608026 | 60X80X26 PLASTİK OPAK KAPAKLI PANO | 1 ad. | | 441,235 |
| PLASTİK ŞEFFAF KAPAKLI PANOLARI | | | | |
| 048 088 203013 | 20X30X13 PLASTİK ŞEFFAF KAPAKLI PANO | 1 ad. | | 61,938 |
| 048 088 253515 | 25X35X15 PLASTİK ŞEFFAF KAPAKLI PANO | 1 ad. | | 68,756 |
| 048 088 304017 | 30X40X17 PLASTİK ŞEFFAF KAPAKLI PANO | 1 ad. | | 86,940 |
| 048 088 304022 | 30X40X22 PLASTİK ŞEFFAF KAPAKLI PANO | 1 ad. | | 96,032 |
| 048 088 355019 | 35X50X19 PLASTİK ŞEFFAF KAPAKLI PANO | 1 ad. | | 121,318 |
| 048 088 405018 | 40X50X17,5 PLASTİK ŞEFFAF KAPAKLI PANO | 1 ad. | | 153,424 |
| 048 088 405024 | 40X50X24 PLASTİK ŞEFFAF KAPAKLI PANO | 1 ad. | | 157,969 |
| 048 088 406020 | 40X60X20 PLASTİK ŞEFFAF KAPAKLI PANO | 1 ad. | | 160,242 |
| 048 088 507025 | 50X70X25 PLASTİK ŞEFFAF KAPAKLI PANO | 1 ad. | | 345,487 |
| 048 088 608026 | 60X80X26 PLASTİK ŞEFFAF KAPAKLI PANO | 1 ad. | | 555,450 |
| OTOMATİK DAĞITIM PANOLARI | | | | |
| 048 086 253515 | 25X35X15 OTOMATİK DAĞITIM PANOSU (2X9) OPAK | 1 ad. | | 88,076 |
| 048 086 304017 | 30X40X17 OTOMATİK DAĞITIM PANOSU (2X12) OPAK | 1 ad. | | 112,226 |
| 048 086 355019 | 35X50X19 OTOMATİK DAĞITIM PANOSU (15X3) OPAK | 1 ad. | | 163,652 |
| 048 086 406020 | 40X60X20 OTOMATİK DAĞITIM PANOSU (15X4) OPAK | 1 ad. | | 198,030 |
| 048 087 253515 | 25X35X15 OTOMATİK DAĞITIM PANOSU (2X9) ŞEFFAF | 1 ad. | | 105,124 |
| 048 087 304017 | 30X40X17 OTOMATİK DAĞITIM PANOSU (2X12) ŞEFFAF | 1 ad. | | 123,591 |
| 048 087 355019 | 35X50X19 OTOMATİK DAĞITIM PANOSU (15X3) ŞEFFAF | 1 ad. | | 190,927 |
| 048 087 406020 | 40X60X20 OTOMATİK DAĞITIM PANOSU (15X4) ŞEFFAF | 1 ad. | | 223,032 |
| POLYESTER ETANJ PANOLAR (POSEL) | | | | |
| 009 089 001510 | S/A TEKLI SAYAÇ PANOSU MONOFAZE | 1 ad. | 20 | 45,175 |
| 009 089 152011 | 15X20X11 POLYESTER ETANJ PANO | 1 ad. | 12 | 40,629 |
| 009 089 162610 | 16X26X10 POLYESTER ETANJ PANO | 1 ad. | 20 | 39,066 |
| 009 089 202517 | 20X25X17 POLYESTER ETANJ PANO | 1 ad. | 10 | 59,381 |
| 009 089 202512 | 20X25X12 POLYESTER ETANJ PANO | 1 ad. | 12 | 59,381 |
| 009 089 203017 | 30X20X17 POLYESTER ETANJ PANO | 1 ad. | 8 | 60,943 |
| 009 089 203012 | 30X20X12 POLYESTER ETANJ PANO | 1 ad. | 12 | 60,943 |
| 009 089 253017 | 25X30X17 POLYESTER ETANJ PANO | 1 ad. | 6 | 81,258 |
| 009 089 253012 | 25X30X12 POLYESTER ETANJ PANO | 1 ad. | 6 | 81,258 |
| 009 089 304017 | 30X40X17 POLYESTER ETANJ PANO | 1 ad. | 4 | 87,508 |
| 009 089 304012 | 30X40X12 POLYESTER ETANJ PANO | 1 ad. | 5 | 87,508 |
| 009 089 355022 | 35X50X22 POLYESTER ETANJ PANO | 1 ad. | 3 | 128,137 |
| 009 089 355017 | 35X50X17 POLYESTER ETANJ PANO | 1 ad. | 3 | 128,137 |
| 009 089 406022 | 40X60X22 POLYESTER ETANJ PANO | 1 ad. | 3 | 131,262 |
| 009 089 406017 | 40X60X17 POLYESTER ETANJ PANO | 1 ad. | 3 | 131,262 |
| 009 089 406027 | 40X60X27 POLYESTER ETANJ PANO | 1 ad. | 2 | 156,265 |
| 009 089 508022 | 50X80X22 POLYESTER ETANJ PANO | 1 ad. | 1 | 328,156 |
| 009 089 508027 | 50X80X27 POLYESTER ETANJ PANO | 1 ad. | 1 | 328,156 |
| 009 089 508032 | 50X80X32 POLYESTER ETANJ PANO | 1 ad. | 1 | 328,156 |
| 009 089 701001 | 70X100X33 POLYESTER ETANJ PANO (TEK KAPI) | 1 ad. | 1 | 1.218,865 |
| 009 089 701002 | 70X100X33 POLYESTER ETANJ PANO (ÇİFT KAPI) | 1 ad. | 1 | 1.218,865 |
| PLASTİK OPAK PANOLAR | | | | |
| 048 089 212813 | 21X28X13 PLASTİK OPAK PANO | 1 ad. | | 63,926 |
| 048 089 253313 | 25X33X13 PLASTİK OPAK PANO | 1 ad. | | 69,041 |
| 048 089 304017 | 30X40X16,5 PLASTİK OPAK PANO | 1 ad. | | 96,543 |
| 048 089 405018 | 40X50X17,5 PLASTİK OPAK PANO | 1 ad. | | 143,764 |
| 048 089 406020 | 40X60X20 PLASTİK OPAK PANO | 1 ad. | | 180,784 |
| 048 089 507025 | 50X70X24,5 PLASTİK OPAK PANO | 1 ad. | | 332,759 |
| 048 089 355020 | 35X50X19,5 PLASTİK OPAK PANO | 1 ad. | | 143,764 |
| LOGAR KUTUSU | | | | |
| 074 048 622020 | 20X20 LOGAR KUTUSU TAKIM | 1 ad. | | 20,406 |
| 074 048 623030 | 30X30 LOGAR KUTUSU TAKIM | 1 ad. | | 40,869 |
| 074 048 624040 | 40X40 LOGAR KUTUSU TAKIM | 1 ad. | | 70,658 |
| 074 048 625050 | 50X50 LOGAR KUTUSU TAKIM | 1 ad. | | 160,587 |
| 074 048 625555 | 55X55 LOGAR KUTUSU TAKIM | 1 ad. | | 240,880 |



CANALEX
EKO SERİSİ
MEKS SERİSİ

SANAYİ TİPİ ÜRÜNLER

YENİ



LED PANNELER
MEKS PLUS
H-FREE SPİLLARER
COMFORT SERİSİ

MUTLUSAN SANAYİ FİŞ-PRİZ GRUBU (MONOFAZE 1X16 A.)

| | | |
|---|---|--|
|  <p>ÜRÜN KODU 010 083 500298 ÜRÜN ADI MUT-298 MONOFAZE TOPRAKLI PANO PRİZİ AMBALAJ ADET / KOLİ 40/320 FİYAT 4,581 TL</p> |  <p>ÜRÜN KODU 010 083 501297 ÜRÜN ADI MUT-298-U MONOFAZE UPS TOP. PANO PRİZİ AMBALAJ ADET / KOLİ 30/240 FİYAT 7,314 TL</p> |  <p>ÜRÜN KODU 010 083 500297 ÜRÜN ADI MUT-297 MONO.DUVAR PRİZİ (PLASTİK) AMBALAJ ADET / KOLİ 30/240 FİYAT 10,521 TL</p> |
|  <p>ÜRÜN KODU 010 083 500299 ÜRÜN ADI MUT-299 MONO. MAKİNA PRİZİ AMBALAJ ADET / KOLİ 20/160 FİYAT 9,017 TL</p> |  <p>ÜRÜN KODU 010 083 502910 ÜRÜN ADI MUT-2910 MONO. DUVAR PRİZİ AMBALAJ ADET / KOLİ 15/120 FİYAT 9,971 TL</p> | |

MUTLUSAN SANAYİ FİŞ-PRİZ GRUBU (TRİFAZE 3X16 A.)

| | |
|--|--|
|  <p>ÜRÜN KODU 010 083 400064 ÜRÜN ADI MUT-64 3X16 TRİFAZE MAKİNA PRİZİ (PLS.) AMBALAJ ADET / KOLİ 20/160 FİYAT 10,315 TL</p> |  <p>ÜRÜN KODU 010 083 400063 ÜRÜN ADI MUT-63 3X16 TRİFAZE DUVAR PRİZİ (PLS.) AMBALAJ ADET / KOLİ 12/96 FİYAT 14,212 TL</p> |
|--|--|

MUTLUSAN SANAYİ FİŞ-PRİZ GRUBU (TRİFAZE 3X25 A.)

| | |
|---|--|
|  <p>ÜRÜN KODU 010 083 400318 ÜRÜN ADI MUT-318 3X25 TRİFAZE MAKİNA PRİZİ (PLASTİK) AMBALAJ ADET / KOLİ 20/160 FİYAT 10,407 TL</p> |  <p>ÜRÜN KODU 010 083 400319 ÜRÜN ADI MUT-319 3X25 TRİFAZE DUVAR PRİZİ (PLASTİK) AMBALAJ ADET / KOLİ 15/120 FİYAT 12,717 TL</p> |
|---|--|

MUTLUSAN SANAYİ FİŞ-PRİZ GRUBU (TRİFAZE 3X25 A.)

| | |
|---|---|
|  <p>ÜRÜN KODU 010 083 400074 ÜRÜN ADI MUT-74 3X32 TRİFAZE MAKİNA PRİZİ (PLS.) AMBALAJ ADET / KOLİ 20/160 FİYAT 11,310 TL</p> |  <p>ÜRÜN KODU 010 083 400073 ÜRÜN ADI MUT-73 3X32 TRİFAZE DUVAR PRİZİ (PLS.) AMBALAJ ADET / KOLİ 12/96 FİYAT 15,180 TL</p> |
|---|---|

TRİFAZE FİŞ-PRİZLER

| | |
|--|---|
|  <p>ÜRÜN KODU 041 116 000002 ÜRÜN ADI TRİFAZE PRİZ AMBALAJ ADET / KOLİ 20 FİYAT 10,463 TL</p> |  <p>ÜRÜN KODU 041 116 000001 ÜRÜN ADI TRİFAZE FİŞ AMBALAJ ADET / KOLİ 12 FİYAT 10,249 TL</p> |
|--|---|

CEE NORM SANAYİ TİPİ FİŞ ve PRİZLER

YENİ



ÜRÜN KODU
010 083 000516
ÜRÜN ADI
CEE NORM 5X16 A
DÜZ FİŞ
AMBALAJ ADET / KOLİ
16/128
FİYAT
15,924 TL



ÜRÜN KODU
010 083 000532
ÜRÜN ADI
CEE NORM 5X32 A
DÜZ FİŞ
AMBALAJ ADET / KOLİ
15/120
FİYAT
20,240 TL



ÜRÜN KODU
010 083 010516
ÜRÜN ADI
CEE NORM 5X16 A
UZATMA PRİZİ
AMBALAJ ADET / KOLİ
15/120
FİYAT
19,347 TL



ÜRÜN KODU
010 083 010532
ÜRÜN ADI
CEE NORM 5X32 A
UZATMA PRİZİ
AMBALAJ ADET / KOLİ
14/112
FİYAT
23,812 TL



ÜRÜN KODU
010 083 020516
ÜRÜN ADI
CEE NORM 5X16 A
MAKİNE PRİZİ
AMBALAJ ADET / KOLİ
20/160
FİYAT
17,859 TL



ÜRÜN KODU
010 083 020532
ÜRÜN ADI
CEE NORM 5X32 A
MAKİNE PRİZİ
AMBALAJ ADET / KOLİ
20/160
FİYAT
22,324 TL



ÜRÜN KODU
010 083 030516
ÜRÜN ADI
CEE NORM 5X16 A
DUVAR PRİZİ
AMBALAJ ADET / KOLİ
8/64
FİYAT
25,300 TL



ÜRÜN KODU
010 083 030532
ÜRÜN ADI
CEE NORM 5X32 A
DUVAR PRİZİ
AMBALAJ ADET / KOLİ
8/64
FİYAT
28,276 TL

MUTLUSAN SANAYİ FİŞ-PRİZ GRUBU (TRİFAZE 3X16 A.)



ÜRÜN KODU
010 083 400060
ÜRÜN ADI
MUT-60 3X16 TRİFAZE
ERKEK FİŞ
AMBALAJ ADET / KOLİ
30/240
FİYAT
10,525 TL



ÜRÜN KODU
010 083 400061
ÜRÜN ADI
MUT-61 3X16 TRİFAZE
SEYYAR DİŞİ FİŞ
AMBALAJ ADET / KOLİ
25/200
FİYAT
15,709 TL



ÜRÜN KODU
010 083 400062
ÜRÜN ADI
MUT-62 3X16 TRİFAZE
DUVAR PRİZİ
AMBALAJ ADET / KOLİ
20/160
FİYAT
15,210 TL

MUTLUSAN SANAYİ FİŞ-PRİZ GRUBU (TRİFAZE 3X32 A.)



ÜRÜN KODU
010 083 400070
ÜRÜN ADI
MUT-70 3X32 TRİFAZE
ERKEK FİŞ
AMBALAJ ADET / KOLİ
20/160
FİYAT
16,181 TL



ÜRÜN KODU
010 083 400071
ÜRÜN ADI
MUT-71 3X32 TRİFAZE
SEYYAR DİŞİ FİŞ
AMBALAJ ADET / KOLİ
20/160
FİYAT
18,671 TL



ÜRÜN KODU
010 083 400072
ÜRÜN ADI
MUT-72 3X32 TRİFAZE
DUVAR PRİZİ
AMBALAJ ADET / KOLİ
20/160
FİYAT
22,621 TL

MUTLUSAN SANAYİ FİŞ-PRİZ GRUBU (MONOFAZE 1X16 A.)

| | | |
|---|---|---|
|  <p>ÜRÜN KODU 010 083 300027 ÜRÜN ADI MUT-27 1X16 A. MONO. TOP. ERKEK FİŞ(EĞİK) AMBALAJ ADET / KOLİ 50/400 FİYAT 4,465 TL</p> |  <p>ÜRÜN KODU 010 083 300028 ÜRÜN ADI MUT-28 1X16 A. MONO. TOP. ERKEK FİŞ(DÜZ) AMBALAJ ADET / KOLİ 50/400 FİYAT 4,465 TL</p> |  <p>ÜRÜN KODU 010 083 300029 ÜRÜN ADI MUT-29 1X16 A. MONO. TOPRAKLI DİŞİ FİŞ AMBALAJ ADET / KOLİ 30/240 FİYAT 6,251 TL</p> |
|  <p>ÜRÜN KODU 010 083 500296 ÜRÜN ADI MUT-296 1X16 A. MONO. TOP. DUVAR PRİZ AMBALAJ ADET / KOLİ 20/160 FİYAT 9,822 TL</p> |  <p>ÜRÜN KODU 010 083 500293 ÜRÜN ADI MUT-293 1X16 A. MONO. 3'LÜ GRUP PRİZ AMBALAJ ADET / KOLİ 12/96 FİYAT 15,304 TL</p> |  <p>ÜRÜN KODU 010 083 500294 ÜRÜN ADI MUT-294 1X16 A. MONO. 4'LÜ GRUP PRİZ AMBALAJ ADET / KOLİ 12/96 FİYAT 18,603 TL</p> |
|  <p>ÜRÜN KODU 010 083 501292 ÜRÜN ADI MUT-292A 1X16 A. MONO. 2'Lİ GR. PRİZ ANH. AMBALAJ ADET / KOLİ 12/96 FİYAT 19,347 TL</p> |  <p>ÜRÜN KODU 010 083 501293 ÜRÜN ADI MUT-293A 1X16 A. MONO. 3'LÜ GR. PRİZ ANH. AMBALAJ ADET / KOLİ 10/80 FİYAT 22,323 TL</p> |  <p>ÜRÜN KODU 010 083 500292 ÜRÜN ADI MUT-292 1X16 A. MONO. 2'Lİ GRUP PRİZ AMBALAJ ADET / KOLİ 12/96 FİYAT 12,352 TL</p> |

MUTLUSAN SANAYİ FİŞ-PRİZ GRUBU (TRİFAZE 3X25 A.)

| | | |
|--|--|--|
|  <p>ÜRÜN KODU 010 083 400030 ÜRÜN ADI MUT-30 3X25 TRİFAZE ERKEK FİŞ AMBALAJ ADET / KOLİ 30/240 FİYAT 6,251 TL</p> |  <p>ÜRÜN KODU 010 083 400031 ÜRÜN ADI MUT-31 3X25 TRİFAZE DİŞİ FİŞ (SEYYAR) AMBALAJ ADET / KOLİ 20/160 FİYAT 9,822 TL</p> |  <p>ÜRÜN KODU 010 083 600315 ÜRÜN ADI MUT-315 3X25 TRİFAZE DUVAR PRİZİ AMBALAJ ADET / KOLİ 20/160 FİYAT 12,739 TL</p> |
|  <p>ÜRÜN KODU 010 083 600311 ÜRÜN ADI MUT-311 1 TRİFAZE 1 MONOFAZE GRUP PRİZ AMBALAJ ADET / KOLİ 10/80 FİYAT 23,610 TL</p> |  <p>ÜRÜN KODU 010 083 600312 ÜRÜN ADI MUT-312 TRİFAZE 2'Lİ GRUP PRİZ AMBALAJ ADET / KOLİ 10/80 FİYAT 25,300 TL</p> |  <p>ÜRÜN KODU 010 083 600313 ÜRÜN ADI MUT-313 TRİFAZE 3'LÜ GRUP PRİZ AMBALAJ ADET / KOLİ 10/80 FİYAT 35,717 TL</p> |
|  <p>ÜRÜN KODU 010 083 600316 ÜRÜN ADI MUT-316. 2 TRİFAZE+1 MONOFAZE GRUP PRİZ AMBALAJ ADET / KOLİ 10/80 FİYAT 32,741 TL</p> |  <p>ÜRÜN KODU 010 083 600317 ÜRÜN ADI MUT-317 1 TRİFAZE+2 MONOFAZE GRUP PRİZ AMBALAJ ADET / KOLİ 8/64 FİYAT 30,771 TL</p> | |

| Kod | Açıklama / Stok Cinsi | Amb. (Kutu/Bağ) | Amb. (Koli/Çvl.) | FİYAT |
|--|---|--------------------|---------------------|--------|
| SEYYAR EL LAMBALARI (TEL KAFESLİ) | | | | |
| 005 084 700003 | BALADOZ PLASTİK SAPLI (DUYSUZ-ANAHT.SIZ) | 1 ad. | 25 | 12,799 |
| 005 084 700009 | BALADOZ PLASTİK SAPLI (DUYLU-ANAHT.SIZ) | 1 ad. | 25 | 17,263 |
| 005 084 700004 | BALADOZ PLASTİK SAPLI (PORS.DUYLU-ANHT.) | 1 ad. | 25 | 19,645 |
| 005 084 700006 | BALADOZ PLASTİK SAPLI (PORS.DUYLU-ANHT.) 5 MT | 1 ad. | 15 | 30,360 |
| 005 084 700007 | BALADOZ PLASTİK SAPLI (PORS.DUYLU-ANHT.) 10 MT | 1 ad. | 12 | 37,206 |
| 005 084 700010 | BALADOZ PLASTİK SAPLI (PORS.DUYLU-ANHT.) 15 MT | 1 ad. | 10 | 47,623 |
| 005 084 700011 | BALADOZ PLASTİK SAPLI (PORS.DUYLU-ANHT.) 20 MT | 1 ad. | 8 | 57,148 |
| 005 084 700012 | BALADOZ PLASTİK SAPLI (PORS.DUYLU-ANHT.) 25 MT | 1 ad. | 8 | 66,375 |
| 005 084 700008 | BALADOZ PLASTİK SAPLI PORS.DUYLU-ANHT (PLS CAMLI) | 1 ad. | 25 | 41,670 |

| | | | | |
|---|-------------------------------------|-------|---|---------|
| KABLO MAKARALARI (PLASTİK GÖVDE) | | | | |
| 005 083 700045 | KOD-45 MONOFAZE PLASTİK BOŞ MAKARA | 1 ad. | 4 | 41,670 |
| 005 083 700046 | KOD-46 TRİFAZE PLASTİK BOŞ MAKARA | 1 ad. | 4 | 63,993 |
| 120 085 000025 | MONOFAZE 3X1,5 KABLOLU MAKARA 25 MT | 1 ad. | 4 | 163,704 |
| 120 085 000035 | MONOFAZE 3X1,5 KABLOLU MAKARA 35 MT | 1 ad. | 4 | 208,351 |
| 120 085 000050 | MONOFAZE 3X1,5 KABLOLU MAKARA 50 MT | 1 ad. | 4 | 282,762 |

| | | | | |
|--------------------------|--|-------|---|---------|
| ÇANTALI MAKARALAR | | | | |
| 049 122 020012 | 4 MONO.PRİZ ÇIKIŞLI (20 mt.3X1,5) ÇANTALI MAKARA | 1 ad. | 4 | 88,401 |
| 049 122 020013 | 4 MONO.PRİZ ÇIKIŞLI (35 mt.3X1,5) ÇANTALI MAKARA | 1 ad. | 4 | 128,918 |
| 049 122 020014 | 4 MONO.PRİZ ÇIKIŞLI (50 mt.3X1,5) ÇANTALI MAKARA | 1 ad. | 4 | 154,702 |
| 049 122 020015 | 4 MONO.PRİZ ÇIKIŞLI (20 mt.3X2,5) ÇANTALI MAKARA | 1 ad. | 4 | 117,868 |
| 049 122 020016 | 4 MONO.PRİZ ÇIKIŞLI (30 mt.3X2,5) ÇANTALI MAKARA | 1 ad. | 4 | 154,702 |
| 049 122 020017 | 4 MONO.PRİZ ÇIKIŞLI (40 mt.3X2,5) ÇANTALI MAKARA | 1 ad. | 4 | 191,536 |

| | | | | |
|---------------------------------------|-----------------------------|-------|----|---------|
| SİNTAŞ SANAYİ TİPİ FİŞ PRİZLER | | | | |
| 019 107 016250 | 16X25 A.4 KUTUPLU FİŞ-PRİZ | 1 ad. | 30 | 37,215 |
| 019 107 016252 | 16X25 A.4 KUTUPLU PRİZ | 1 ad. | 45 | 21,053 |
| 019 107 016251 | 16X25 A.4 KUTUPLU FİŞ | 1 ad. | 60 | 16,228 |
| 019 107 025400 | 25x40 A.4 KUTUPLU FİŞ-PRİZ | 1 ad. | 15 | 58,797 |
| 019 107 025402 | 25x40 A.4 KUTUPLU PRİZ | 1 ad. | 25 | 33,065 |
| 019 107 025401 | 25x40 A.4 KUTUPLU FİŞ | 1 ad. | 35 | 24,260 |
| 019 107 040630 | 40X63 A.4 KUTUPLU FİŞ-PRİZ | 1 ad. | 10 | 77,770 |
| 019 107 040632 | 40X63 A.4 KUTUPLU PRİZ | 1 ad. | 15 | 40,674 |
| 019 107 040631 | 40X63 A.4 KUTUPLU FİŞ | 1 ad. | 25 | 37,222 |
| 019 107 063100 | 63X100 A.4 KUTUPLU FİŞ-PRİZ | 1 ad. | 5 | 128,203 |
| 019 107 063102 | 63X100 A.4 KUTUPLU PRİZ | 1 ad. | 10 | 67,123 |
| 019 107 063101 | 63X100 A.4 KUTUPLU FİŞ | 1 ad. | 15 | 61,896 |

| | | | | |
|--|--------------------------------|-------|----|--------|
| SİNTAŞ SANAYİ TİPİ SEYYAR PRİZLER | | | | |
| 019 107 016253 | 16X25 A.4 KUTUPLU SEYYAR PRİZ | 1 ad. | 45 | 21,053 |
| 019 107 025403 | 25x40 A.4 KUTUPLU SEYYAR PRİZ | 1 ad. | 25 | 33,065 |
| 019 107 040633 | 40X63 A.4 KUTUPLU SEYYAR PRİZ | 1 ad. | 15 | 40,674 |
| 019 107 063103 | 63X100 A.4 KUTUPLU SEYYAR PRİZ | 1 ad. | 10 | 67,123 |

| | | | | |
|-----------------------------------|-------------------------------------|-------|--|--------|
| 8'Lİ ve 10'LU GRUP PRİZLER | | | | |
| 049 122 000002 | 8 LI KLEMENSLİ GRUP PRİZ | 9 ad. | | 38,694 |
| 049 122 000003 | 10 LU KLEMENSLİ GRUP PRİZ | 9 ad. | | 44,647 |
| 049 122 000005 | 8 LI KLEMENSLİ GRUP PRİZ ANAHTARLI | 9 ad. | | 43,158 |
| 049 122 000004 | 10 LU KLEMENSLİ GRUP PRİZ ANAHTARLI | 9 ad. | | 49,111 |
| 049 122 010001 | 8 LI 2MT GRUP PRİZ | 6 ad. | | 52,088 |
| 049 122 010004 | 8 LI 2MT GRUP PRİZ ANAHTARLI | 6 ad. | | 56,552 |
| 049 122 010002 | 10 LU 2MT GRUP PRİZ | 6 ad. | | 58,041 |
| 049 122 010003 | 10 LU 2MT GRUP PRİZ ANAHTARLI | 6 ad. | | 62,505 |



| | | | | | |
|-------------------------|--|--|--|-------|-----------|
| ASANSÖR PANOLARI | | | | Adet | Fiyat |
| 010 091 020003 | ASANSÖR REVİZYON KUTUSU (BOŞ) | | | 1 ad. | 133,941 |
| 010 091 020010 | 5X40 ASANSÖR BESLEME PANOSU(5X40 AMP.PAKO+4X40 AMP.K.A.K+4X40 SİG.+2X25 AMP.K.A.K+3AD.X1X16 AMP.SİG. ŞALT OTOM.AOG | | | 1 ad. | 565,529 |
| 010 091 020011 | 5X63 ASANSÖR BESLEME PANOSU(5X63 AMP.PAKO+4X63 AMP.K.A.K+4X63 SİG.+2X25 AMP.K.A.K+3AD.X1X16 AMP.SİG. ŞALT OTOM.AOG | | | 1 ad. | 595,294 |
| 010 091 020012 | 6X40 ASANSÖR BESLEME PANOSU(6X40 AMP.PAKO+4X40 AMP.K.A.K+4X40 SİG.+2X25 AMP.K.A.K+3AD.X1X16 AMP.SİG. ŞALT OTOM.AOG | | | 1 ad. | 595,294 |
| 010 091 020013 | 6X63 ASANSÖR BESLEME PANOSU(6X63 AMP.PAKO+4X63 AMP.K.A.K+4X63 SİG.+2X25 AMP.K.A.K+3AD.X1X16 AMP.SİG. ŞALT OTOM.AOG | | | 1 ad. | 625,059 |
| 010 091 020020 | 5X40 ASANSÖR BESLEME PANOSU(5X40 AMP.PAKO+4X40 AMP.K.A.K+4X40 SİG.+2X25 AMP.K.A.K+3AD.X1X16 AMP.SİG. ŞALT OTOM.SIEMENS | | | 1 ad. | 892,941 |
| 010 091 020021 | 5X63 ASANSÖR BESLEME PANOSU(5X63 AMP.PAKO+4X63 AMP.K.A.K+4X63 SİG.+2X25 AMP.K.A.K+3AD.X1X16 AMP.SİG. ŞALT OTOM.SIEMENS | | | 1 ad. | 982,235 |
| 010 091 020022 | 6X40 ASANSÖR BESLEME PANOSU(6X40 AMP.PAKO+4X40 AMP.K.A.K+4X40 SİG.+2X25 AMP.K.A.K+3AD.X1X16 AMP.SİG. ŞALT OTOM.SIEMENS | | | 1 ad. | 922,706 |
| 010 091 020023 | 6X63 ASANSÖR BESLEME PANOSU(6X63 AMP.PAKO+4X63 AMP.K.A.K+4X63 SİG.+2X25 AMP.K.A.K+3AD.X1X16 AMP.SİG. ŞALT OTOM.SIEMENS | | | 1 ad. | 1.012,000 |



| Kod | Açıklama / Stok Cinsi | Amb. (Kutu/Bağ) | Amb. (Koli/Çvt.) | FİYAT |
|--|---------------------------------------|--------------------|---------------------|-----------|
| 0,6-1 KV BAKIR İLETKENLER İÇİN REÇİNELİ EK MUFLAR | | | | |
| 052 125 010019 | E1 404-E1 406 (4X4-4X6) | 1 ad. | | 40,000 |
| 052 125 010020 | E1 410 (4X10) | 1 ad. | | 62,038 |
| 052 125 010022 | E1 416 (4X16) | 1 ad. | | 63,397 |
| 052 125 010033 | E1 31610 (3X16+10) | 1 ad. | | 62,793 |
| 052 125 010034 | E1 32516 (3X25+16) | 1 ad. | | 66,114 |
| 052 125 010035 | E1 33516 (3X35+16) | 1 ad. | | 69,434 |
| 052 125 010036 | E1 35025 (3X50+25) | 1 ad. | | 72,303 |
| 052 125 010037 | E1 37035 (3X70+35) | 1 ad. | | 115,699 |
| 052 125 010038 | E1 39550 (3X95+50) | 1 ad. | | 121,209 |
| 052 125 010039 | E1 31207 (3X120+70) | 1 ad. | | 192,907 |
| 052 125 010040 | E1 31507 (3X150+70) | 1 ad. | | 201,813 |
| 052 125 010041 | E1 31859 (3X185+95) | 1 ad. | | 297,512 |
| 052 125 010042 | E1 32401 (3X240+120) | 1 ad. | | 311,323 |
| PROTOLİN (REÇİNE) | | | | |
| 052 125 030200 | PRO 210 GR. PROTOLİN REÇİNE | 1 ad. | | 13,812 |
| 052 125 030500 | PRO 500 GR. PROTOLİN REÇİNE | 1 ad. | | 22,642 |
| 052 125 031000 | PRO 1000 GR. PROTOLİN REÇİNE | 1 ad. | | 40,604 |
| 052 125 031500 | PRO 1500 GR. PROTOLİN REÇİNE | 1 ad. | | 61,133 |
| 052 125 033000 | PRO 3 KG PROTOLİN REÇİNE | 1 ad. | | 122,265 |
| 052 125 030040 | PRO 4 KG PROTOLİN REÇİNE | 1 ad. | | 141,888 |
| 052 125 030020 | PRO 20 KG PROTOLİN REÇİNE | 1 ad. | | 694,344 |
| 0,6-1 KV A.G. PAPUÇSUZ REÇİNELİ KABLO BAŞLIKLARI | | | | |
| 052 125 070001 | PKB 01 (2X1,5-3X50+25) | 1 ad. | | 16,378 |
| 052 125 070002 | PKB 02 (3X70+35-3X95+50) | 1 ad. | | 23,472 |
| 052 125 070003 | PKB 03 (3X120+70-3X150+70) | 1 ad. | | 40,680 |
| 0,6-1 KV BAKIR İLETKENLER İÇİN ISI BÜZÜŞMELİ EK MUFLARI | | | | |
| 052 125 020011 | S1 404-S1 406 (4X4-4X6) ISI BÜZÜŞMELİ | 1 ad. | | 19,396 |
| 052 125 020001 | S1 410 (4X10) ISI BÜZÜŞMELİ | 1 ad. | | 24,378 |
| 052 125 020002 | S1 416 (4X16) ISI BÜZÜŞMELİ | 1 ad. | | 25,812 |
| 052 125 120425 | S1 425 (4X25) ISI BÜZÜŞMELİ | 1 ad. | | 39,849 |
| 052 125 120435 | S1 435 (4X35) ISI BÜZÜŞMELİ | 1 ad. | | 42,868 |
| 052 125 120450 | S1 450 (4X50) ISI BÜZÜŞMELİ | 1 ad. | | 46,340 |
| 052 125 120470 | S1 470 (4X70) ISI BÜZÜŞMELİ | 1 ad. | | 68,755 |
| 052 125 120495 | S1 495 (4X95) ISI BÜZÜŞMELİ | 1 ad. | | 75,472 |
| 052 125 020003 | S1 31610 (3X16+10) ISI BÜZÜŞMELİ | 1 ad. | | 25,812 |
| 052 125 020004 | S1 32616 (3X25+16) ISI BÜZÜŞMELİ | 1 ad. | | 38,566 |
| 052 125 020005 | S1 33516 (3X35+16) ISI BÜZÜŞMELİ | 1 ad. | | 41,812 |
| 052 125 020006 | S1 35025 (3X50+25) ISI BÜZÜŞMELİ | 1 ad. | | 45,057 |
| 052 125 020007 | S1 37035 (3X70+35) ISI BÜZÜŞMELİ | 1 ad. | | 67,548 |
| 052 125 020008 | S1 39550 (3X95+50) ISI BÜZÜŞMELİ | 1 ad. | | 73,661 |
| 052 125 020009 | S1 31207 (3X120+70) ISI BÜZÜŞMELİ | 1 ad. | | 96,227 |
| 052 125 020027 | S1 31507 (3X150+70) ISI BÜZÜŞMELİ | 1 ad. | | 118,642 |
| 052 125 020010 | S1 31859 (3X185+95) ISI BÜZÜŞMELİ | 1 ad. | | 193,586 |
| 052 125 020028 | S1 32401 (3X240+120) ISI BÜZÜŞMELİ | 1 ad. | | 202,492 |
| ISI İLE DARALAN MAKARONLAR | | | | |
| 065 141 030001 | 1,5 MM ISI İLE DARALAN MAKARON | 1 ad. | | 0,110 \$ |
| 065 141 030002 | 2,5 MM ISI İLE DARALAN MAKARON | 1 ad. | | 0,127 \$ |
| 065 141 030003 | 3 MM ISI İLE DARALAN MAKARON | 1 ad. | | 0,149 \$ |
| 065 141 030004 | 3,2 MM ISI İLE DARALAN MAKARON | 1 ad. | | 0,149 \$ |
| 065 141 030005 | 3,5 MM ISI İLE DARALAN MAKARON | 1 ad. | | 0,155 \$ |
| 065 141 030006 | 4 MM ISI İLE DARALAN MAKARON | 1 ad. | | 0,169 \$ |
| 065 141 030007 | 4,5 MM ISI İLE DARALAN MAKARON | 1 ad. | | 0,186 \$ |
| 065 141 030008 | 4,8 MM ISI İLE DARALAN MAKARON | 1 ad. | | 0,186 \$ |
| 065 141 030009 | 5 MM ISI İLE DARALAN MAKARON | 1 ad. | | 0,203 \$ |
| 065 141 030010 | 6 MM ISI İLE DARALAN MAKARON | 1 ad. | | 0,219 \$ |
| 065 141 030011 | 6,4 MM ISI İLE DARALAN MAKARON | 1 ad. | | 0,219 \$ |
| 065 141 030012 | 7 MM ISI İLE DARALAN MAKARON | 1 ad. | | 0,241 \$ |
| 065 141 030013 | 8 MM ISI İLE DARALAN MAKARON | 1 ad. | | 0,262 \$ |
| 065 141 030014 | 9,5 MM ISI İLE DARALAN MAKARON | 1 ad. | | 0,270 \$ |
| 065 141 030015 | 10 MM ISI İLE DARALAN MAKARON | 1 ad. | | 0,287 \$ |
| 065 141 030016 | 12,7 MM ISI İLE DARALAN MAKARON | 1 ad. | | 0,354 \$ |
| 065 141 030017 | 13 MM ISI İLE DARALAN MAKARON | 1 ad. | | 0,388 \$ |
| 065 141 030018 | 16 MM ISI İLE DARALAN MAKARON | 1 ad. | | 0,675 \$ |
| 065 141 030019 | 18 MM ISI İLE DARALAN MAKARON | 1 ad. | | 0,844 \$ |
| 065 141 030020 | 19,1 MM ISI İLE DARALAN MAKARON | 1 ad. | | 0,996 \$ |
| 065 141 030021 | 20 MM ISI İLE DARALAN MAKARON | 1 ad. | | 0,996 \$ |
| 065 141 030022 | 22 MM ISI İLE DARALAN MAKARON | 1 ad. | | 1,148 \$ |
| 065 141 030023 | 25 MM ISI İLE DARALAN MAKARON | 1 ad. | | 1,215 \$ |
| 065 141 030024 | 30 MM ISI İLE DARALAN MAKARON | 1 ad. | | 2,194 \$ |
| 065 141 030025 | 35 MM ISI İLE DARALAN MAKARON | 1 ad. | | 2,785 \$ |
| 065 141 030026 | 40 MM ISI İLE DARALAN MAKARON | 1 ad. | | 2,869 \$ |
| 065 141 030027 | 50 MM ISI İLE DARALAN MAKARON | 1 ad. | | 4,219 \$ |
| 065 141 030028 | 60 MM ISI İLE DARALAN MAKARON | 1 ad. | | 6,076 \$ |
| 065 141 030029 | 70 MM ISI İLE DARALAN MAKARON | 1 ad. | | 8,101 \$ |
| 065 141 030030 | 80 MM ISI İLE DARALAN MAKARON | 1 ad. | | 9,282 \$ |
| 065 141 030031 | 90 MM ISI İLE DARALAN MAKARON | 1 ad. | | 10,801 \$ |
| 065 141 030032 | 100 MM ISI İLE DARALAN MAKARON | 1 ad. | | 10,970 \$ |
| 065 141 030033 | 120 MM ISI İLE DARALAN MAKARON | 1 ad. | | 16,877 \$ |



Mutlusan Plastik Elektrik San. ve Tic. A.Ş.

İkitelli Org. San. Bölgesi Mah. Enkoop Cad. No:7

T. +90 (212) 485 05 44

F. +90 (212) 485 10 12

www.mutlusan.com.tr